

GravityTM

Analog ORP Sensor / Meter

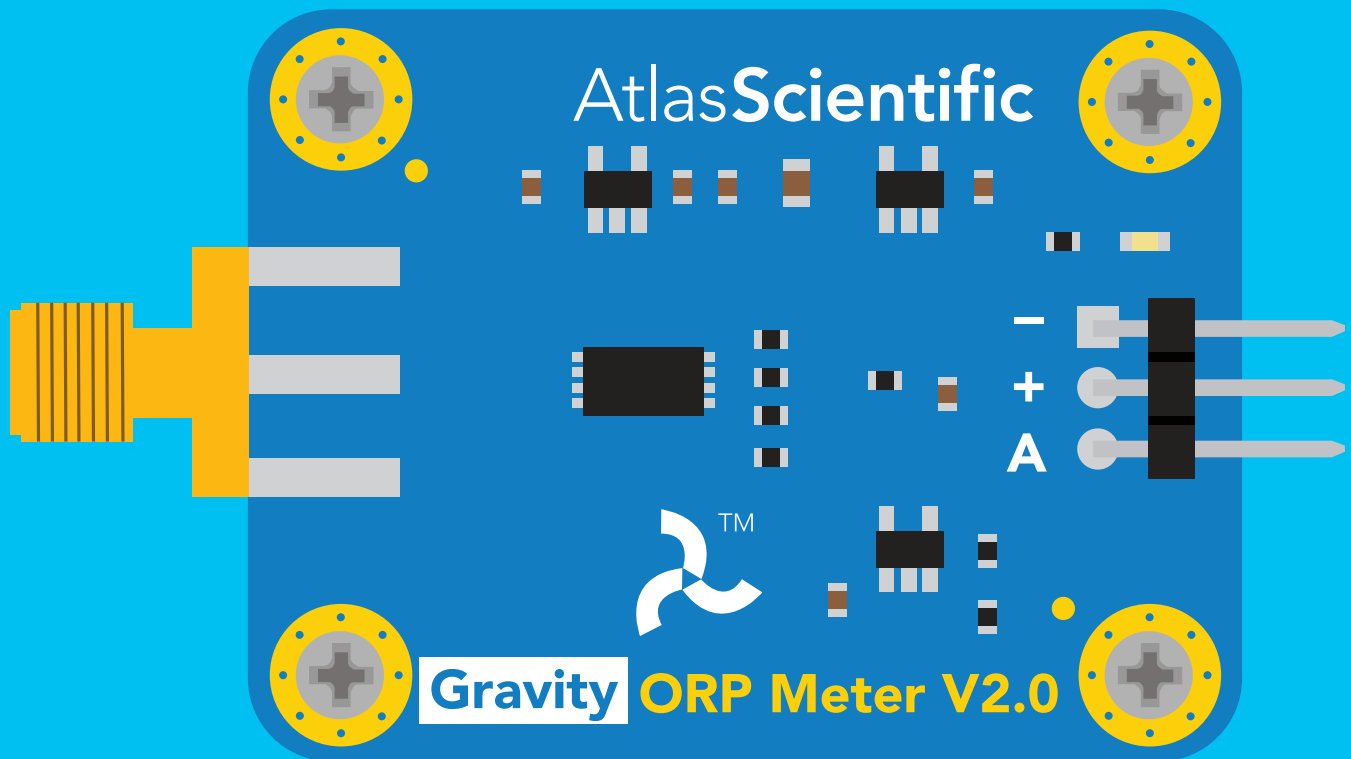

PATENT PROTECTED

Gravity dimensions

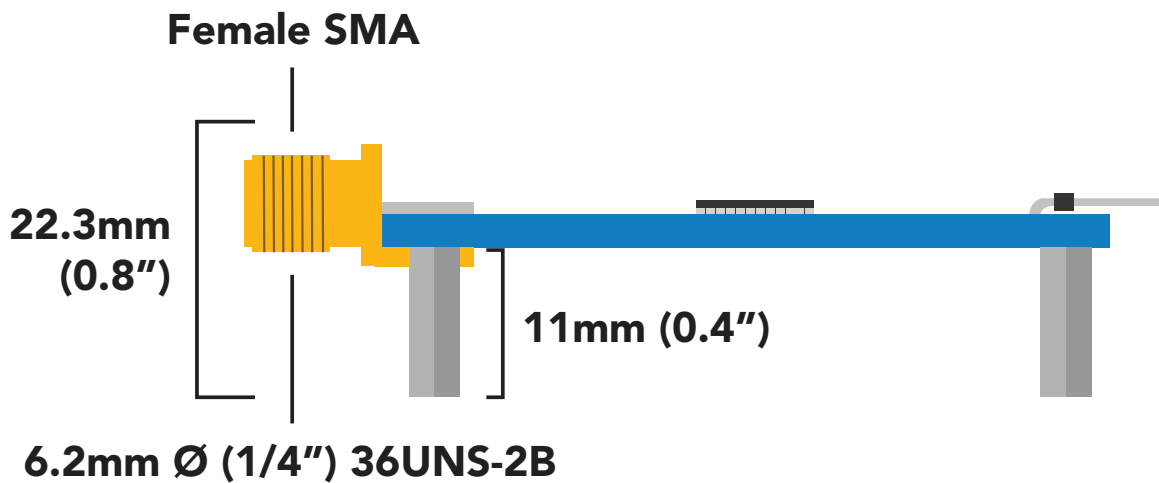
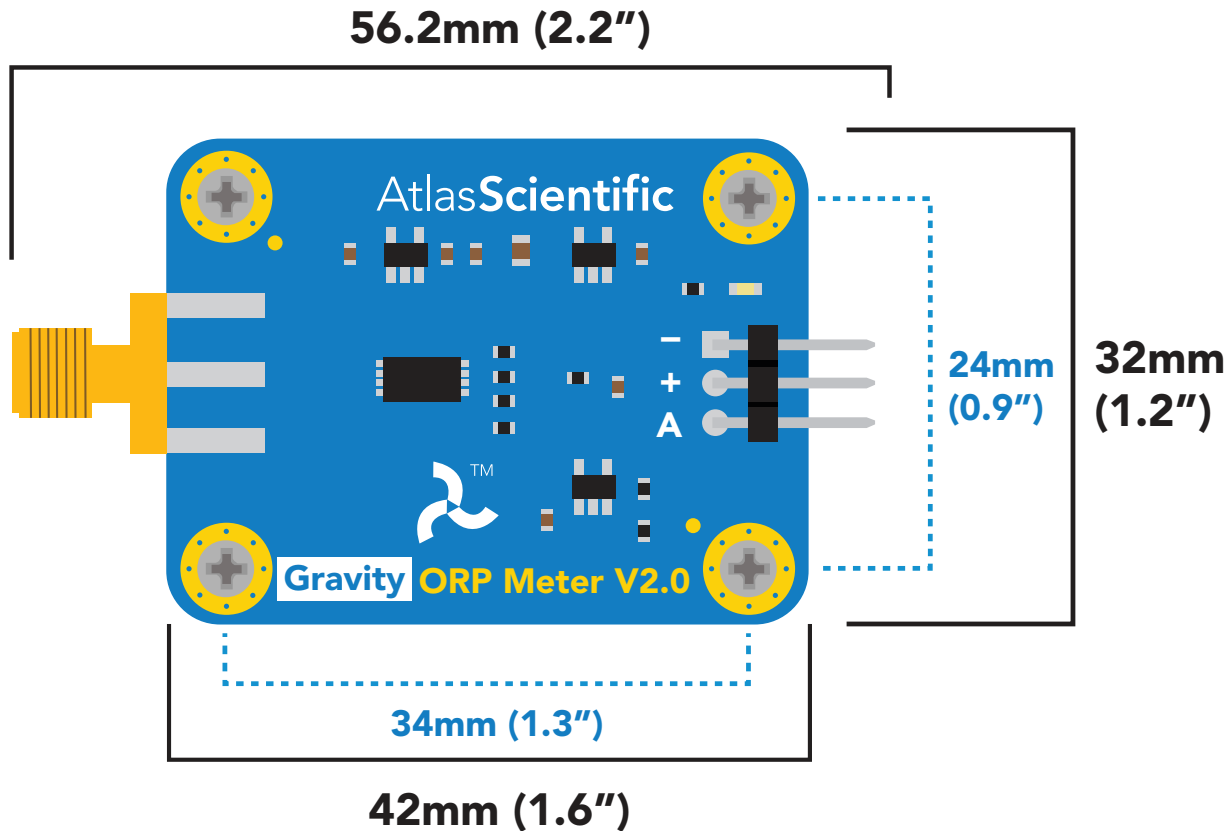

Power consumption

5V = 3mA
3.3V = 3mA

Absolute max ratings

Parameter	MIN	TYP	MAX
Storage temperature	-65 °C		125 °C
Operational temperature	-40 °C	25 °C	50 °C
VCC	3.3V	5V	5.5V

The Atlas Scientific Gravity™ Analog ORP Sensor / Meter is a low-cost solution specifically designed for

- **Students / education**
- **Proof of concept designs**
- **Moderate accuracy applications**

Connection pins

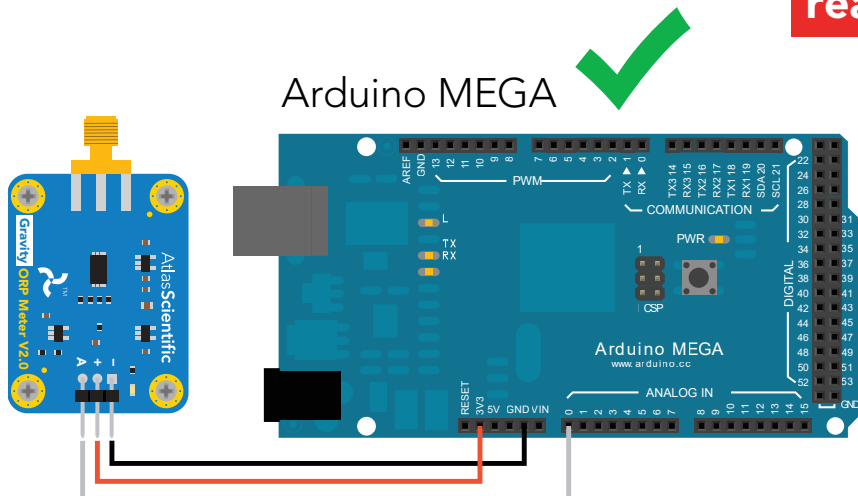
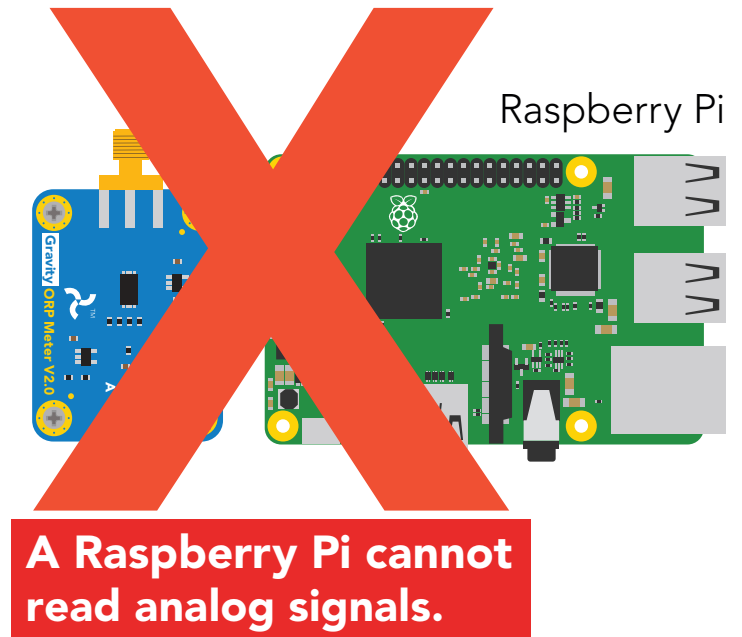
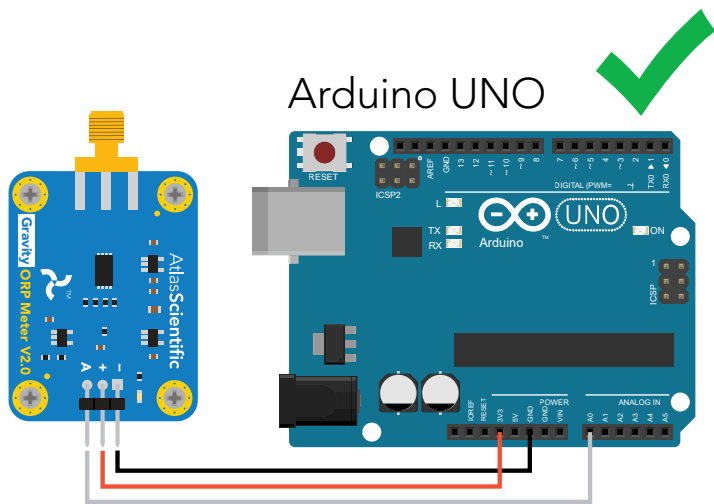
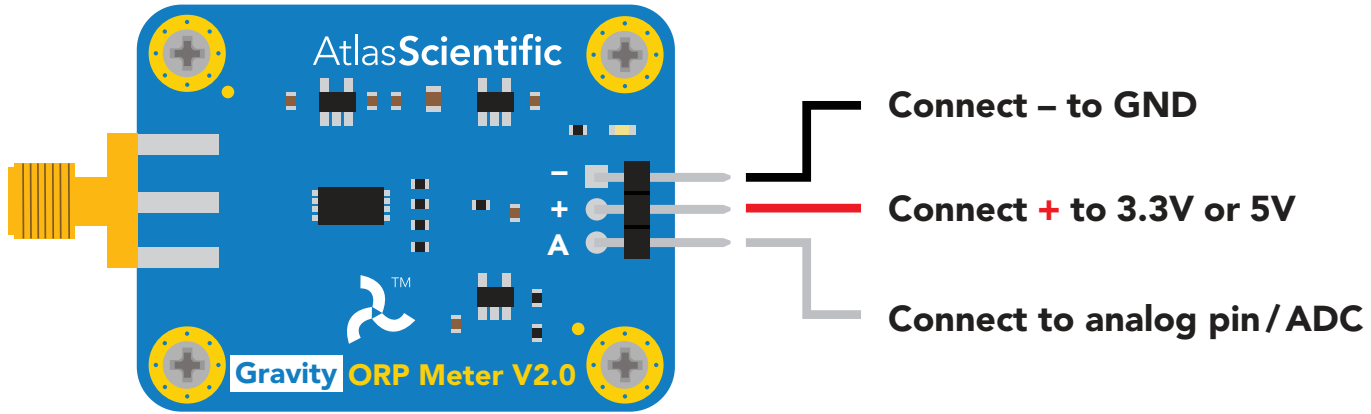

Converting the analog signal into ORP

The Atlas Scientific Gravity™ Analog ORP Sensor / Meter will output a voltage from 0V to 3.00V.

Equation to convert voltage to ORP

$$ORP = (voltage - 1500mV)$$

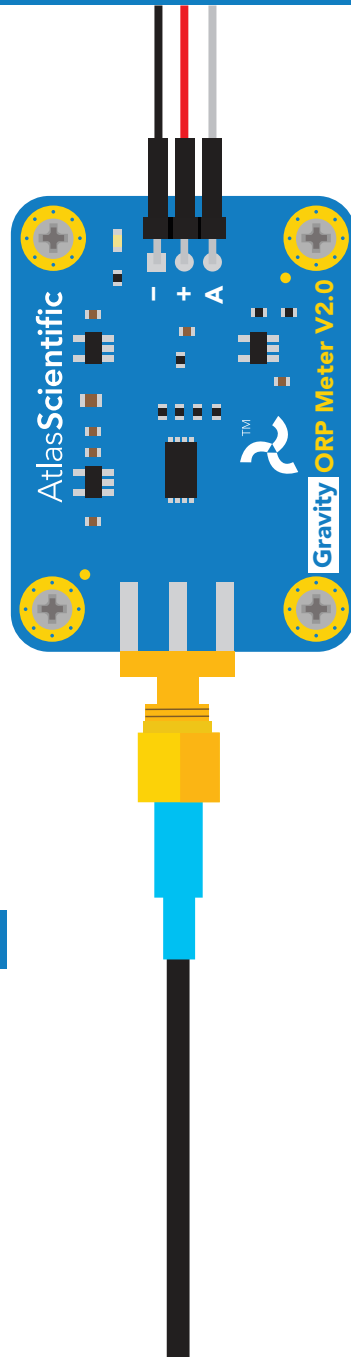
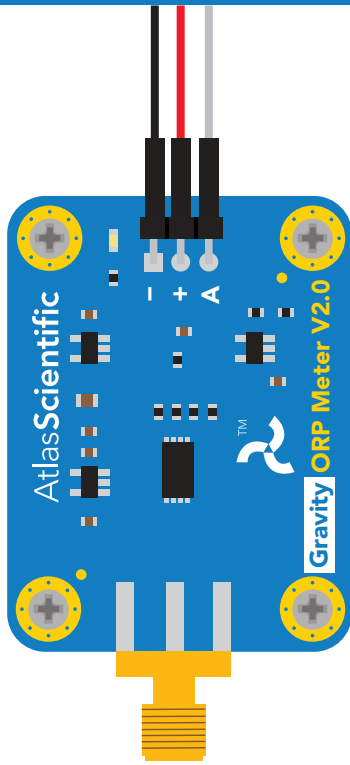

Tolerance $\pm .015V$

ORP **Volts**

+1500mV	3.0V
225mV	1.725V
0mV	1.5V
-1500mV	0V

No probe = Unpredictable

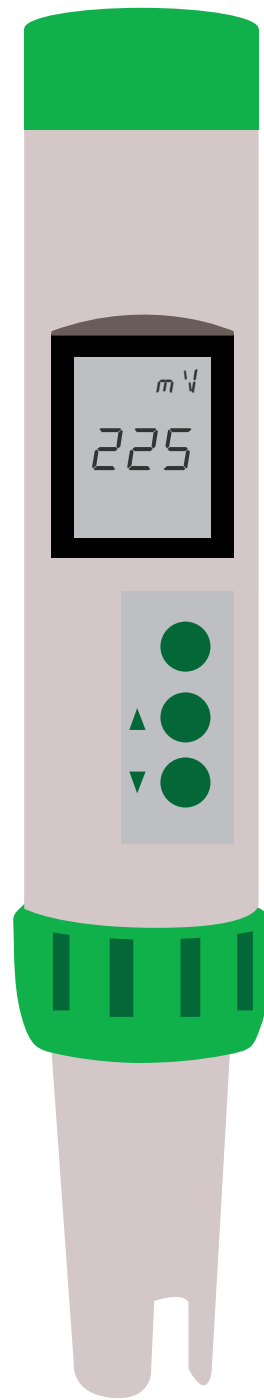
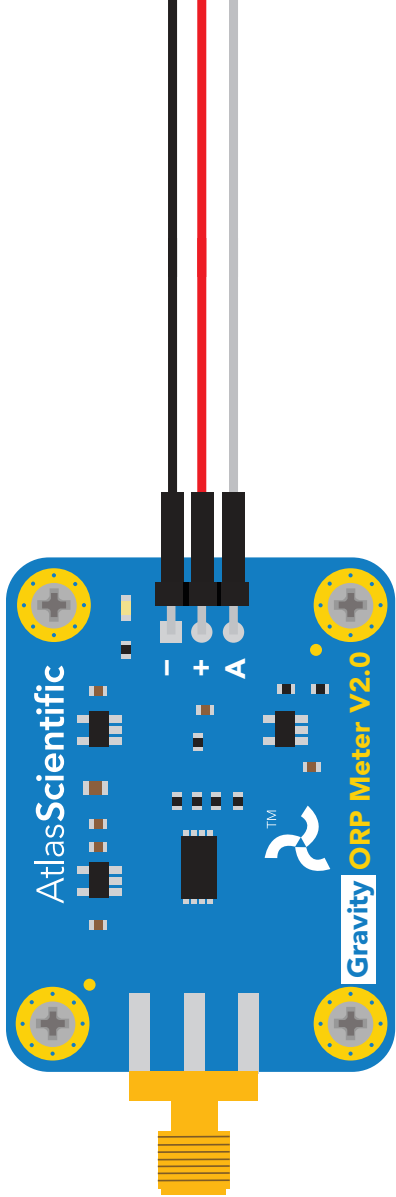

Accuracy

+/- 1mV

Life expectancy

~10 years

Accuracy

+/- 1mV

Life expectancy

~6 – 10 months

Electrical isolation

The Atlas Scientific Gravity™ Analog ORP Sensor / Meter is a very sensitive device and is susceptible to electrical interference from external sources. This interference is caused by micro-voltages entering the water from unnatural sources such as pumps, solenoid valves, or other probes / sensors. When electrical interference is affecting the ORP readings, it is common to see rapidly fluctuating readings or readings that are consistently off. To verify that electrical noise is causing inaccurate readings, place the ORP probe in a cup of water by itself. The readings should stabilize quickly, confirming that electrical noise was the issue.

To stop electrical interference from affecting the readings, Atlas Scientific **strongly recommends** using our [Gravity™ Analog Isolator](#). It is 100% effective at preventing electrical currents in the water from entering the probe and interfering with the readings.

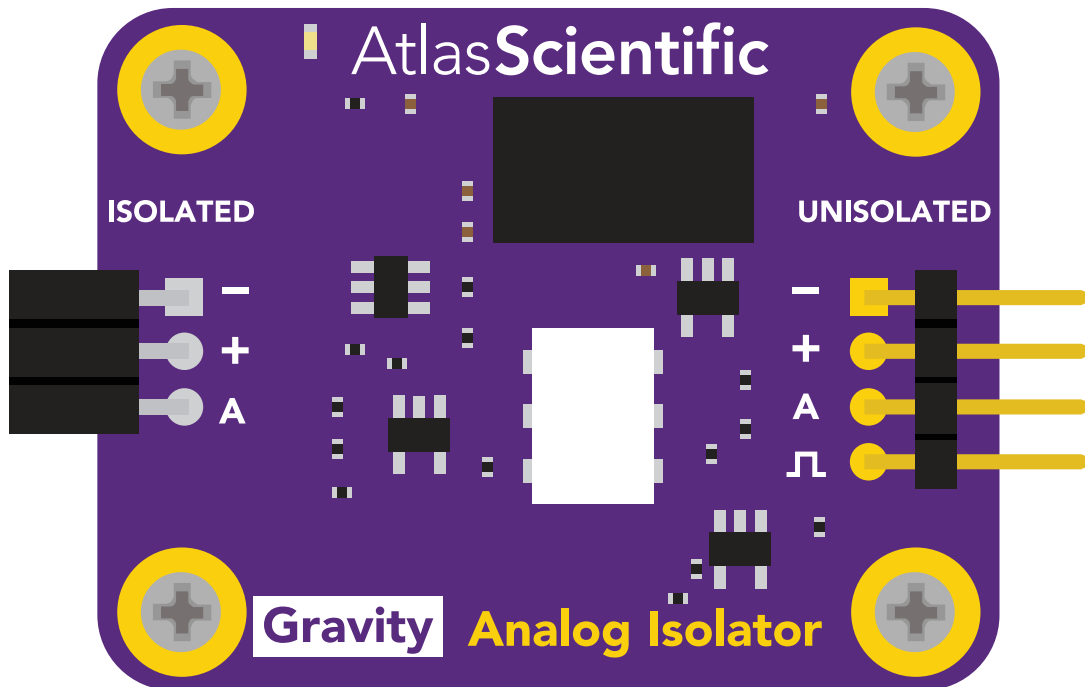

Refer to the [Gravity™ Analog Isolator datasheet](#) for more information about how the isolator works and how to use it.

Calibration

Using the [free downloadable arduino software](#), a one point calibration can be performed. The calibration procedure requires standard 225mV calibration buffers. Any brand of ORP quality calibration buffers can be used.

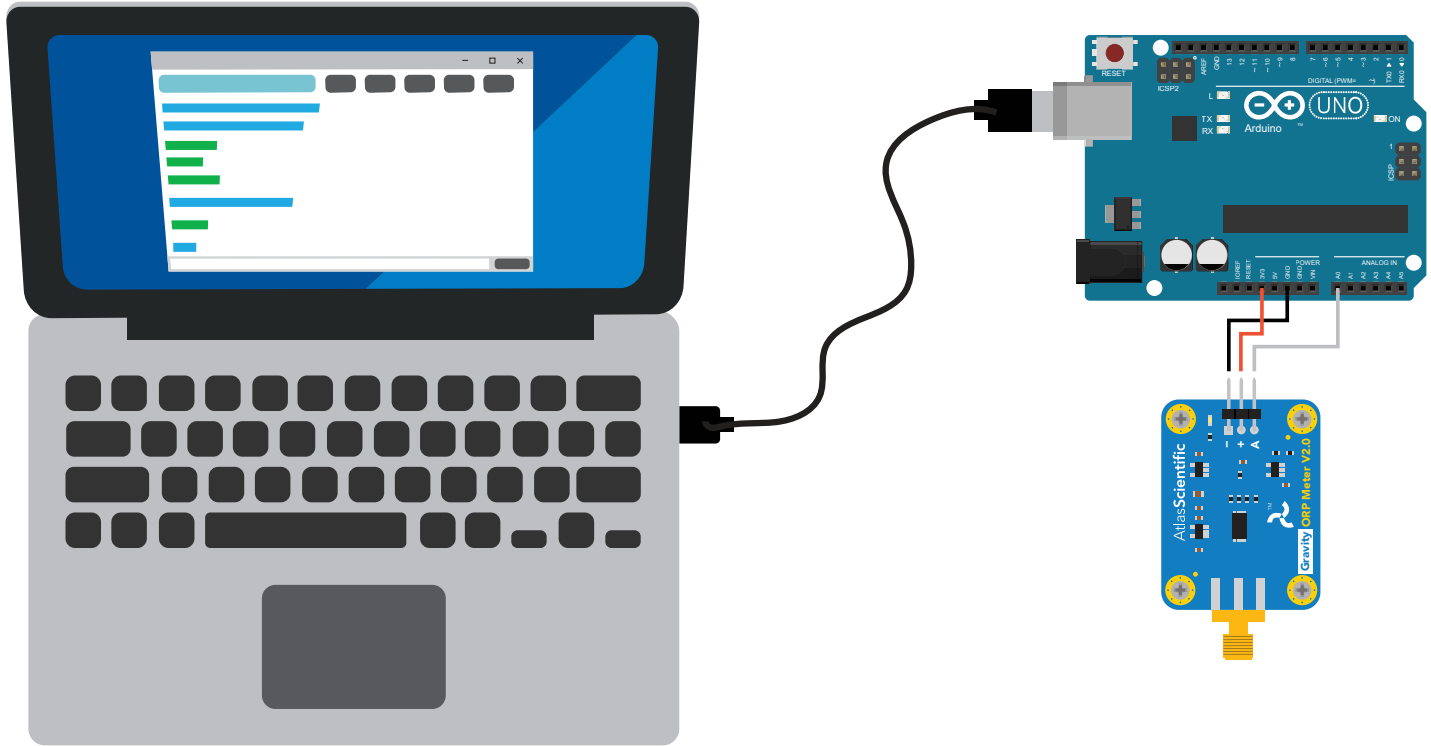

Higher accuracy

If more accuracy is required, Atlas Scientific offers a wide range of embedded ORP monitoring products that are significantly more accurate than this device.

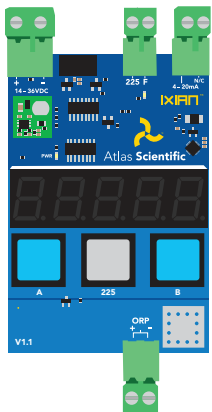

IXIAN-ORP™
ORP Transmitter

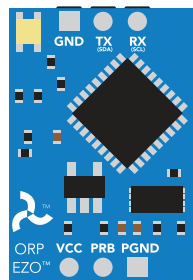

EZO-ORP™
Embedded ORP Circuit

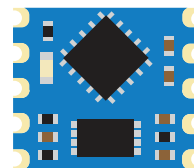

OEM-ORP™
Embedded ORP Circuit