

Base strip - MSTBV 2,5/ 9-GEH-5,08 - 1808531

Please be informed that the data shown in this PDF Document is generated from our Online Catalog. Please find the complete data in the user's documentation. Our General Terms of Use for Downloads are valid (<http://phoenixcontact.com/download>)

Header, Nominal current: 12 A, Rated voltage (III/2): 320 V, Number of positions: 9, Pitch: 5.08 mm, Color: green, Contact surface: Tin, Assembly: Soldering



The figure shows a 10-position version of the product

Product Features

- Versions with and without side panel
- Other pin lengths available on request
- Plug-in direction parallel and vertical to the PCB
- Standard pin strip for 320 V (III/2)



Key commercial data

Packing unit	1 pc
GTIN	 4 017918 047047
Weight per Piece (excluding packing)	5.2 GRM
Custom tariff number	85366990
Country of origin	Germany

Technical data

Dimensions

Length	8.6 mm
Pitch	5.08 mm
Dimension a	40.64 mm
Pin dimensions	1 x 1 mm
Hole diameter	1.4 mm

General

Base strip - MSTBV 2,5/ 9-GEH-5,08 - 1808531

Technical data

General

Range of articles	MSTBV 2,5/...-GEH
Insulating material group	IIIa
Rated surge voltage (III/3)	4 kV
Rated surge voltage (III/2)	4 kV
Rated surge voltage (II/2)	4 kV
Rated voltage (III/3)	250 V
Rated voltage (III/2)	320 V
Rated voltage (II/2)	400 V
Connection in acc. with standard	EN-VDE
Nominal current I_N	12 A
Maximum load current	12 A
Insulating material	PBT
Inflammability class according to UL 94	V0
Color	green
Number of positions	9

Classifications

eCl@ss

eCl@ss 4.0	272607xx
eCl@ss 4.1	27260701
eCl@ss 5.0	27260701
eCl@ss 5.1	27260701
eCl@ss 6.0	27260704
eCl@ss 7.0	27440402
eCl@ss 8.0	27440402

ETIM

ETIM 3.0	EC001121
ETIM 4.0	EC002637
ETIM 5.0	EC002637

UNSPSC

UNSPSC 6.01	30211810
UNSPSC 7.0901	39121409
UNSPSC 11	39121409
UNSPSC 12.01	39121409
UNSPSC 13.2	39121409

Base strip - MSTBV 2,5/ 9-GEH-5,08 - 1808531

Approvals

Approvals

Approvals

CSA / UL Recognized / VDE Gutachten mit Fertigungsüberwachung / cUL Recognized / IEC60335 CB Scheme / CSA / CCA / cULus Recognized

Ex Approvals

Approvals submitted

Approval details

CSA 		
	B	D
Nominal current I _N	12 A	10 A
Nominal voltage U _N	300 V	300 V

UL Recognized 		
	B	D
Nominal current I _N	12 A	10 A
Nominal voltage U _N	300 V	300 V

VDE Gutachten mit Fertigungsüberwachung 	
Nominal current I _N	12 A
Nominal voltage U _N	250 V

Base strip - MSTBV 2,5/ 9-GEH-5,08 - 1808531

Approvals

cUL Recognized		
	B	D
Nominal current IN	12 A	10 A
Nominal voltage UN	300 V	300 V

IECEE CB Scheme	
Nominal current IN	12 A
Nominal voltage UN	250 V

CSA		
	B	D
Nominal current IN	10 A	10 A
Nominal voltage UN	300 V	300 V

CCA	
Nominal current IN	12 A
Nominal voltage UN	250 V

cULus Recognized	
------------------	--

Drawings

Base strip - MSTBV 2,5/ 9-GEH-5,08 - 1808531

Drilling diagram

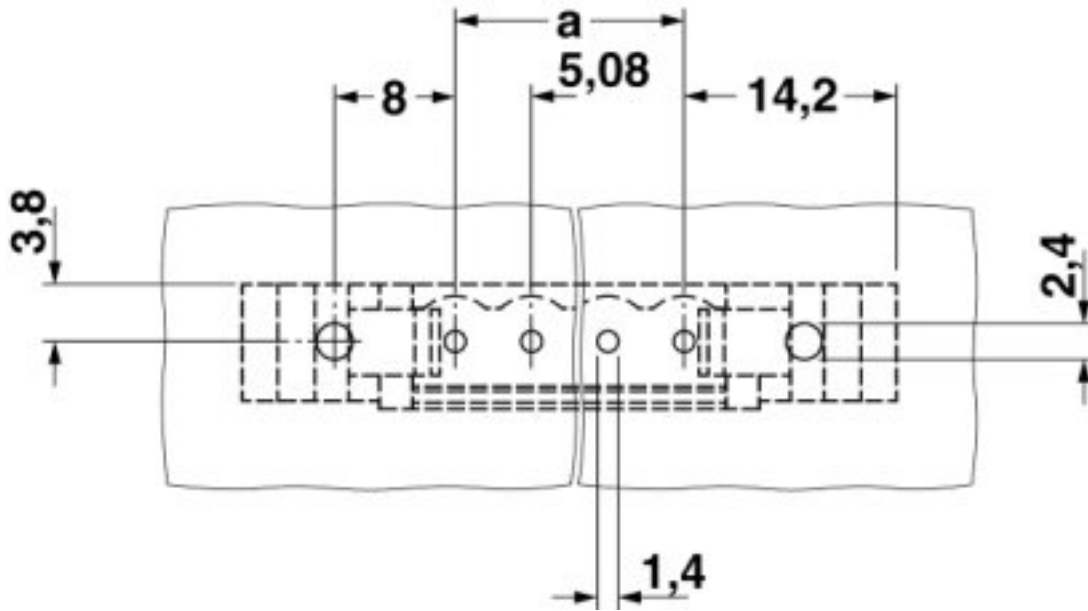

Dimensioned drawing

