

144297G1-C

ADTRAN® 144297G1 Compatible TAA 10GBase-CWDM XFP Transceiver (SMF, 1470nm, 80km, LC, DOM)

Features:

- INF-8077i Compliance
- Duplex LC Connector
- Single-mode Fiber
- Commercial Temperature 0 to 70 Celsius
- Hot Pluggable
- Metal with Lower EMI
- Excellent ESD Protection
- RoHS Compliant and Lead Free



Applications:

- 10x Gigabit Ethernet over CWDM
- 8x/10x Fibre Channel
- Access, Metro and Enterprise
- Mobile Fronthaul CPRI/OBSAI

Product Description

This ADTRAN® 144297G1 compatible XFP transceiver provides 10GBase-CWDM throughput up to 80km over single-mode fiber (SMF) using a wavelength of 1470nm via an LC connector. It is guaranteed to be 100% compatible with the equivalent ADTRAN® transceiver. This easy to install, hot swappable transceiver has been programmed, uniquely serialized and data-traffic and application tested to ensure that it will initialize and perform identically. Digital optical monitoring (DOM) support is also present to allow access to real-time operating parameters. This transceiver is Trade Agreements Act (TAA) compliant. We stand behind the quality of our products and proudly offer a limited lifetime warranty.

ProLabs' transceivers are RoHS compliant and lead-free.

TAA refers to the Trade Agreements Act (19 U.S.C. & 2501-2581), which is intended to foster fair and open international trade. TAA requires that the U.S. Government may acquire only "U.S. – made or designated country end products."



Regulatory Compliance

- ESD to the Electrical PINs: compatible with MIL-STD-883E Method 3015.4
- ESD to the LC Receptacle: compatible with IEC 61000-4-3
- EMI/EMC compatible with FCC Part 15 Subpart B Rules, EN55022:2010
- Laser Eye Safety compatible with FDA 21CFR, EN60950-1& EN (IEC) 60825-1,2
- RoHS compliant with EU RoHS 2.0 directive 2015/863/EU

CWDM Available Wavelengths

| Wavelengths | Min. | Typ. | Max. |
|-------------|--------|------|--------|
| 1470 | 1463.5 | 1470 | 1476.5 |
| 1490 | 1483.5 | 1490 | 1496.5 |
| 1510 | 1503.5 | 1510 | 1516.5 |
| 1530 | 1523.5 | 1530 | 1536.5 |
| 1550 | 1543.5 | 1550 | 1556.5 |
| 1570 | 1563.5 | 1570 | 1576.5 |
| 1590 | 1583.5 | 1590 | 1596.5 |
| 1610 | 1603.5 | 1610 | 1616.5 |

Absolute Maximum Ratings

| Parameter | Symbol | Min. | Max. | Unit |
|------------------------|------------------|------|------|------|
| Maximum Supply Voltage | Vcc3 | -0.5 | 3.6 | V |
| | Vcc5 | -0.5 | 6 | V |
| Storage Temperature | TS | -40 | 85 | °C |
| Operating Temperature | TO | -5 | 70 | °C |
| Operating Humidity | RH | 5 | 85 | % |
| Receiver power | R _{MAX} | | -7 | dBm |
| Maximum bitrate | B _{max} | | 11.3 | Gbps |

Electrical Characteristics (TOP=25°C, Vcc=3.3Volts)

| Parameter | Symbol | Min. | Typ. | Max. | Unit | Notes |
|--------------------------------|----------------------|------|------|------|------|-------|
| Power Supply Voltage | Vcc3 | 3.15 | 3.30 | 3.43 | V | |
| | Vcc5 | 4.75 | 5.0 | 5.25 | V | |
| Power Supply Current | Icc | | | 1061 | mA | |
| Power Consumption | P _{DISS} | | | 3.5 | W | |
| Transmitter | | | | | | |
| Differential data input swing | V _{in,pp} | 120 | | 850 | mV | |
| Input differential impedance | Z _{in} | 80 | 100 | 120 | Ω | |
| Receiver | | | | | | |
| Differential data output swing | V _{out, pp} | 300 | | 850 | mV | |
| Output differential impedance | Z _{in} | 80 | 100 | 120 | Ω | |

Optical Characteristics

| Parameter | Symbol | Min. | Typ. | Max. | Unit | Notes |
|------------------------------------|------------------|-------|------|-------|------|-------|
| Transmitter | | | | | | |
| Optical Power (average) | P _{AVE} | 0 | | 4 | dBm | 1 |
| Transmitter and Dispersion Penalty | TDP | | | 3.5 | dB | |
| Optical Extinction Ratio | ER | 9 | | | dB | |
| Optical Wavelength | Tλ | x-6.5 | x | x+6.5 | nm | |
| Insertion loss | IL | | 0.35 | | | |
| Receiver | | | | | | |
| Receiver Sensitivity (average) | R _{AVE} | | | -23 | dBm | 2 |
| Receiver overload | P _{max} | -8 | | | dBm | 3 |
| Receiver wavelength | Rλ | 1260 | | 1620 | nm | |

Notes:

1. Coupled into a Single mode fibre
2. Average power, back-to-back, @10.31Gbps, BER 1E⁻¹², PRBS 2³¹-1.
3. Exceeding the Receiver overload can physically damage the module. Please use appropriate attenuation.

Pin Descriptions

| Pin | Symbol | Name/Descriptions | Ref. |
|-----|------------|---|------|
| 1 | GND | Module Ground | |
| 2 | Vee5 | (not required) | |
| 3 | MOD_DESEL | Module De-select; When Held low allows the module to respond to 2-wire serial interface. LVTTTL-I | |
| 4 | /INTERRUPT | Interrupt; Indicates presence of an important condition which can be read via the 2-wire serial interface. LVTTTL-O | 2 |
| 5 | TX_DIS | Transmitter Disable. Logic1 indicates laser output disabled, LVTTTL-I | |
| 6 | VCC5 | +5V Power Supply (Not required) | |
| 7 | GND | Module Ground | 1 |
| 8 | VCC3 | +3.3V Power Supply | |
| 9 | VCC3 | +3.3V Power Supply | |
| 10 | SCL | 2-Wire Serial Interface Clock. LVTTTL-I | 2 |
| 11 | SDA | 2-Wire Serial Interface Data Line. LVTTTL-I/O | 2 |
| 12 | MOD_Abs | Indicates Module is not present. Grounded in the Module. LVTTTL-O | 2 |
| 13 | MOD_NR | Module Not Ready; Indicating Module Operational Fault. Open-collector. LVTTTL-O | 2 |
| 14 | RX_LOS | Loss of Signal indication. Logic 1 indicates loss of Signal. Open-collector. LVTTTL-O | 2 |
| 15 | GND | Module Ground | 1 |
| 16 | GND | Module Ground | 1 |
| 17 | RD- | Receiver Inverted Data Output. CML-O | |
| 18 | RD+ | Receiver Non-Inverted Data Output. CML-O | |
| 19 | GND | Module Ground | 1 |
| 20 | VCC2 | +1.8V Power Supply (Not required). | 3 |
| 21 | P_DOWN/RST | Power down; When high, requires the module to limit power consumption to 1.5W or below. 2-Wire serial interface must be functional in the low power mode. LVTTTL-I Reset; The falling edge initiates a complete reset of the module including the 2-wire serial interface, equivalent to a power cycle. LVTTTL-I | |
| 22 | VCC2 | +1.8V Power Supply (Not required) | 3 |
| 23 | GND | Module Ground | 1 |
| 24 | REFCLK+ | Reference Clock (Not required) | |
| 25 | REFCLK- | Reference Clock (Not required) | |
| 26 | GND | Module Ground | 1 |
| 27 | GND | Module Ground | 1 |
| 28 | TD- | Transmitter Inverted Data Input. CML-I | |
| 29 | TD+ | Transmitter Non-Inverted Data Input. CML-I | |
| 30 | GND | Module Ground | 1 |

Notes:

1. Module ground pins GND are isolated from the module case and chassis ground within the module.
2. Open collector; should be pulled up with 4.7K-10Kohms to a voltage between 3.15V and 3.6V on the host board.
3. The pins are open within module.



Pin-out of connector Block on Host board

Recommended Circuit Schematic



Mechanical Specifications

Small Form Factor Pluggable (XFP) transceivers are compatible with the dimensions defined by the XFP Multi-Sourcing Agreement (MSA).

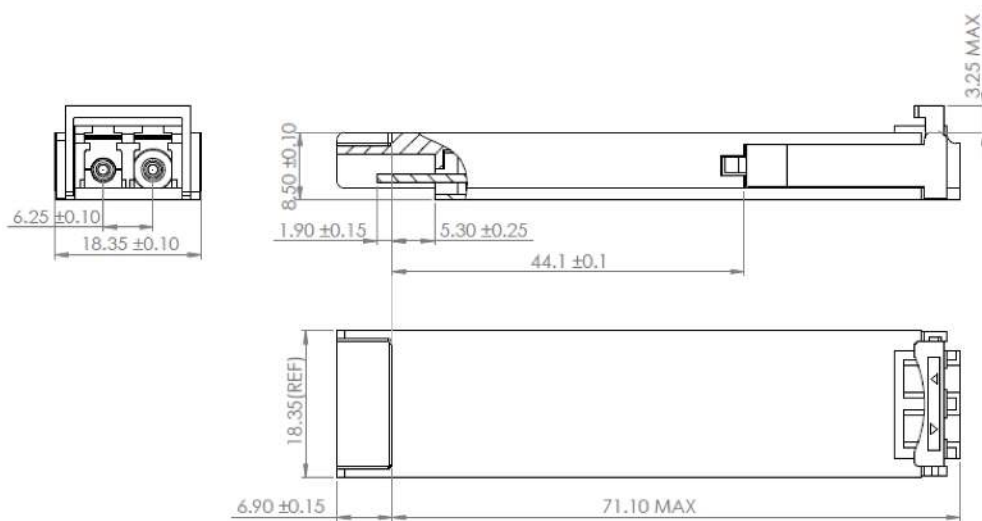

EEPROM Information

Management Interface

XFP 2-wire serial interface is specified in the Chapter 4 of the XFP MSA specification. The XFP 2-wire serial interface is used for serial ID, digital diagnostics, and certain control functions. The 2-wire serial interface is mandatory for all XFP modules. The 2-wire serial interface address of the XFP module is 1010000X(A0h). In order to access to multiple modules on the same 2-wire serial bus, the XFP has a MOD_DESEL(module deselect pin). This pin (which is pull high or deselected in the module) must be held low by the host to select of interest and allow communication over 2-wire serial interface. The module must not respond to or accept 2-wire serial bus instructions unless it is selected.

XFP Management Interface

XFP Management interface is specified in the Chapter 5 of the XFP MSA specification. The Figure 1 shows the structure of the memory map. The normal 256 Byte address space is divided into lower and upper blocks of 128 Bytes. The lower block of 128 Byte is always directly available and is used for the diagnostics and control functions that must be accessed repeatedly. Multiple blocks of memories are available in the upper 128 Bytes of the address space. These are individually addressed through a table select Byte which the user enters into a location in the lower address space. The upper address space tables are used for less frequently accessed functions and control space for future standards definition.

EEPROM memory map specific data field description is as below:



About ProLabs

Our experience comes as standard; for over 15 years ProLabs has delivered optical connectivity solutions that give our customers freedom and choice through our ability to provide seamless interoperability. At the heart of our company is the ability to provide state-of-the-art optical transport and connectivity solutions that are compatible with over 90 optical switching and transport platforms.

Complete Portfolio of Network Solutions

ProLabs is focused on innovations in optical transport and connectivity. The combination of our knowledge of optics and networking equipment enables ProLabs to be your single source for optical transport and connectivity solutions from 100Mb to 400G while providing innovative solutions that increase network efficiency. We provide the optical connectivity expertise that is compatible with and enhances your switching and transport equipment.

Trusted Partner

Customer service is our number one value. ProLabs has invested in people, labs and manufacturing capacity to ensure that you get immediate answers to your questions and compatible product when needed. With Engineering and Manufacturing offices in the U.K. and U.S. augmented by field offices throughout the U.S., U.K. and Asia, ProLabs is able to be our customers best advocate 24 hours a day.

Contact Information

ProLabs US

Email: sales@prolabs.com

Telephone: 952-852-0252

ProLabs UK

Email: salessupport@prolabs.com

Telephone: +44 1285 719 600