

National Semiconductor is now part of
Texas Instruments.

Search <http://www.ti.com/> for the latest technical
information and details on our current products and services.

LP2986

Micropower, 200 mA Ultra Low-Dropout Fixed or Adjustable Voltage Regulator

General Description

The LP2986 is a 200 mA precision LDO voltage regulator which offers the designer a higher performance version of the industry standard LP2951.

Using an optimized VIP™ (Vertically Integrated PNP) process, the LP2986 delivers superior performance:

Dropout Voltage: Typically 180 mV @ 200 mA load, and 1 mV @ 1 mA load.

Ground Pin Current: Typically 1 mA @ 200 mA load, and 200 μ A @ 10 mA load.

Sleep Mode: The LP2986 draws less than 1 μ A quiescent current when shutdown pin is pulled low.

Error Flag: The built-in error flag goes low when the output drops approximately 5% below nominal.

Precision Output: The standard product versions available can be pin-strapped (using the internal resistive divider) to provide output voltages of 5.0V, 3.3V, or 3.0V with guaranteed accuracy of 0.5% ("A" grade) and 1% (standard grade) at room temperature.

Features

- Ultra low dropout voltage
- Guaranteed 200 mA output current
- SO-8 and mini-SO8 surface mount packages
- <1 μ A quiescent current when shutdown
- Low ground pin current at all loads
- 0.5% output voltage accuracy ("A" grade)
- High peak current capability (400 mA typical)
- Wide supply voltage range (16V max)
- Overtemperature/overcurrent protection
- -40°C to +125°C junction temperature range

Applications

- Cellular Phone
- Palmtop/Laptop Computer
- Camcorder, Personal Stereo, Camera

Block Diagram

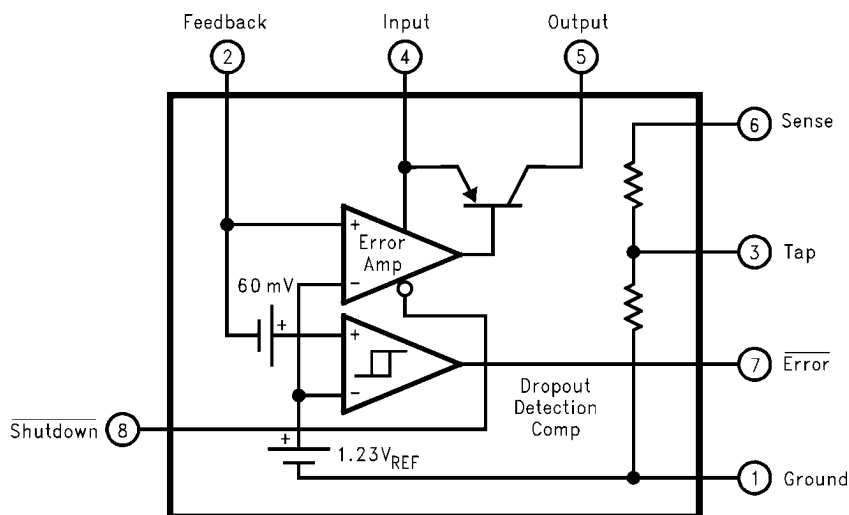

1293501

Connection Diagrams

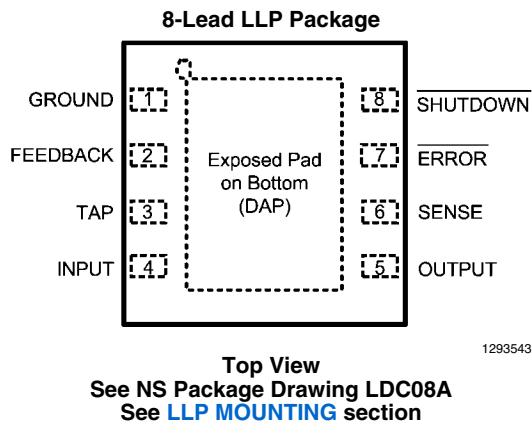
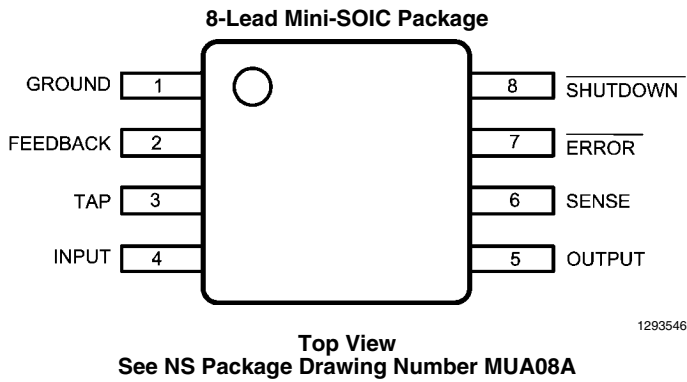
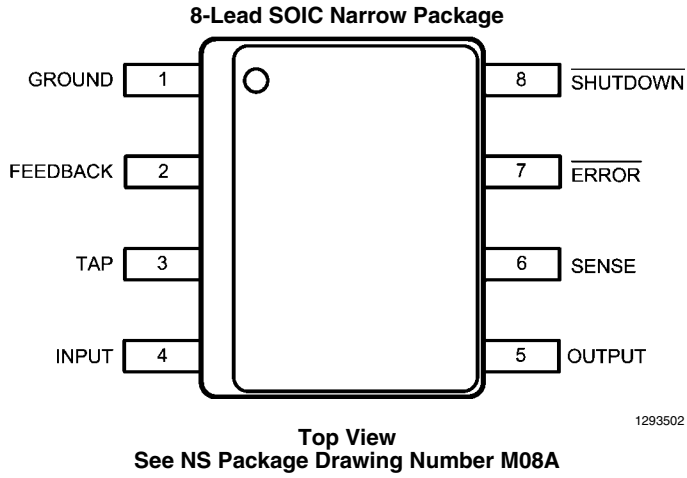

Ordering Information

TABLE 1. Package Marking and Ordering Information

Output Voltage	Grade	Order Information	Package Marking	Supplied as:
Mini SO-8				
5	A	LP2986AIMMX-5.0	L41A	3500 Units on Tape and Reel
5	A	LP2986AIMM-5.0	L41A	1000 Units on Tape and Reel
5	STD	LP2986IMMX-5.0	L41B	3500 Units on Tape and Reel
5	STD	LP2986IMM-5.0	L41B	1000 Units on Tape and Reel
3.3	A	LP2986AIMMX-3.3	L40A	3500 Units on Tape and Reel
3.3	A	LP2986AIMM-3.3	L40A	1000 Units on Tape and Reel
3.3	STD	LP2986IMMX-3.3	L40B	3500 Units on Tape and Reel
3.3	STD	LP2986IMM-3.3	L40B	1000 Units on Tape and Reel
3.0	A	LP2986AIMMX-3.0	L39A	3500 Units on Tape and Reel
3.0	A	LP2986AIMM-3.0	L39A	1000 Units on Tape and Reel
3.0	STD	LP2986IMMX-3.0	L39B	3500 Units on Tape and Reel
3.0	STD	LP2986IMM-3.0	L39B	1000 Units on Tape and Reel
SO-8				
5	A	LP2986AIMX-5.0	2986AIM5.0	2500 Units on Tape and Reel
5	A	LP2986AIM-5.0	2986AIM5.0	Shipped in Anti-Static Rails
5	STD	LP2986IMX-5.0	2986IM5.0	2500 Units on Tape and Reel
5	STD	LP2986IM-5.0	2986IM5.0	Shipped in Anti-Static Rails
3.3	A	LP2986AIMX-3.3	2986AIM3.3	2500 Units on Tape and Reel
3.3	A	LP2986AIM-3.3	2986AIM3.3	Shipped in Anti-Static Rails
3.3	STD	LP2986IMX-3.3	2986IM3.3	2500 Units on Tape and Reel
3.3	STD	LP2986IM-3.3	2986IM3.3	Shipped in Anti-Static Rails
3.0	A	LP2986AIMX-3.0	2986AIM3.0	2500 Units on Tape and Reel
3.0	A	LP2986AIM-3.0	2986AIM3.0	Shipped in Anti-Static Rails
3.0	STD	LP2986IMX-3.0	2986IM3.0	2500 Units on Tape and Reel
3.0	STD	LP2986IM-3.0	2986IM3.0	Shipped in Anti-Static Rails
8-Lead LLP				
5	A	LP2986AILD-5	L006A	1000 Units on Tape and Reel
5	A	LP2986AILDX-5	L006A	4500 Units on Tape and Reel
5	STD	LP2986ILD-5	L006AB	1000 Units on Tape and Reel
5	STD	LP2986ILD-5	L006AB	4500 Units on Tape and Reel
3.3	A	LP2986AILD-3.3	L005A	1000 Units on Tape and Reel
3.3	A	LP2986AILDX-3.3	L005A	4500 Units on Tape and Reel
3.3	STD	LP2986ILD-3.3	L005AB	1000 Units on Tape and Reel
3.3	STD	LP2986ILD-3.3	L005AB	4500 Units on Tape and Reel
3.0	A	LP2986AILD-3.0	L004A	1000 Units on Tape and Reel
3.0	A	LP2986AILDX-3.0	L004A	4500 Units on Tape and Reel
3.0	STD	LP2986ILD-3.0	L004AB	1000 Units on Tape and Reel
3.0	STD	LP2986ILD-3.0	L004AB	4500 Units on Tape and Reel

For LP2986 Ordering and Availability Information see: <http://www.national.com/mpf/LP/LP2986.html#Order>

Absolute Maximum Ratings (Note 1)

If Military/Aerospace specified devices are required, please contact the National Semiconductor Sales Office/Distributors for availability and specifications.

Storage Temperature Range	-65°C to +150°C
Operating Junction Temperature Range	-40°C to +125°C
Lead Temperature (Soldering, 5 seconds)	260°C
ESD Rating (Note 2)	2 kV
Power Dissipation (Note 3)	Internally Limited

Input Supply Voltage (Survival)	-0.3V to +16V
Input Supply Voltage (Operating)	2.1V to +16V
Shutdown Pin	-0.3V to +16V
Feedback Pin	-0.3V to +5V
Output Voltage (Survival) (Note 4)	-0.3V to +16V
I _{OUT} (Survival)	Short Circuit Protected
Input-Output Voltage (Survival) (Note 5)	-0.3V to +16V

Electrical Characteristics

Limits in standard typeface are for T_J = 25°C, and limits in **boldface type** apply over the full operating temperature range. Unless otherwise specified: V_{IN} = V_O(NOM) + 1V, I_L = 1 mA, C_{OUT} = 4.7 μF, C_{IN} = 2.2 μF, V_{SD} = 2V.

Symbol	Parameter	Conditions	Typical	LM2986AI-X.X (Note 6)		LM2986I-X.X (Note 6)		Units
				Min	Max	Min	Max	
V _O	Output Voltage (5.0V Versions)		5.0	4.975	5.025	4.950	5.050	V
		0.1 mA < I _L < 200 mA	5.0	4.960	5.040	4.920	5.080	
				4.910	5.090	4.860	5.140	
	Output Voltage (3.3V Versions)		3.3	3.283	3.317	3.267	3.333	
		0.1 mA < I _L < 200 mA	3.3	3.274	3.326	3.247	3.353	
				3.241	3.359	3.208	3.392	
Output Voltage (3.0V Versions)		3.0	2.985	3.015	2.970	3.030		
	0.1 mA < I _L < 200 mA	3.0	2.976	3.024	2.952	3.048		
			2.946	3.054	2.916	3.084		
$\frac{V_O}{\Delta V_{IN}}$	Output Voltage Line Regulation	V _O (NOM) + 1V ≤ V _{IN} ≤ 16V	0.007		0.014		0.014	%V
					0.032		0.032	
V _{IN} -V _O	Dropout Voltage (Note 7)	I _L = 100 μA	1		2.0		2.0	mV
					3.5		3.5	
		I _L = 75 mA	90		120		120	
					170		170	
I _{GND}	Ground Pin Current	I _L = 100 μA	100		120		120	μA
					150		150	
		I _L = 75 mA	500		800		800	
					1400		1400	
I _O (PK)	Peak Output Current	V _{OUT} ≥ V _O (NOM) - 5%	400	250		250		mA
I _O (MAX)	Short Circuit Current	R _L = 0 (Steady State) (Note 11)	400					
e _n	Output Noise Voltage (RMS)	BW = 300 Hz to 50 kHz, C _{OUT} = 10 μF	160					μV(RMS)
$\frac{\Delta V_{OUT}}{\Delta V_{IN}}$	Ripple Rejection	f = 1 kHz, C _{OUT} = 10 μF	65					dB
$\frac{\Delta V_{OUT}}{\Delta T}$	Output Voltage Temperature Coefficient	(Note 9)	20					ppm/°C

Symbol	Parameter	Conditions	Typical	LM2986AI-X.X (Note 6)		LM2986I-X.X (Note 6)		Units
				Min	Max	Min	Max	
FEEDBACK PIN								
V_{FB}	Feedback Pin Voltage		1.23	1.21	1.25	1.20	1.26	V
		(Note 10)	1.23	1.20	1.26	1.19	1.27	
$\frac{\Delta V_{FB}}{\Delta T}$	FB Pin Voltage Temperature Coefficient	(Note 9)	20					ppm/°C
I_{FB}	Feedback Pin Bias Current	$I_L = 200 \text{ mA}$	150		330		330	nA
					760		760	
$\frac{I_{FB}}{\Delta T}$	FB Pin Bias Current Temperature Coefficient	(Note 9)	0.1					nA/°C
SHUTDOWN INPUT								
$V_{S/D}$	S/D Input Voltage (Note 8)	$V_H = \text{O/P ON}$	1.4	1.6		1.6		V
		$V_L = \text{O/P OFF}$	0.55		0.18		0.18	
$I_{S/D}$	S/D Input Current	$V_{S/D} = 0$	0		-1		-1	μA
		$V_{S/D} = 5\text{V}$	5		15		15	
ERROR COMPARATOR								
I_{OH}	Output "HIGH" Leakage	$V_{OH} = 16\text{V}$	0.01		1		1	μA
					2		2	
V_{OL}	Output "LOW" Voltage	$V_{IN} = V_O(\text{NOM}) - 0.5\text{V}$, $I_O(\text{COMP}) = 300 \mu\text{A}$	150		220		220	mV
					350		350	
$V_{THR}(\text{MAX})$	Upper Threshold Voltage		-4.6	-5.5	-3.5	-5.5	-3.5	% V_{OUT}
				-7.7	-2.5	-7.7	-2.5	
$V_{THR}(\text{MIN})$	Lower Threshold Voltage		-6.6	-8.9	-4.9	-8.9	-4.9	
				-13.0	-3.3	-13.0	-3.3	
HYST	Hysteresis		2.0					

Note 1: Absolute Maximum Ratings indicate limits beyond which damage to the component may occur. Electrical specifications do not apply when operating the device outside of its rated operating conditions.

Note 2: The ESD rating of the Feedback pin is 500V. The ESD rating of the V_{IN} pin is 1kV and the Tap pin is 1.5 kV.

Note 3: The maximum allowable power dissipation is a function of the maximum junction temperature, $T_J(\text{MAX})$, the junction-to-ambient thermal resistance, θ_{JA} , and the ambient temperature, T_A . The maximum allowable power dissipation at any ambient temperature is calculated using:

$$P(\text{MAX}) = \frac{T_J(\text{MAX}) - T_A}{\theta_{JA}}$$

The value of θ_{JA} for the SO-8 (M) package is 160°C/W, and the mini SO-8 (MM) package is 200°C/W. The value θ_{JA} for the LLP (LD) package is specifically dependent on PCB trace area, trace material, and the number of layers and thermal vias. For improved thermal resistance and power dissipation for the LLP package, refer to Application Note AN-1187. Exceeding the maximum allowable power dissipation will cause excessive die temperature, and the regulator will go into thermal shutdown.

Note 4: If used in a dual-supply system where the regulator load is returned to a negative supply, the LM2986 output must be diode-clamped to ground.

Note 5: The output PNP structure contains a diode between the V_{IN} and V_{OUT} terminals that is normally reverse-biased. Forcing the output above the input will turn on this diode and may induce a latch-up mode which can damage the part (see Application Hints).

Note 6: Limits are 100% production tested at 25°C. Limits over the operating temperature range are guaranteed through correlation using Statistical Quality Control (SQC) methods. The limits are used to calculate National's Average Outgoing Quality Level (AOQL).

Note 7: Dropout voltage is defined as the input to output differential at which the output voltage drops 100 mV below the value measured with a 1V differential.

Note 8: To prevent mis-operation, the Shutdown input must be driven by a signal that swings above V_H and below V_L with a slew rate not less than 40 mV/ μs (see Application Hints).

Note 9: Temperature coefficient is defined as the maximum (worst-case) change divided by the total temperature range.

Note 10: $V_{FB} \leq V_{OUT} \leq (V_{IN} - 1)$, $2.5\text{V} \leq V_{IN} \leq 16\text{V}$, $100 \mu\text{A} \leq I_L \leq 200 \text{ mA}$, $T_J \leq 125^\circ\text{C}$.

Note 11: See Typical Performance Characteristics curves.

Typical Performance Characteristics

Unless otherwise specified: $T_A = 25^\circ\text{C}$, $C_{OUT} = 4.7 \mu\text{F}$, $C_{IN} = 2.2 \mu\text{F}$, S/D is tied to V_{IN} , $V_{IN} = V_O(\text{NOM}) + 1\text{V}$, $I_L = 1 \text{mA}$.

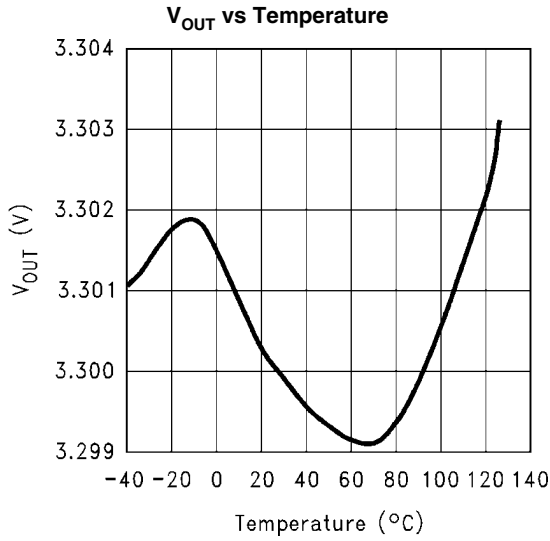

1293508

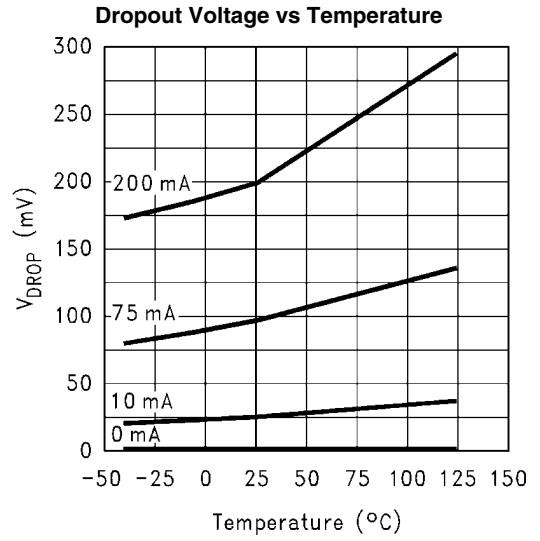

1293509

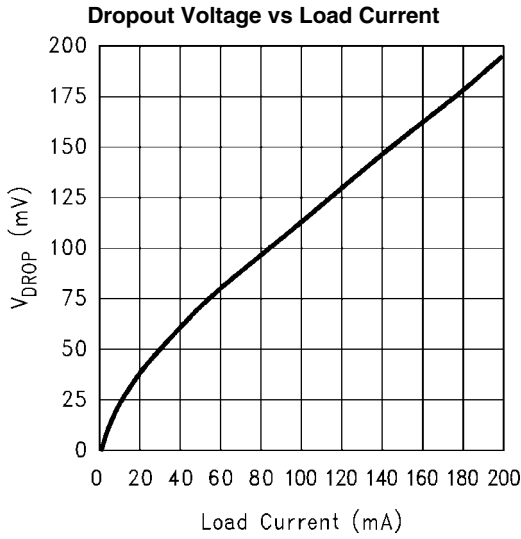

1293510

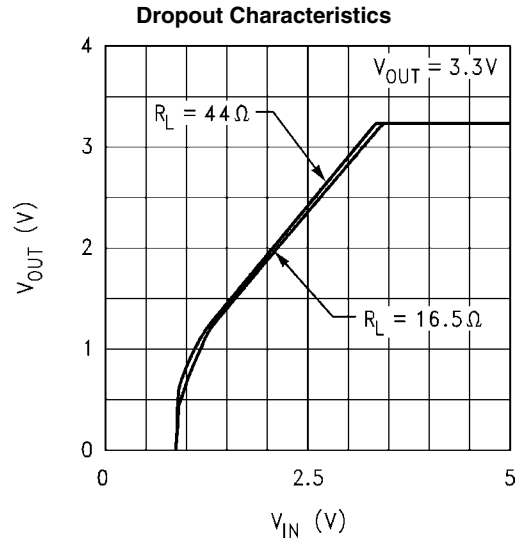

1293513

Ground Pin Current vs Temperature and Load

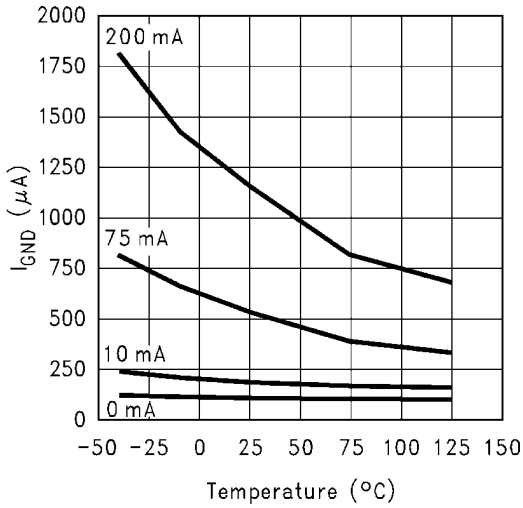

1293512

Ground Pin Current vs Load Current

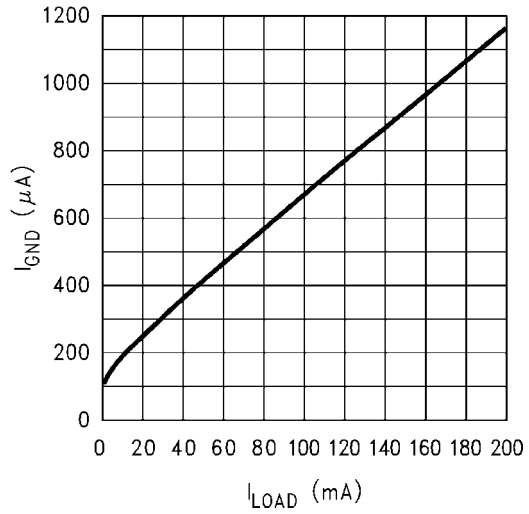

1293511

Input Current vs V_{IN}

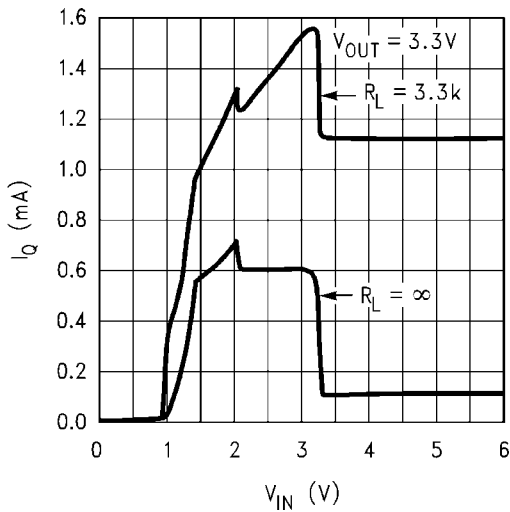

1293514

Input Current vs V_{IN}

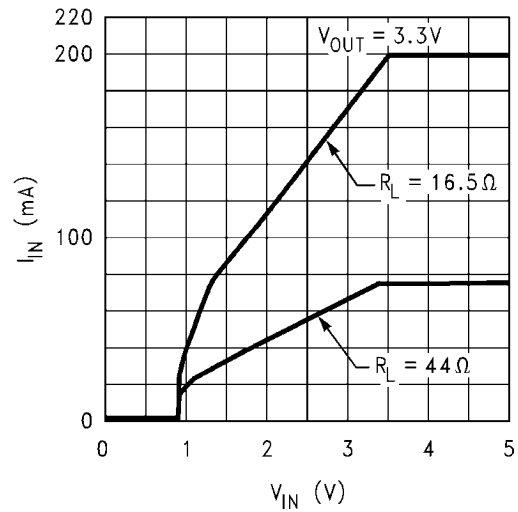

1293515

Load Transient Response

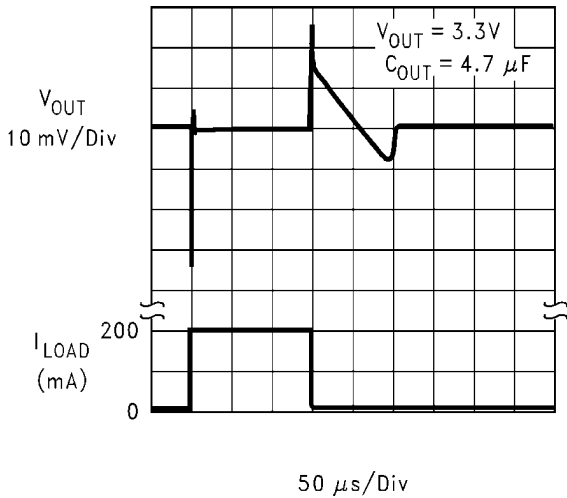

1293516

Load Transient Response

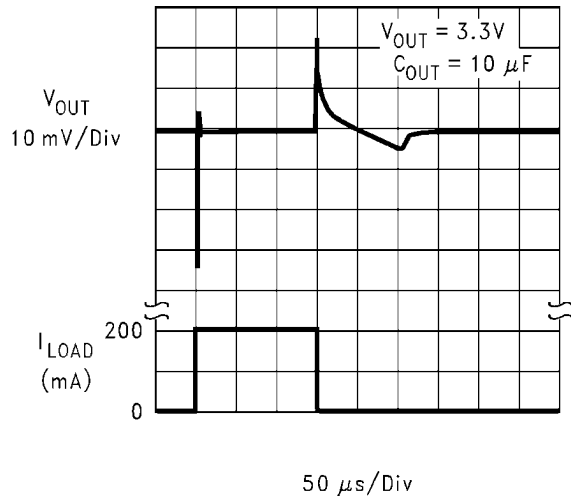

1293517

Line Transient Response

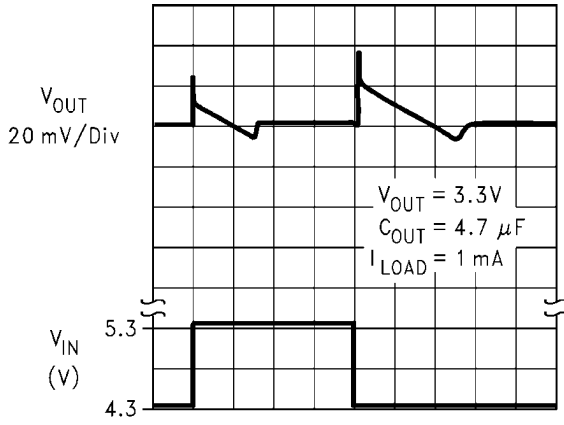

50 μs /Div

1293518

Line Transient Response

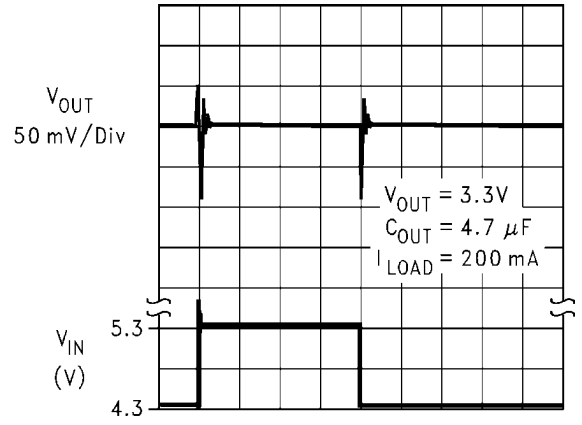

20 μs /Div

1293520

Turn-On Waveform

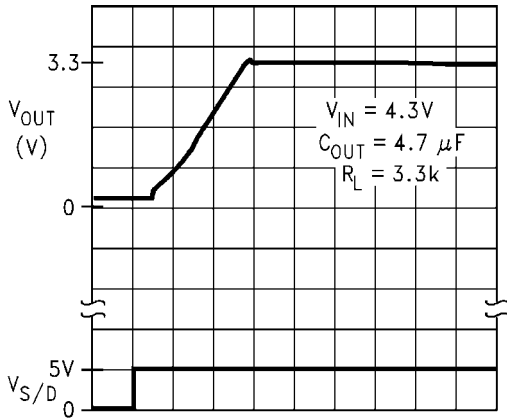

20 μs /Div

1293521

Turn-Off Waveform

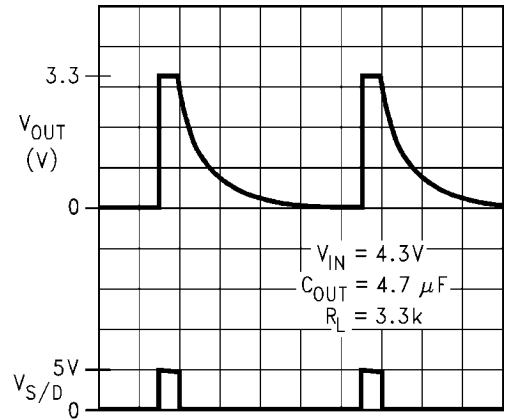

20 ms/Div

1293523

Short Circuit Current

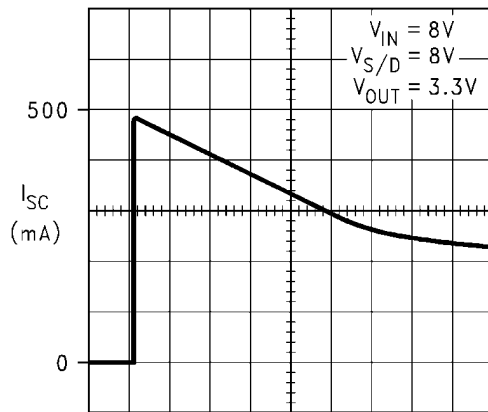

500 ms/Div

1293524

Short Circuit Current

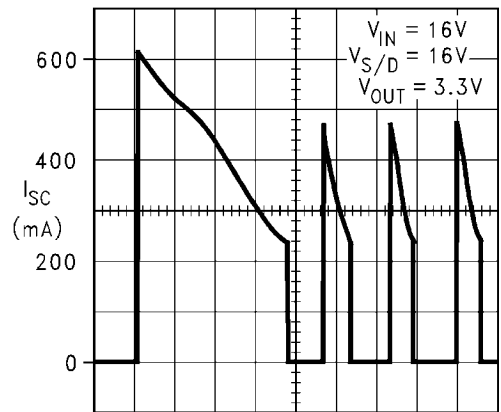

200 ms/Div

1293525

Short Circuit Current vs Output Voltage

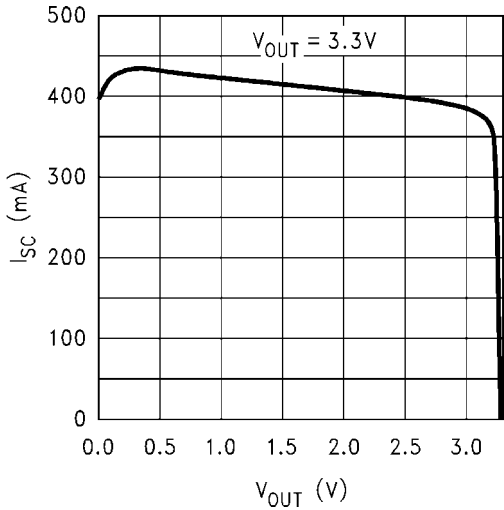

1293526

Instantaneous Short Circuit Current vs Temperature

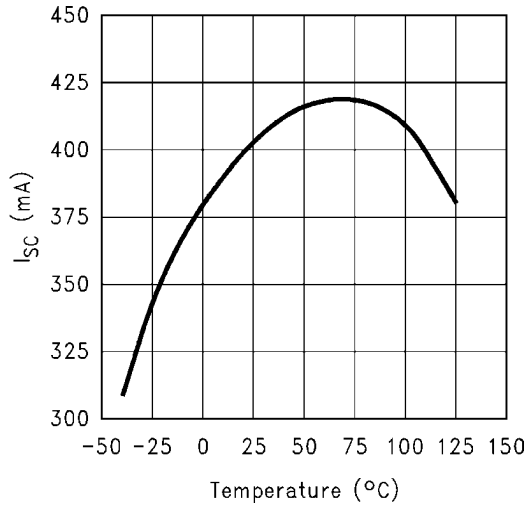

1293527

DC Load Regulation

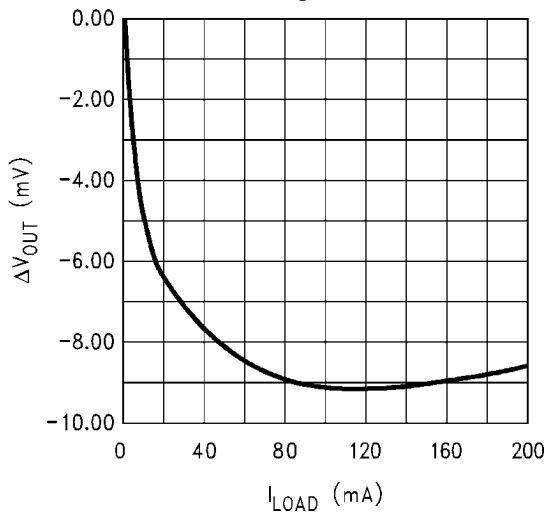

1293528

Feedback Bias Current vs Load

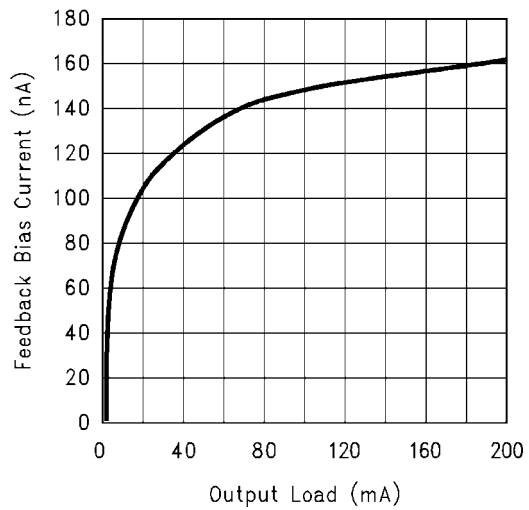

1293529

Feedback Bias Current vs Temperature

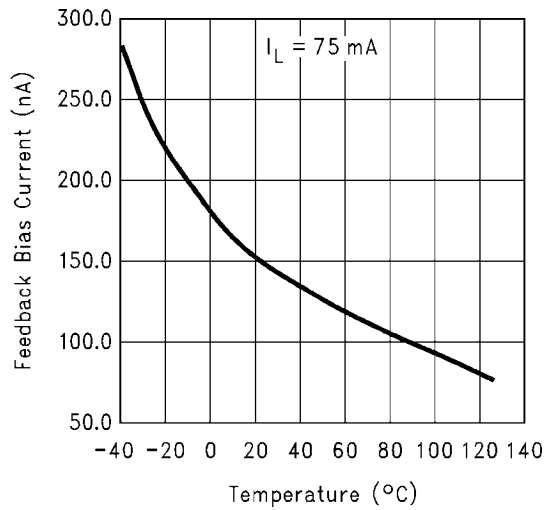

1293530

Shutdown Pin Current vs Shutdown Pin Voltage

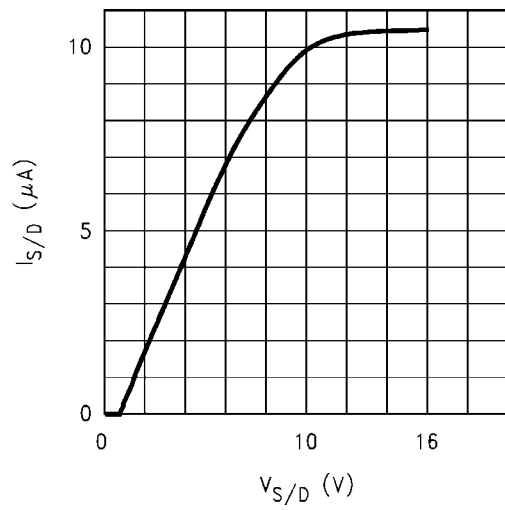

1293531

Shutdown Voltage vs Temperature

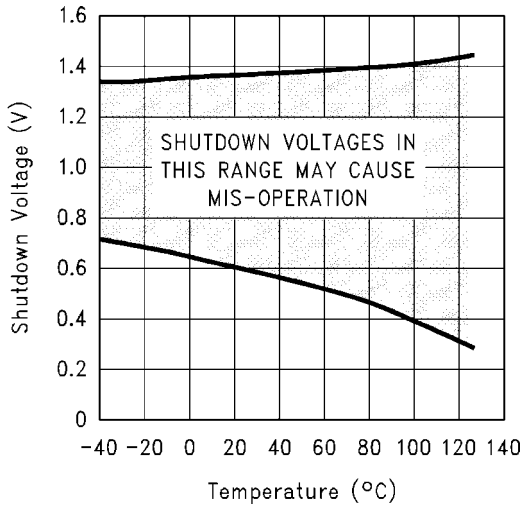

1293532

Input to Output Leakage vs Temperature

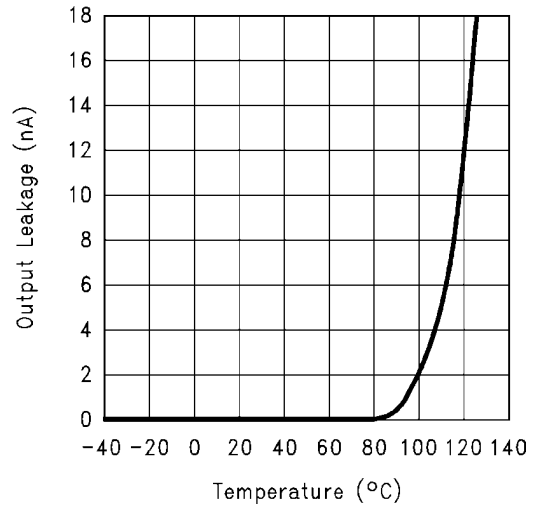

1293537

Output Noise Density

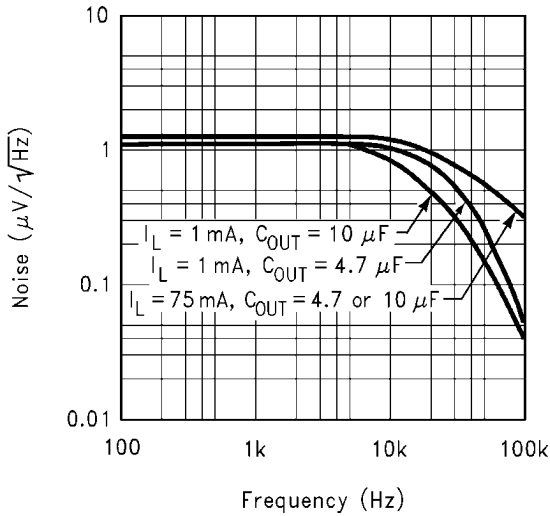

1293534

Output Impedance vs Frequency

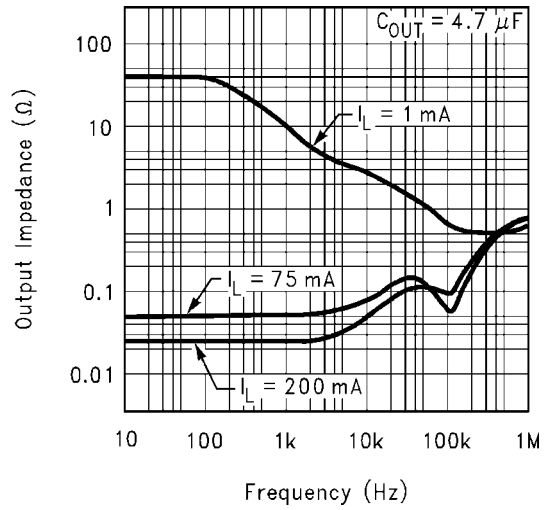

1293535

Output Impedance vs Frequency

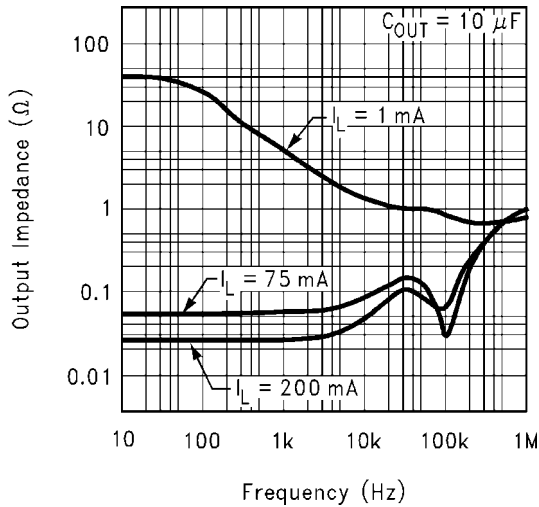

1293536

Ripple Rejection

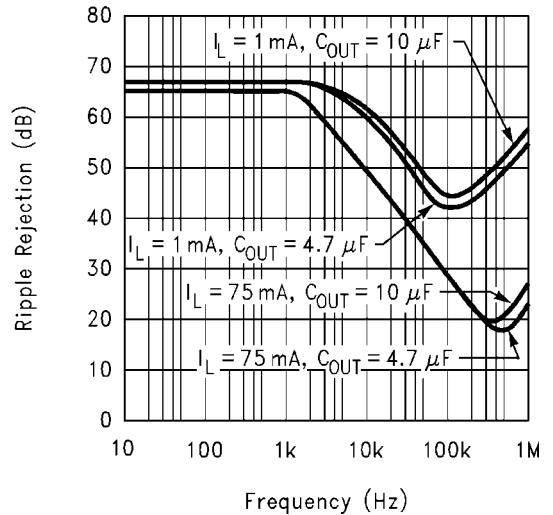

1293533

Basic Application Circuits

Application Using Internal Resistive Divider

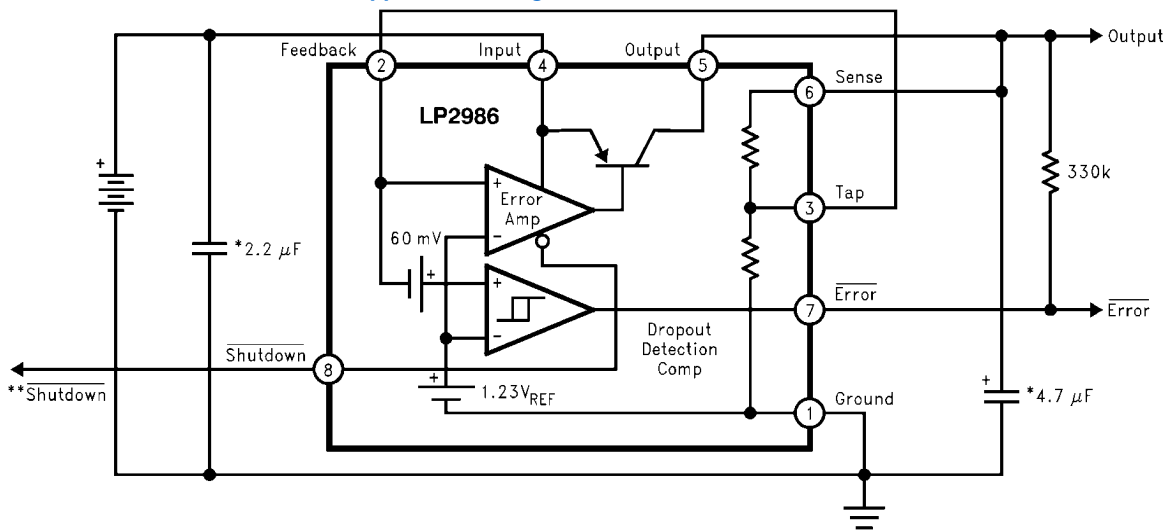

* Minimum capacitance shown to assure stability, but may be increased without limit. Larger output capacitor provides improved dynamic response.

** Shutdown input must be actively terminated. Tie to V_{IN} if not used.

1293503

Application Using External Divider

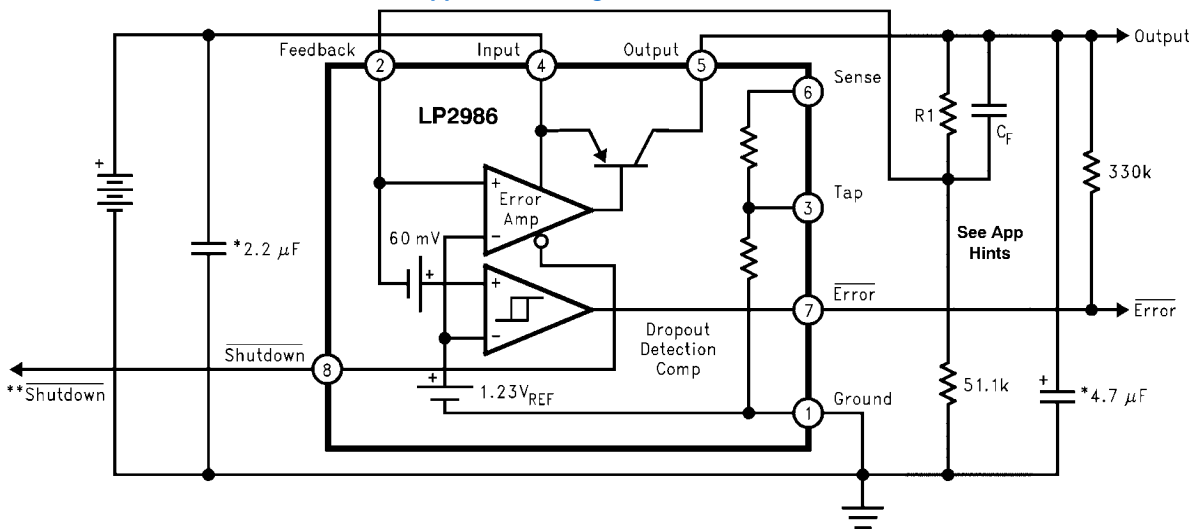

* Minimum capacitance shown to assure stability, but may be increased without limit. Larger output capacitor provides improved dynamic response.

** Shutdown input must be actively terminated. Tie to V_{IN} if not used.

1293504

Application Hints

LLP PACKAGE DEVICES

The LP2986 is offered in the 8 lead LLP surface mount package to allow for increased power dissipation compared to the SO-8 and Mini SO-8. For details on LLP thermal performance as well as mounting and soldering specifications, refer to the [LLP MOUNTING](#) section.

EXTERNAL CAPACITORS

Like any low-dropout regulator, external capacitors are required to assure stability. These capacitors must be correctly selected for proper performance.

INPUT CAPACITOR: An input capacitor ($\geq 2.2 \mu\text{F}$) is required between the LP2986 input and ground (amount of capacitance may be increased without limit).

This capacitor must be located a distance of not more than 0.5" from the input pin and returned to a clean analog ground. Any good quality ceramic or tantalum may be used for this capacitor.

OUTPUT CAPACITOR: The output capacitor must meet the requirement for minimum amount of capacitance and also have an appropriate E.S.R. (equivalent series resistance) value.

Curves are provided which show the allowable ESR range as a function of load current for various output voltages and capacitor values (see ESR curves below).

The minimum required amount of output capacitance is $4.7 \mu\text{F}$. Output capacitor size can be increased without limit.

It is important to remember that capacitor tolerance and variation with temperature must be taken into consideration when selecting an output capacitor so that the minimum required amount of output capacitance is provided over the full operating temperature range. A good Tantalum capacitor will show very little variation with temperature, but a ceramic may not be as good (see next section).

CAPACITOR CHARACTERISTICS

TANTALUM: The best choice for size, cost, and performance are solid tantalum capacitors. Available from many sources, their typical ESR is very close to the ideal value required on the output of many LDO regulators.

Tantalums also have good temperature stability: a $4.7 \mu\text{F}$ was tested and showed only a 10% decline in capacitance as the temperature was decreased from $+125^\circ\text{C}$ to -40°C . The ESR increased only about 2:1 over the same range of temperature.

However, it should be noted that the increasing ESR at lower temperatures present in all tantalums can cause oscillations when marginal quality capacitors are used (where the ESR of the capacitor is near the upper limit of the stability range at room temperature).

CERAMIC: For a given amount of a capacitance, ceramics are usually larger and more costly than tantalums.

Be warned that the ESR of a ceramic capacitor can be low enough to cause instability: a $2.2 \mu\text{F}$ ceramic was measured and found to have an ESR of about $15 \text{ m}\Omega$.

If a ceramic capacitor is to be used on the LP2986 output, a 1Ω resistor should be placed in series with the capacitor to provide a minimum ESR for the regulator.

Another disadvantage of ceramic capacitors is that their capacitance varies a lot with temperature:

Large ceramic capacitors are typically manufactured with the Z5U temperature characteristic, which results in the capacitance dropping by a 50% as the temperature goes from 25°C to 80°C .

This means you have to buy a capacitor with twice the minimum C_{OUT} to assure stable operation up to 80°C .

ALUMINUM: The large physical size of aluminum electrolytics makes them unattractive for use with the LP2986. Their ESR characteristics are also not well suited to the requirements of LDO regulators.

The ESR of an aluminum electrolytic is higher than a tantalum, and it also varies greatly with temperature.

A typical aluminum electrolytic can exhibit an ESR increase of 50X when going from 20°C to -40°C . Also, some aluminum electrolytics can not be used below -25°C because the electrolyte will freeze.

USING AN EXTERNAL RESISTIVE DIVIDER

The LP2986 output voltage can be programmed using an external resistive divider (see Basic Application Circuits).

The resistor connected between the Feedback pin and ground should be 51.1k . The value for the other resistor (R_1) connected between the Feedback pin and the regulated output is found using the formula:

$$V_{\text{OUT}} = V_{\text{FB}} \times (1 + (R_1 / 51.1\text{k}))$$

It should be noted that the $25 \mu\text{A}$ of current flowing through the external divider is approximately equal to the current

ESR Curves For 5V Output

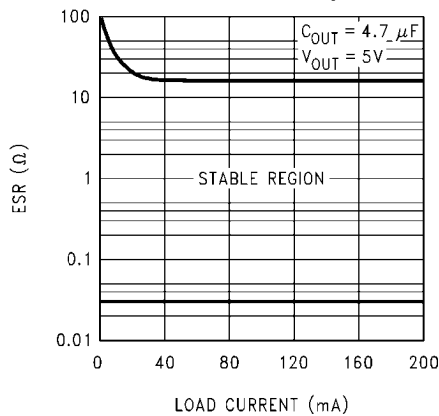

1293506

ESR Curves For 2.5V Output

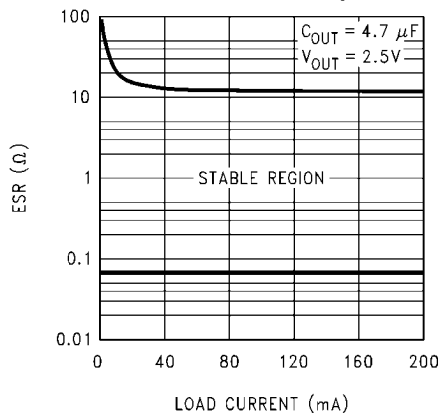

1293507

IMPORTANT: The output capacitor must maintain its ESR in the stable region over the full operating temperature range of the application to assure stability.

saved by not connecting the internal divider, which means the quiescent current is not increased by using external resistors. A lead compensation capacitor (C_F) must also be used to place a zero in the loop response at about 50 kHz. The value for C_F can be found using:

$$C_F = 1/(2\pi \times R1 \times 50k)$$

A good quality capacitor must be used for C_F to ensure that the value is accurate and does not change significantly over temperature. Mica or ceramic capacitors can be used, assuming a tolerance of $\pm 20\%$ or better is selected.

If a ceramic is used, select one with a temperature coefficient of NPO, COG, Y5P, or X7R. Capacitor types Z5U, Y5V, and Z4V can not be used because their value varies more than 50% over the -25°C to $+85^\circ\text{C}$ temperature range.

SHUTDOWN INPUT OPERATION

The LP2986 is shut off by driving the Shutdown input low, and turned on by pulling it high. If this feature is not to be used, the Shutdown input should be tied to V_{IN} to keep the regulator output on at all times.

To assure proper operation, the signal source used to drive the Shutdown input must be able to swing above and below the specified turn-on/turn-off voltage thresholds listed as V_H and V_L , respectively (see Electrical Characteristics).

Since the Shutdown input comparator does not have hysteresis, it is also important that the turn-on (and turn-off) voltage signals applied to the Shutdown input have a slew rate which is not less than $40 \text{ mV}/\mu\text{s}$ when moving between the V_H and V_L thresholds.

CAUTION: The regulator output state (either On or Off) can not be guaranteed if a slow-moving AC (or DC) signal is applied that is in the range between V_H and V_L .

LLP MOUNTING

The LDC08A (Pullback) 8-Lead LLP package requires specific mounting techniques which are detailed in National Semiconductor Application Note # 1187. Referring to the section **PCB Design Recommendations** in AN-1187 (Page 5), it should be noted that the pad style which should be used with this LLP package is the NSMD (non-solder mask defined) type. Additionally, for optimal reliability, there is a recommended 1:1 ratio between the package pad and the PCB pad for the Pullback LLP.

The thermal dissipation of the LLP package is directly related to the printed circuit board construction and the amount of additional copper area connected to the DAP.

The DAP (exposed pad) on the bottom of the LLP package is connected to the die substrate with a conductive die attach adhesive. The DAP has no direct electrical (wire) connection to any of the eight pins. There is a parasitic PN junction between the die substrate and the device ground. As such, it is strongly recommend that the DAP be connected directly to the ground at device lead 1 (i.e. GROUND). Alternately, but not recommended, the DAP may be left floating (i.e. no electrical connection). The DAP must not be connected to any potential other than ground.

For the LP2986 in the LDC08A 8-Lead LLP package, the junction-to-case thermal rating (θ_{JC}) is $7.2^\circ\text{C}/\text{W}$, where the 'case' is on the bottom of the package at the center of the DAP.

The junction-to-ambient thermal performance for the LP2986 in the LDC08A 8-Lead LLP package, using the JEDEC JESD51 standards is summarized in the following table:

Board Type	Thermal Vias	θ_{JC}	θ_{JA}
JEDEC 2-Layer JESD 51-3	None	$7.2^\circ\text{C}/\text{W}$	$184^\circ\text{C}/\text{W}$
JEDEC 4-Layer JESD 51-7	1	$7.2^\circ\text{C}/\text{W}$	$64^\circ\text{C}/\text{W}$
	2	$7.2^\circ\text{C}/\text{W}$	$55^\circ\text{C}/\text{W}$
	4	$7.2^\circ\text{C}/\text{W}$	$46^\circ\text{C}/\text{W}$
	6	$7.2^\circ\text{C}/\text{W}$	$43^\circ\text{C}/\text{W}$

REVERSE INPUT-OUTPUT VOLTAGE

The PNP power transistor used as the pass element in the LP2986 has an inherent diode connected between the regulator output and input.

During normal operation (where the input voltage is higher than the output) this diode is reverse-biased.

However, if the output voltage is pulled above the input, or the input voltage is pulled below the output, this diode will turn ON and current will flow into the regulator output pin.

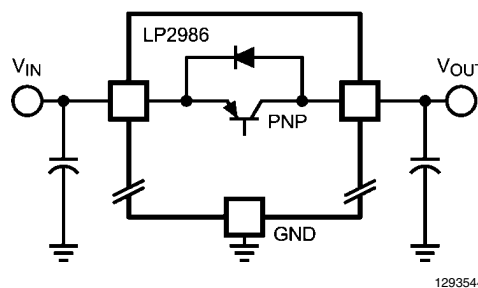

FIGURE 1. LP2986 Reverse Current Path

In such cases, a parasitic SCR can latch which will allow a high current to flow into V_{IN} (and out the ground pin), which can damage the part.

In any application where the output voltage may be higher than the input, an external Schottky diode must be connected from V_{IN} to V_{OUT} (cathode on V_{IN} , anode on V_{OUT}), to limit the reverse voltage across the LP2986 to 0.3V (see the [Absolute Maximum Ratings](#) section).

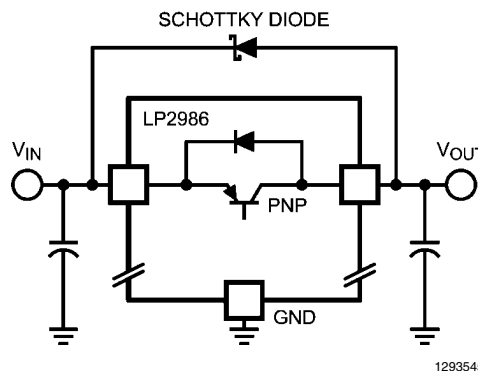
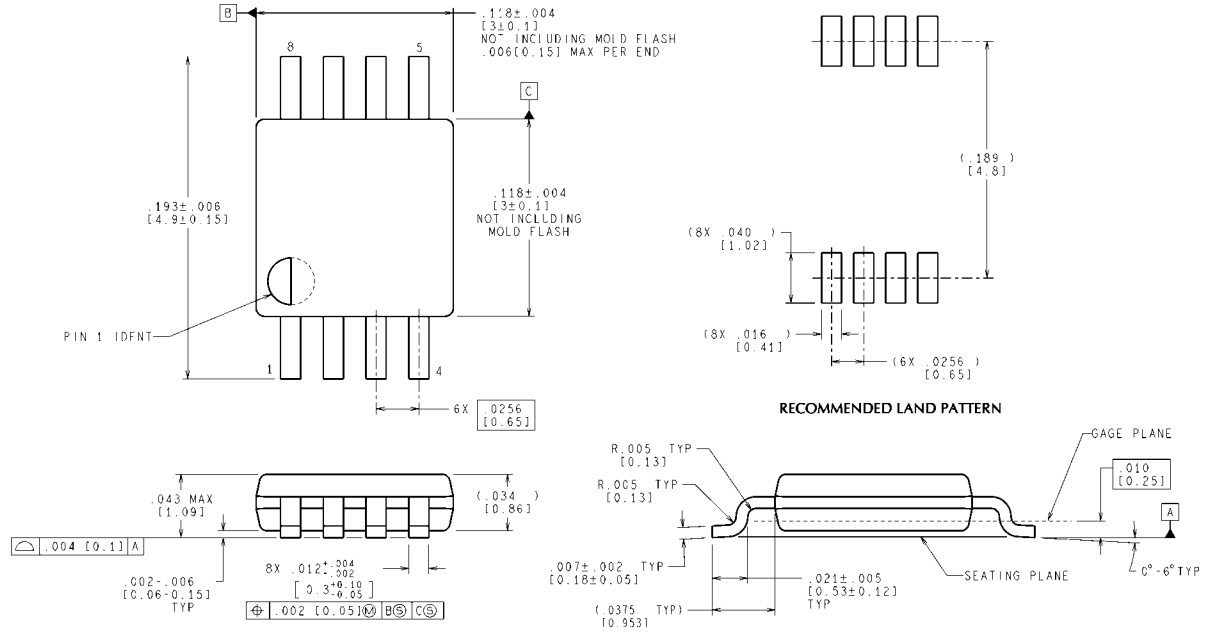

FIGURE 2. Adding External Schottky Diode Protection

Physical Dimensions inches (millimeters) unless otherwise noted



**8-Lead Mini SOIC (118 mils wide), JEDEC MO-187-AA
NS Package Number MUA08A**

MUA08A (Rev F)

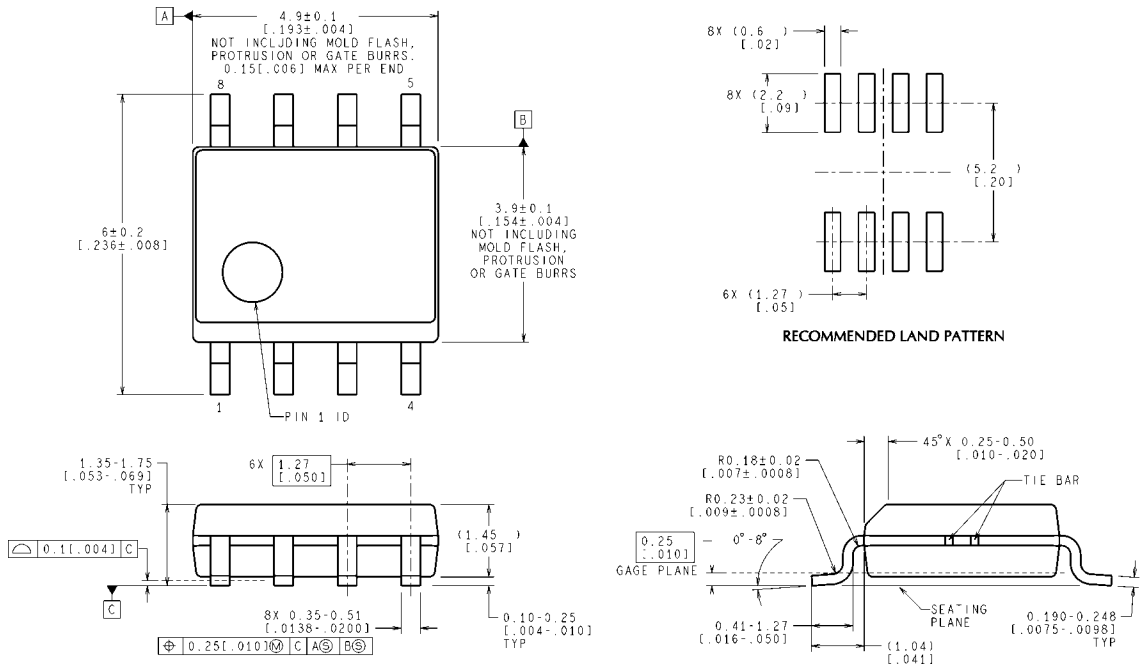

**8-Lead SOIC NARROW (154 mils wide), JEDEC MS-012-AA
NS Package Number M08A**

M08A (Rev M)

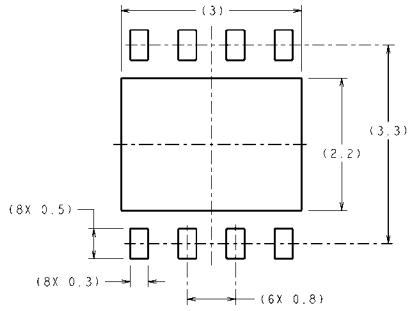

RECOMMENDED LAND PATTERN
1:1 RATION WITH PKG SOLDER PADS

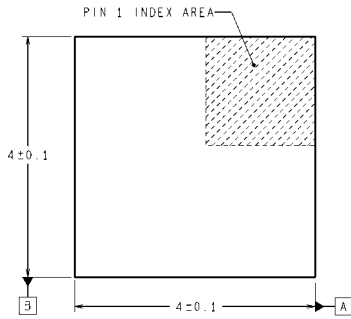

DIMENSIONS ARE IN MILLIMETERS
DIMENSIONS IN () FOR REFERENCE ONLY

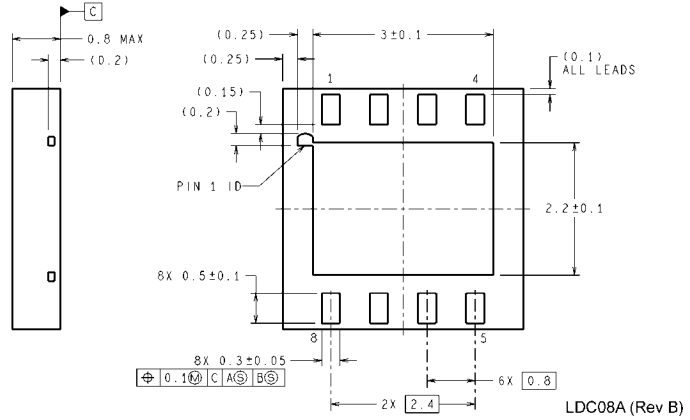

8-Lead LLP Surface Mount Package
NS Package Number LDC08A

LDC08A (Rev B)

Notes

For more National Semiconductor product information and proven design tools, visit the following Web sites at:
www.national.com

Products		Design Support	
Amplifiers	www.national.com/amplifiers	WEBENCH® Tools	www.national.com/webench
Audio	www.national.com/audio	App Notes	www.national.com/appnotes
Clock and Timing	www.national.com/timing	Reference Designs	www.national.com/refdesigns
Data Converters	www.national.com/adc	Samples	www.national.com/samples
Interface	www.national.com/interface	Eval Boards	www.national.com/evalboards
LVDS	www.national.com/lvds	Packaging	www.national.com/packaging
Power Management	www.national.com/power	Green Compliance	www.national.com/quality/green
Switching Regulators	www.national.com/switchers	Distributors	www.national.com/contacts
LDOs	www.national.com/ldo	Quality and Reliability	www.national.com/quality
LED Lighting	www.national.com/led	Feedback/Support	www.national.com/feedback
Voltage References	www.national.com/vref	Design Made Easy	www.national.com/easy
PowerWise® Solutions	www.national.com/powerwise	Applications & Markets	www.national.com/solutions
Serial Digital Interface (SDI)	www.national.com/sdi	Mil/Aero	www.national.com/milaero
Temperature Sensors	www.national.com/tempensors	SolarMagic™	www.national.com/solarmagic
PLL/VCO	www.national.com/wireless	PowerWise® Design University	www.national.com/training

THE CONTENTS OF THIS DOCUMENT ARE PROVIDED IN CONNECTION WITH NATIONAL SEMICONDUCTOR CORPORATION ("NATIONAL") PRODUCTS. NATIONAL MAKES NO REPRESENTATIONS OR WARRANTIES WITH RESPECT TO THE ACCURACY OR COMPLETENESS OF THE CONTENTS OF THIS PUBLICATION AND RESERVES THE RIGHT TO MAKE CHANGES TO SPECIFICATIONS AND PRODUCT DESCRIPTIONS AT ANY TIME WITHOUT NOTICE. NO LICENSE, WHETHER EXPRESS, IMPLIED, ARISING BY ESTOPPEL OR OTHERWISE, TO ANY INTELLECTUAL PROPERTY RIGHTS IS GRANTED BY THIS DOCUMENT.

TESTING AND OTHER QUALITY CONTROLS ARE USED TO THE EXTENT NATIONAL DEEMS NECESSARY TO SUPPORT NATIONAL'S PRODUCT WARRANTY. EXCEPT WHERE MANDATED BY GOVERNMENT REQUIREMENTS, TESTING OF ALL PARAMETERS OF EACH PRODUCT IS NOT NECESSARILY PERFORMED. NATIONAL ASSUMES NO LIABILITY FOR APPLICATIONS ASSISTANCE OR BUYER PRODUCT DESIGN. BUYERS ARE RESPONSIBLE FOR THEIR PRODUCTS AND APPLICATIONS USING NATIONAL COMPONENTS. PRIOR TO USING OR DISTRIBUTING ANY PRODUCTS THAT INCLUDE NATIONAL COMPONENTS, BUYERS SHOULD PROVIDE ADEQUATE DESIGN, TESTING AND OPERATING SAFEGUARDS.

EXCEPT AS PROVIDED IN NATIONAL'S TERMS AND CONDITIONS OF SALE FOR SUCH PRODUCTS, NATIONAL ASSUMES NO LIABILITY WHATSOEVER, AND NATIONAL DISCLAIMS ANY EXPRESS OR IMPLIED WARRANTY RELATING TO THE SALE AND/OR USE OF NATIONAL PRODUCTS INCLUDING LIABILITY OR WARRANTIES RELATING TO FITNESS FOR A PARTICULAR PURPOSE, MERCHANTABILITY, OR INFRINGEMENT OF ANY PATENT, COPYRIGHT OR OTHER INTELLECTUAL PROPERTY RIGHT.

LIFE SUPPORT POLICY

NATIONAL'S PRODUCTS ARE NOT AUTHORIZED FOR USE AS CRITICAL COMPONENTS IN LIFE SUPPORT DEVICES OR SYSTEMS WITHOUT THE EXPRESS PRIOR WRITTEN APPROVAL OF THE CHIEF EXECUTIVE OFFICER AND GENERAL COUNSEL OF NATIONAL SEMICONDUCTOR CORPORATION. As used herein:

Life support devices or systems are devices which (a) are intended for surgical implant into the body, or (b) support or sustain life and whose failure to perform when properly used in accordance with instructions for use provided in the labeling can be reasonably expected to result in a significant injury to the user. A critical component is any component in a life support device or system whose failure to perform can be reasonably expected to cause the failure of the life support device or system or to affect its safety or effectiveness.

National Semiconductor and the National Semiconductor logo are registered trademarks of National Semiconductor Corporation. All other brand or product names may be trademarks or registered trademarks of their respective holders.

Copyright© 2011 National Semiconductor Corporation

For the most current product information visit us at www.national.com



National Semiconductor Americas Technical Support Center
 Email: support@nsc.com
 Tel: 1-800-272-9959

National Semiconductor Europe Technical Support Center
 Email: europe.support@nsc.com

National Semiconductor Asia Pacific Technical Support Center
 Email: ap.support@nsc.com

National Semiconductor Japan Technical Support Center
 Email: jpn.feedback@nsc.com