

SAC3127A



GaAs MMIC Power Amplifier
27.5GHz~31GHz 36dBm

Rev1.3

Features

- Frequency: 27.5GHz~31GHz
- Gain: 27dB
- Output P_{-1dB}: 36dBm
- Supply Voltage: +6V
- Power-Added Efficiency: 25%@P_{-1dB}
- IM3 Level: -23dBc @ P_{OUT} 29 dBm/tone
-20dBc @ P_{OUT} 30 dBm/tone
- Die Size: 3.55mm×3.85mm×0.1mm
- Packaged: Bare Die

Typical Applications

- Microwave radio
- Telecommunication
- Test instrumentation
- SatCom
- VSAT
- Military and Aerospace

General Description

SAC3127A is a Ka-band GaAs MMIC power amplifier, which operates between in 27.5GHz~31GHz. SAC3127A provides 27 dB of gain, and 36dBm of output power for 1 dB compression and 25%PAE from a +6V supply.

The chip has surface passivation for protection and backside via holes and gold metallization to allow a conductive epoxy die attach process. This device is well suited for communications, Point to Point radio and radar applications.

Functional Diagram

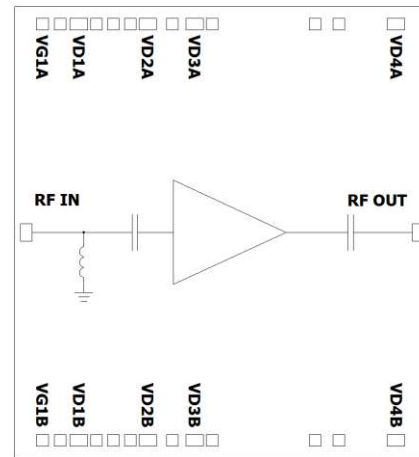

Electrical Performance

T_A=25°C, V_D=+6V, I_D=2.5A, Z₀=50Ω, CW

Parameter	Min.	Typ.	Max.	Units
Frequency Range	27.5~31			GHz
Small Signal Gain	25	27	—	dB
Small Signal Gain Flatness	—	±1	±2	dB
Reverse Isolation	—	-50	—	dB
Input VSWR	—	2	3.5	:1
Power-Added Efficiency	—	25	—	%
Output Power for 1 dB Compression (OP _{-1dB})	35	36	—	dBm
Output Third Order Intercept(OIP ₃)*	—	40	—	dBm
IM3 Level*	—	-20	—	dBc
Drain Voltage(V _D)	5	—	6	V
Gate Current(I _G)	—	5	28	mA
Supply Current(I _b)	—	3	3.7	A
Thermal Resistance	—	4.1	—	°C/W

* Measurement taken at P_{out} / Tone = 30 dBm, f_c= 30GHz, Δ f=1MHz

SuperApex, LLC

1580 S. Milwaukee Ave. Suite 405, Libertyville, IL 60048, USA
Tel: 1-847-505-8319, 1-847-573-9866
E-mail: sales@superapexco.com
Website: www.superapexco.com

Absolute Maximum Ratings

Maximum Input Power	+15dBm	Operating Temperature	-55°C~+85°C
Channel Temperature	+175°C	Storage Temperature	-65°C~+150°C
Maximum V_D	+6.5V	Maximum V_G	-2.5V

Typical Performance Curve

The results captured in the test-jig environment within connector plan

$V_D=+6V$ $I_D=2.5A$ CW

Small Signal Gain(dB) vs.Temperature

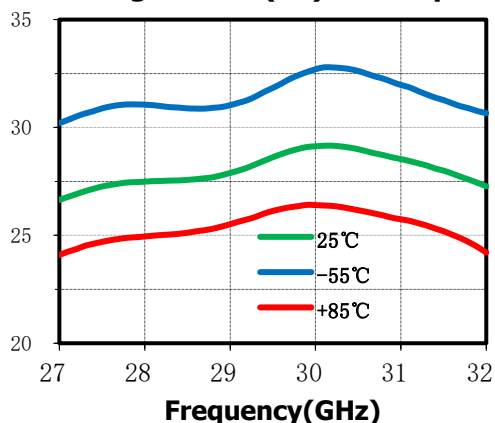

Reverse Isolation(dB)vs.Temperature

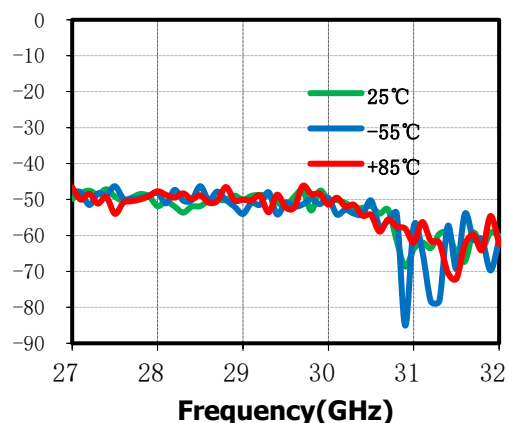

VSWRi(:1) vs.Temperature

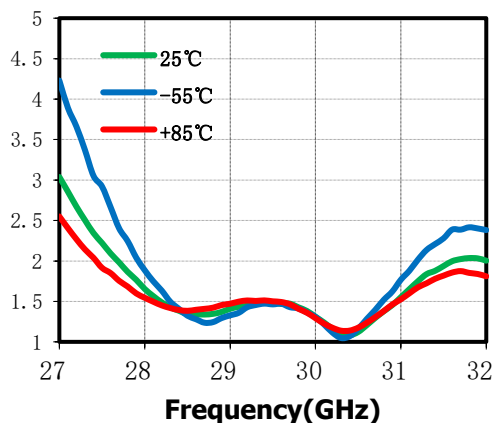

VSWRo(:1) vs.Temperature

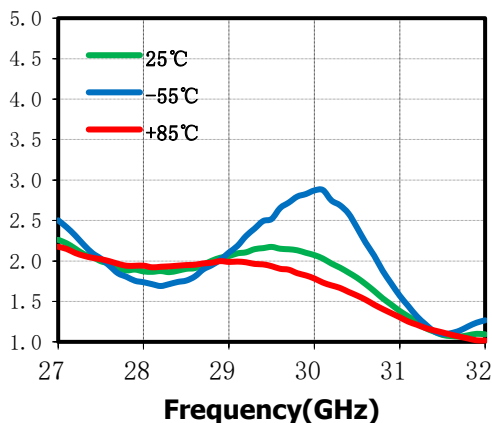

SAC3127A



GaAs MMIC Power Amplifier
27.5GHz~31GHz 36dBm

Rev1.3

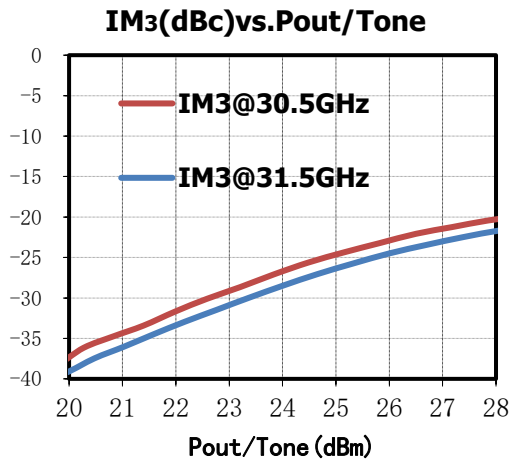
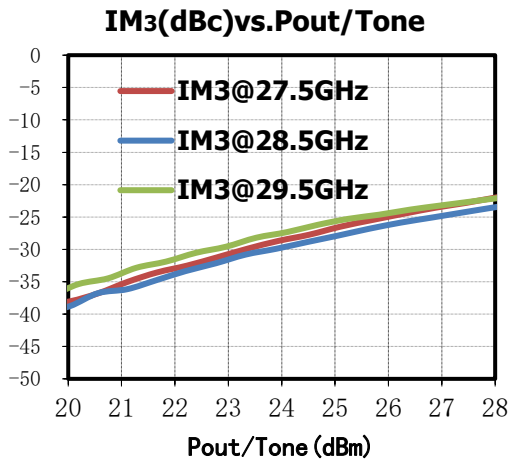

Output P-1dB(dBm)vs. Temperature

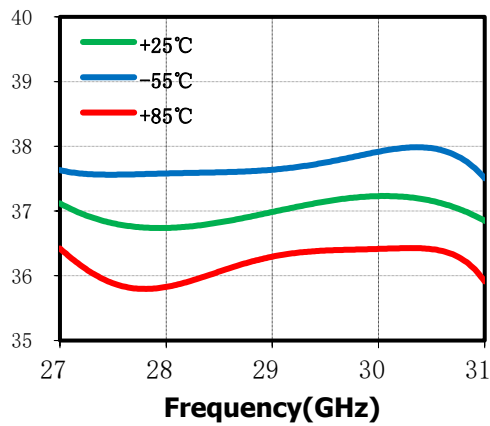

Die Outline

(All dimensions in μm)

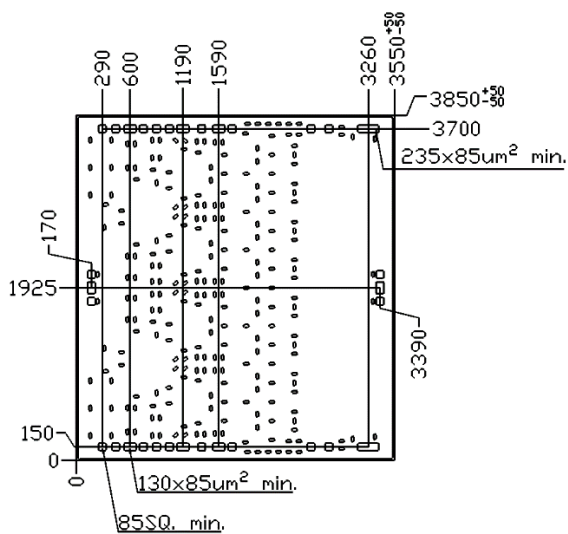

Assembly Diagram

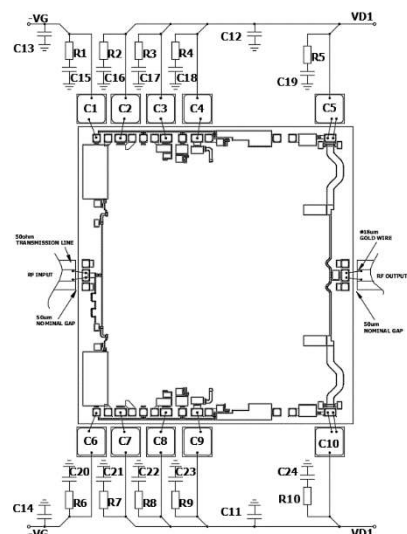

SuperApex, LLC

1580 S. Milwaukee Ave. Suite 405, Libertyville, IL 60048, USA
Tel: 1-847-505-8319, 1-847-573-9866
E-mail: sales@superapexco.com
Website: www.superapexco.com

SAC3127A



GaAs MMIC Power Amplifier
27.5GHz~31GHz 36dBm

Rev1.3

Components List

Reference Des.	Value	Part Number	Manuf.	Size
C1~C10	39pF	—	ANY	SLC
C15~C24	0.1uF	—	ANY	0603
C11~C14	10uF	—	ANY	0805
R1~R10	10Ω	—	ANY	0603

Notes

1. SAC3127A is biased with a positive drain supply and negative gate supply. The recommended gate voltage is set to -0.6~-0.9 V.
2. RF connections should be made as short as possible to reduce the inductive effect of the bond wire. Use of a 0.8 mil thermosonic wedge bonding is highly recommended as the loop height will be minimized. The RF input and output require a double bond wire as shown.
3. The backside of SAC3127A is RF ground. Eutectic mounting is preferred, If using conductive epoxy, recommended epoxies is CT2700R7S cured per the manufacturer's cure schedule. Epoxy should be applied in accordance with the manufacturers specifications and should avoid contact with the top surface of the die. An epoxy fillet should be visible around the total die periphery.
4. Bypass caps C11~C14 should be placed no farther than 5mm from the amplifier.

SuperApex, LLC

1580 S. Milwaukee Ave. Suite 405, Libertyville, IL 60048, USA
Tel: 1-847-505-8319, 1-847-573-9866
E-mail: sales@superapexco.com
Website: www.superapexco.com