



HARWIN

Component Specification

C12513

Gecko
G125 Series 1.25mm Pitch High-Rel Connectors
July 2023

SECTION	TITLE	PAGE
1	Description of Connector	2
2	Ratings	2
Appendix 1	Contact Numbering	5



1. DESCRIPTION OF CONNECTOR

Gecko connectors are 1.25mm pitch high-reliability rectangular connectors, with part numbers starting G125. There are three variants of the range; the variants are not intermateable:

- **Gecko-SL**
Screw-Lok: one connector has floating screws for secure, robust interconnection to the counterpart. Screw-Loks can also have board or panel mount studs for secure PCB or enclosure retention.
- **Gecko-MT**
Mixed Technology: connectors are equipped with both signal and power contacts and are available in cable or throughboard configurations. The same Screw-Lok fixing variations as Gecko-SL are available.
- **Gecko Latch (original design)**
Male connectors can be equipped with easy to release locking latches for secure interconnection to the female. Latches can be specified with through board locking features or surface mount pads for additional security.

The ranges generally comprise of cable barrel crimp contacts and housings available in Male and Female genders; Vertical and Horizontal Throughboard PC Tail Connectors and Vertical Surface Mount Connectors. Connectors are fully shrouded, unsealed connectors for interconnecting cable-to-cable, cable-to-board, and board-to-board applications.

The Gecko cable connectors are supplied as connector housings and separately ordered replaceable contacts. They are designed for interconnecting cable-to-cable and cable-to-board. The housings have a low profile potting wall to allow backpotting for additional strain relief and improved sealing. All ready-made cable assemblies are supplied backpotted for customer convenience, and individually pre-cabled contacts are also available.

All contacts are gold plated for high performance and long service life; the contact plating is hard acid gold of 98% purity.

The Gecko-SL and Latch ranges cover various sizes from 6 to 50 total number of contacts in a dual row configuration. Connector housings are polarised to prevent mis-mating and have contact number one indicated on the outside of the housings. Metal backshells are available that are compatible with both Gecko-SL and Gecko-MT ranges, to provide mechanical, RF and EMC protection. Gecko-MT connectors are available in a variety of signal (double row) and power (single row) contact configurations – check the website for the latest contact variations available.

2. RATINGS

2.1. Materials

All materials are listed on individual drawings.

Power Contact	Beryllium Copper, Gold over Nickel
Female Signal Contact	Beryllium Copper, Gold over Nickel
Male PCB Signal Contact.....	Phosphor Bronze, Gold over Nickel
Male Cable Signal Contact.....	Brass, Gold over Nickel
Housing	30% Glass Filled Thermoplastic, UL94 V-0
Latches.....	Copper-Nickel-Tin alloy, Tin over Nickel finish
Screw-Lok fixings.....	Stainless Steel
Metal Backshells.....	Aluminium 6061-T6, High Phosphorus Nickel finish
Potting Compound.....	Stycast 2651MM with Catalyst 9

2.2. Electrical Characteristics

2.2.1. Current Rating (EIA-364-70A: 1998)

Signal Contact:

One contact per connector is electrically loaded, 25°C ambient.....2.8A max

Current per contact through all contacts, 25°C ambient.....2.0A max

Signal Contact on Flex Circuit:

One contact per connector is electrically loaded, 25°C ambient.....0.4A max

Power Contact:

Current per contact through all contacts, 25°C ambient.....10.0A max

2.2.2. Other Electrical Characteristics

Working Voltage:

At 1,006mbar, sea level.....450V DC or AC peak

At 44mbar, 21,336m/70,000ft.....250V DC or AC peak

Voltage Proof (EIA-364-20C: 2004):

At 1,013mbar, sea level.....600V DC or AC peak

At 44mbar, 21,336m/70,000ft.....350V DC or AC peak

Contact Resistance (EIA-364-06C: 2006):

Initial20mΩ max

After conditioning25mΩ max

Insulation Resistance (EIA-364-21C: 2000):

Initial10GΩ min at 500V DC

After conditioning (excluding Salt Mist conditioning).....>1GΩ min at 500V DC

Creepage Distance (contact-to-contact)0.15mm min

Clearance Distance (contact-to-contact).....0.15mm min

2.3. Environmental Characteristics

Humidity (EIA-364-31B: 2000) 65/150/56 days at 93% RH

Temperature Range (EIA-364-32C: 2000 Test Cond. IV)..... 30mins dwell, 5 cycles at -65°C to +150°C

Temperature Life (EIA-364-17B: 1999 Test Cond. X Method A) .. +150°C±5°C without load

Salt Mist (EIA-364-26B: 1999 Test Condition B) 48 hours continuous exposure

Vibration Severity ◇● (EIA-364-28D: 1999 Test Cond. IV) 10Hz to 2,000Hz, 1.5mm, 198m/s² (20G),
2 hour duration

Shock Severity ◇❖● (EIA-364-27B: 1996 Test Cond. E)..... 981m/s² (100G) for 6ms in Z axis,
490m/s² (50G) for 11ms in X & Y axes

Bump Severity ◇ 390m/s² (40G), 4,000±10 Bumps

Acceleration Severity (EIA-364-01A: 2000)..... 490m/s² (50G)

◇ Latches or Screw-Loks fully utilized.

❖ X & Y tested at lower levels due to shaker limitations.

● It is recommended that back-potting compound is applied to crimp assemblies for vibration at higher frequencies.

2.4. Mechanical Characteristics

Durability (contacts)	1,000 operations
Durability (latches)	100 operations
<i>By hand or with Z125-926XX00 tools; minimum added retention of 20N.</i>	
Insertion Force (per contact, using mating contact):	
Signal	2.8N max
Power	7.0N max
Withdrawal Force (per contact, using mating contact)	0.2N min
Contact Retention in Housing (all contact types)	6.0N min
Screw-Lok Retention in Housing	20.0N min
Latch Retention in Housing	4.0N min
Screw-Lok Torque	16 to 18cmN

2.5. Wire Termination Information

2.5.1. Signal Contacts

Wire Type (recommended)	BS 3G 210 type A, MIL-W-16878/6 type ET or NEMA HP3 type ET
Maximum Insulation Diameter	Ø0.84mm
Insulation Strip Length	1.50-1.75mm
Recommended Tooling	Hand Crimp Tool Z125-900 Positioner Z125-901 Insertion/Removal Tool Z125-902
Recommended potting compound	Stycast 2651MM with Catalyst 9

AWG Wire Size	Qty & Nominal diameter (mm) of strands	Conductor Diameter (mm)	Area (mm ²)	Circular MIL Area (CMA)	Crimp Tool Setting	Crimp Height (mm)	Minimum Pull-Off Force (N)
26	7/0.15	0.533	0.128	253	6	0.95-1.10	18
28	7/0.13	0.381	0.072	159	5		13
30	7/0.10	0.305	0.057	100	5		12
32	7/0.08	0.203	0.035	62	5		6

For information on crimping Gecko signal contacts refer to [Tooling Instruction Sheet IS-37](#). For information on insertion/removal of Gecko signal cable contacts refer to [Tooling Instruction Sheet IS-38](#). There is also a Video on crimping and inserting Gecko contacts: harwin.com/harwintv.

2.5.2. Power Contacts

Wire Type (recommended)	M22759/11-18 PTFE (MIL-W-22759/11)
Maximum Insulation Diameter	Ø1.35mm
Insulation Strip Length	1.90-2.30mm
Recommended Hand Crimp Tooling	Hand Crimp Tool Z125-903 Positioner Z125-904 Insertion/Removal Tool Z125-905
Recommended potting compound	Stycast 2651MM with Catalyst 9

AWG Wire Size	Qty & Nominal diameter (mm) of strands	Conductor Diameter (mm)	Area (mm ²)	Circular MIL Area (CMA)	Crimp Tool Setting	Minimum Pull-Off Force (N)
18	19/0.25	1.250	0.930	1624	8	85

For information on crimping Gecko-MT power contacts refer to [Tooling Instruction Sheet IS-44](#). For information on insertion/removal of Gecko power contacts refer to [Tooling Instruction Sheet IS-47](#). There is also a Video on crimping and inserting Gecko contacts: harwin.com/harwintv.

APPENDIX 1 – CONTACT NUMBERING

A1.1. Gecko-SL

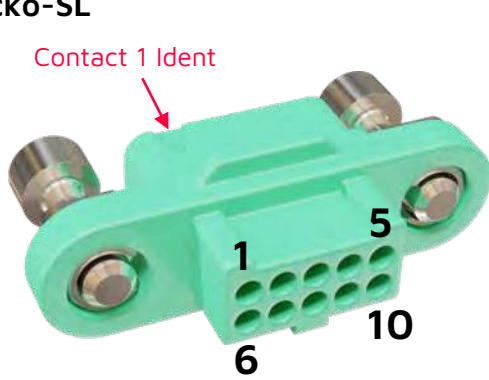

Female Crimp Housing

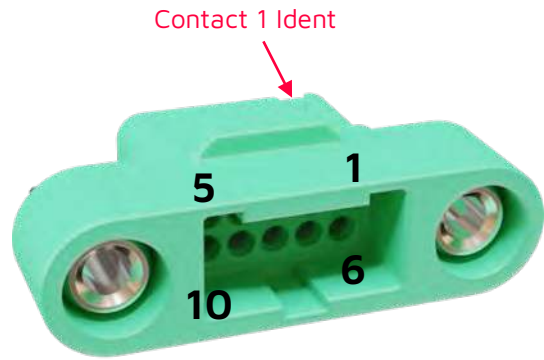

Male Crimp Housing

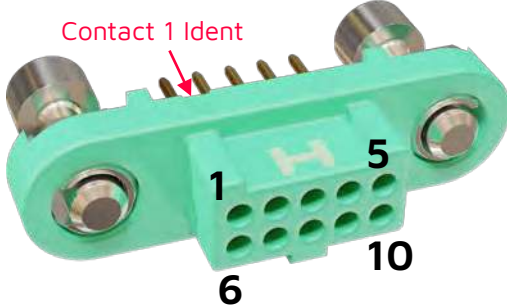

Female PCB mounted

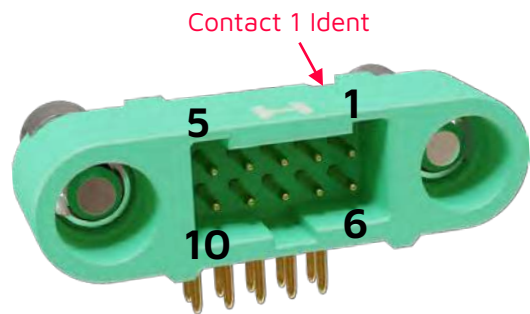

Male PCB mounted

A1.2. Gecko Latch

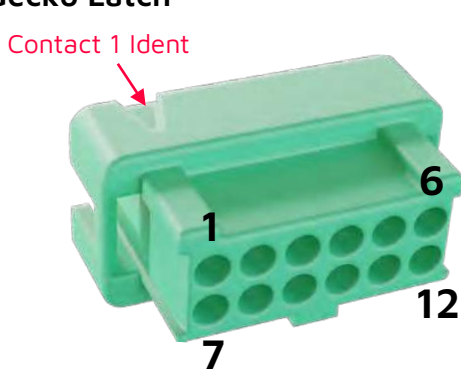

Female Crimp Housing

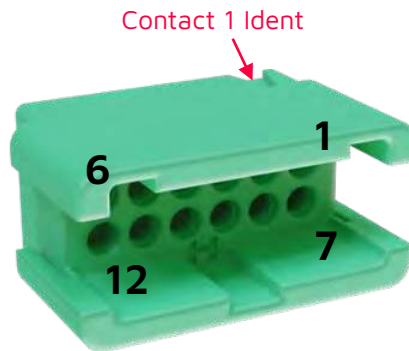

Male Crimp Housing

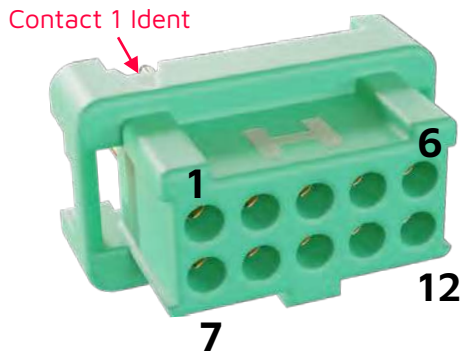

Female PCB mounted

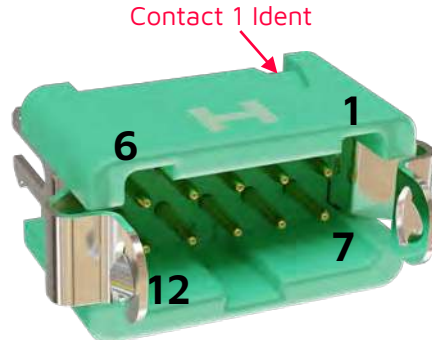

Male PCB mounted

A1.3. Gecko-MT (non-standard layout)

The following variants adhere to this convention where special contacts are both sides of the signal contacts only:

- G125-22496FX-0X-08-0X - Female Crimp Housing
- G125-32496MX-0X-08-0X - Male Crimp Housing
- G125-FV1XXFX-XABXABP - Female PCB Mounted
- G125-MH1XXMX-XADXADP - Male PCB Mounted

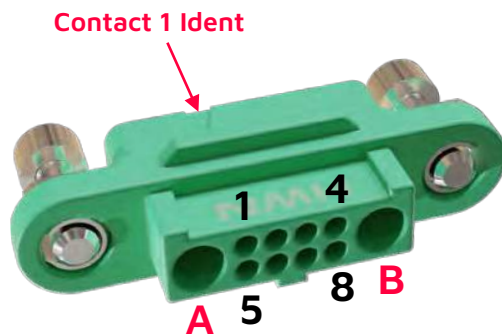

Female Crimp Housing

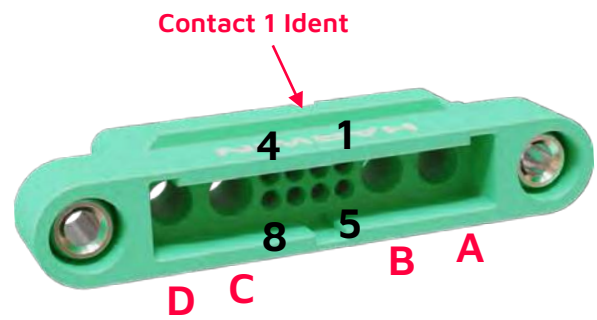

Male Crimp Housing

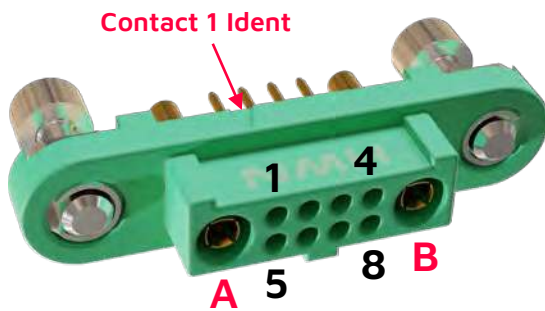

Female PCB mounted

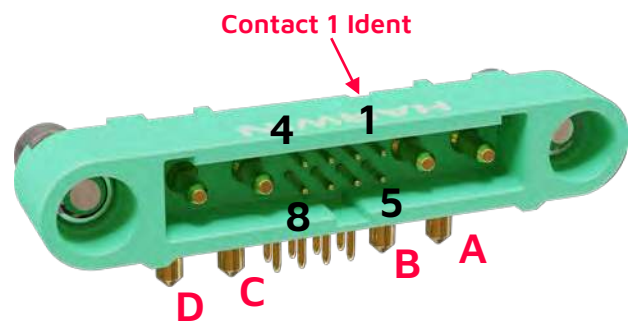

Male PCB mounted

A1.3. Gecko-MT (standard layout)

Variants shown have 8 signal contacts and 3 power contacts. This convention is true for the following part numbers where special contacts are on one side of the signal contacts only:

- G125-22496FX-XX-XX-00 - Female Crimp Housing
- G125-32496MX-XX-XX-00 - Male Crimp Housing
- G125-FV1XXFX-XXAB000P - Female PCB Mounted
- G125-MH1XXMX-XXAD000P - Male PCB Mounted

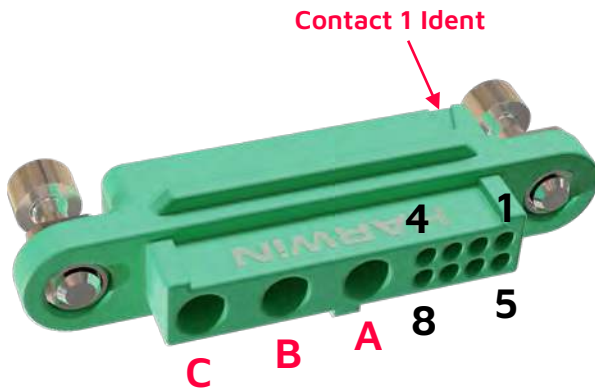

Female Crimp Housing

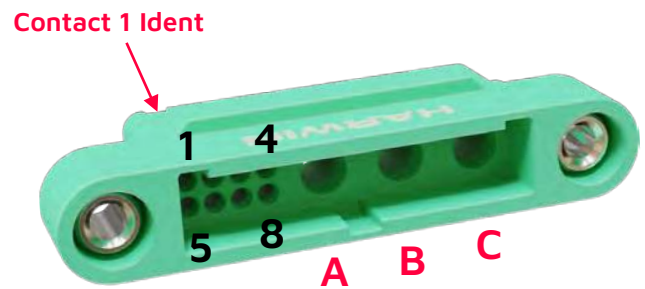

Male Crimp Housing

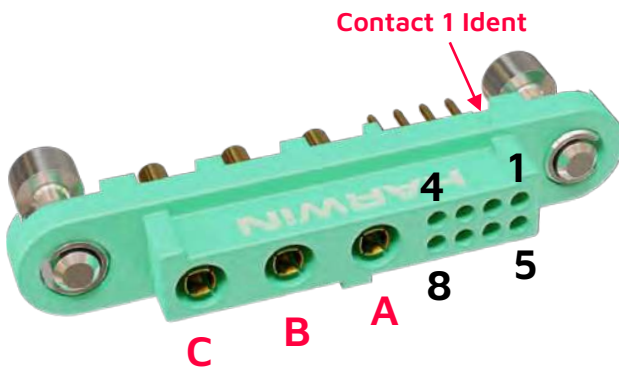

Female PCB mounted

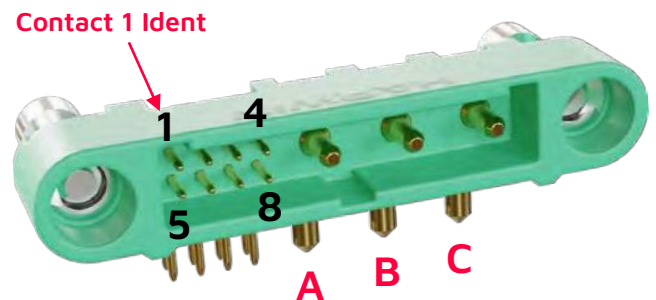

Male PCB mounted