

YLTG Series

1000Base-T Magnetics modules-To support 1:1 Turns Ratio Transceivers

TRIGON
COMPONENTS



Mechanical Dimensions

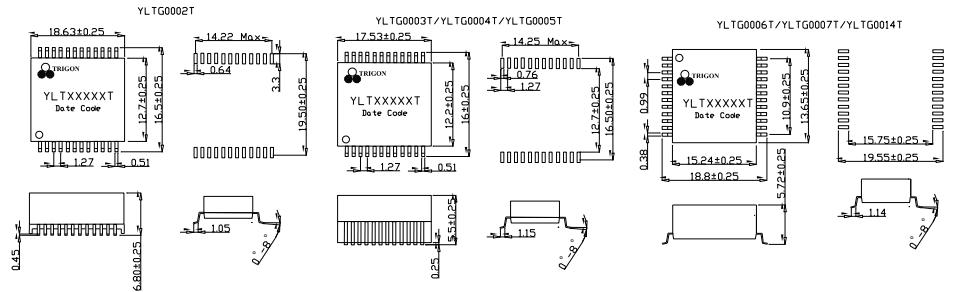

FEATURES

- Surface Mount
- Cost Effective
- Optimum Performance
- Industrial Standard Foot Print
- Optional Pin-Outs
- RoHS peak reflow temperature rating 245°C.
- Meets IEEE 802.3 specification.

ORDERING CODE

YLT G XXXX T

(1) (2) (3) (4)

- (1) LAN Transformer
- (2) Gigabit
- (3) Series code
- (4) Package
T= Tape & Reel

YLTG0001T/YLTG0008T/YLTG0009T/YLTG0010T

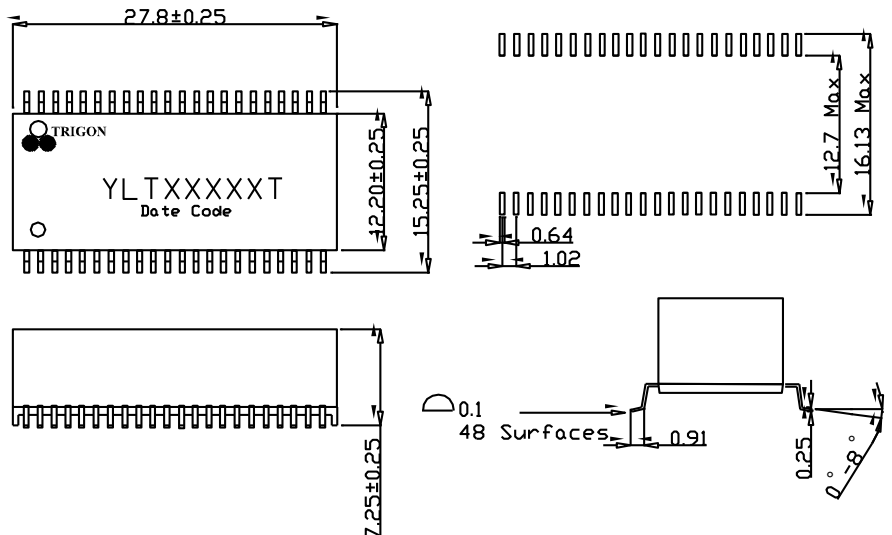

YLTG Series

1000 Base-T Magnetics modules-To support 1:1 Turns Ratio Transceivers

TRIGON
COMPONENTS

Electrical Specifications @ 25°C, Operating Temperature 0°C~70°C

Part Number	Number of Ports	Insertion Loss (dB TYP)	Return Loss (dB Min)				
			1-100MHZ	1-30MHZ	40MHZ	50MHZ	60-80 MHZ
YLTG0001T	2	1.4	-16	-14.4	-13.1	-12	-10
YLTG0002T	1	1.1	-18	-18	-13.6	-12	-
YLTG0003T	1	1	-18	-18	-16	-12	-10
YLTG0004T	1	1	-18	-18	-16	-12	-10
YLTG0005T	1	1	-18	-18	-16	-12	-10
YLTG0006T	1	1	-18	-18	-16	-12	-10
YLTG0007T	1	1	-18	w-18	-16	-12	-10
YLTG0008T	1	1	-18	-18	-16	-12	-10
YLTG0009T	2	1.4	-16	-14.4	-13.1	-12	-10
YLTG0010T	2	1.4	-16	-14.4	-13.1	-12	-10
YLTG0011T	1	1	-18	-18	-16	-12	-10
YLTG0012T	2	1	-18	-14.4	-13.1	-12	-10
YLTG0013T	2	1	-18	-14.4	-13.1	-12	-10
YLTG0014T	2	1.4	-16	-14.4	-13.1	-12	-10

Electrical Specifications (Continued)

Part Number	Crosstalk (dB TYP)			Differential to Common Mode Rejection (dB TYP)			Hipot (Vrms MIN)
	30MHZ	60MHZ	100MHZ	30MHZ	60MHZ	100MHZ	
YLTG0001T	-43.5	-37.5	-33	-45	-40	-35	1500
YLTG0002T	-35	-31.5	-27	-30	-30	-30	1500
YLTG0003T	-43	-37	-33	-43	-37	-33	1500
YLTG0004T	-43	-37	-33	-43	-37	-33	1500
YLTG0005T	-43	-37	-33	-43	-37	-33	1500
YLTG0006T	-43	-37	-33	-43	-37	-33	1500
YLTG0007T	-43	-37	-33	-43	-37	-33	1500
YLTG0008T	-43	-37	-33	-43	-37	-33	1500
YLTG0009T	-43.5	-37.5	-33	-45	-40	-35	1500
YLTG0010T	-43.5	-37.5	-33	-45	-40	-35	1500
YLTG0011T	-43	-37	-33	-43	-37	-33	1500
YLTG0012T	-40	-37	-28	-40	-35	-30	1500
YLTG0013T	-40	-37	-28	-40	-35	-30	1500
YLTG0014T	-43.5	-37.5	-33	-45	-40	-33	1500

- OCL: 350uH min. with 8mA applied.
- Transformers with operating temperature @ -40°C ~ +85°C are available upon request.
- YLTG0013T already have operating temperature @ -40°C ~ +85°C

YLTG Series

1000 Base-T Magnetics modules-To support 1:1 Turns Ratio Transceivers

TRIGON
COMPONENTS

Schematics

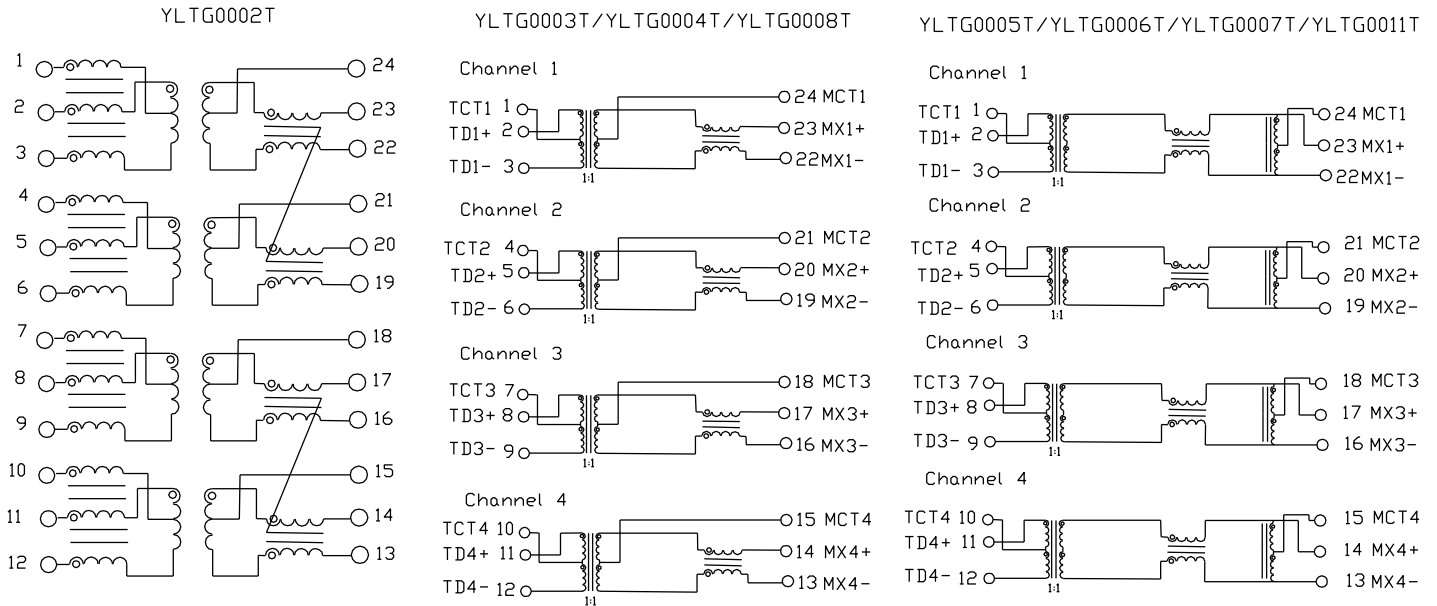

YLTG Series

1000 Base-T Magnetics modules-To support 1:1 Turns Ratio Transceivers

TRIGON
COMPONENTS

YLTG0001T/YLTG0010T

Channel 1-Port 1

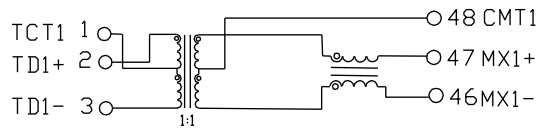

Channel1-Port2

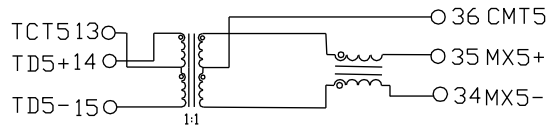

Channel2-Port1

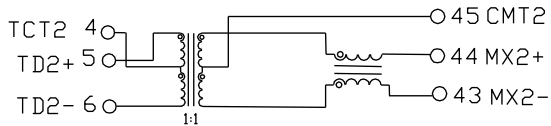

Channel 2-Port 2

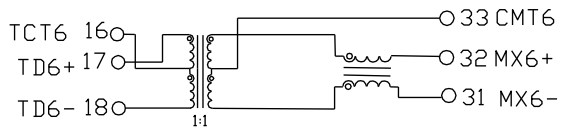

Channel 3-Port 1

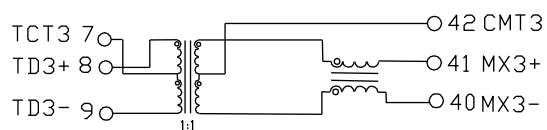

Channel 3-Port 2

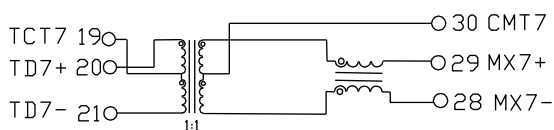

Channel 4-Port 1

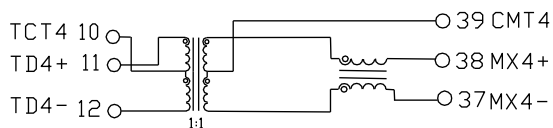

Channel 4-Port 2

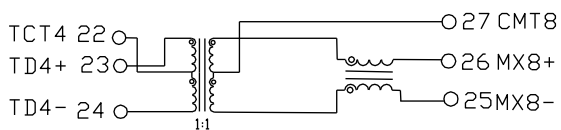

YLTG0012T/YLTG0013T

Channel 1-Port 1

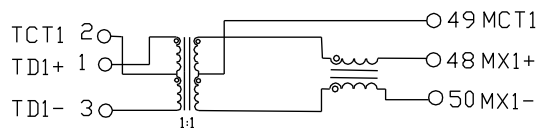

Channel 1-Port 1

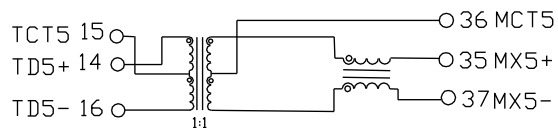

Channel 2-Port 1

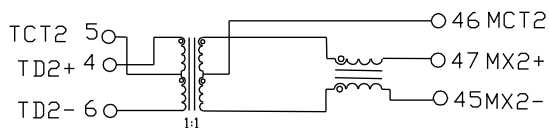

Channel 2-Port 1

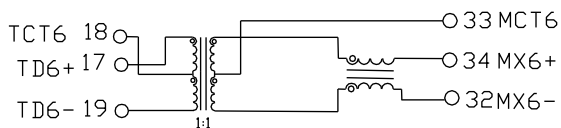

Channel 3-Port 1

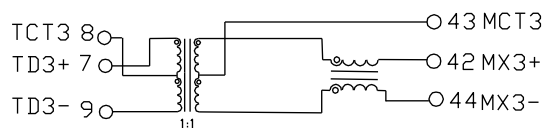

Channel 3-Port 1

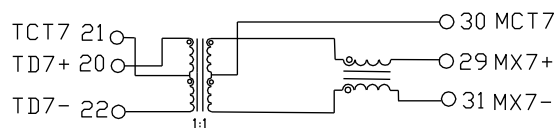

Channel 4-Port 1

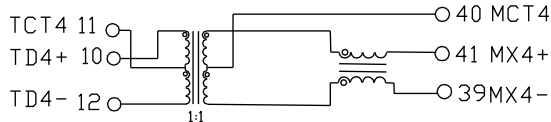

Channel 4-Port 1

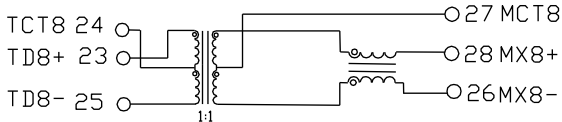

YLTG Series

1000 Base-T Magnetics modules-To support 1:1 Turns Ratio Transceivers

TRIGON
COMPONENTS

Contact Information



USA OFFICE

Add: 939 Mariner Street Brea, CA 92821 U.S.A
Tel: +1-714-990-1367
Fax: +1-714-990-1459
Email: sales@trigoncomponents.com

TAIWAN OFFICE

Add: 5F, No.37, Lane 221 Gang Qian Road, Nei-Hu Taipei, Code 114, Taiwan
Tel: +886-2-2657-6216
Fax: +886-2-2657-5296
Email: salesTW@trigoncomponents.com

SHANGHAI OFFICE

Add: Rm 1710, No. 1258, Yu Yuan Road, Chang Ning District, Shanghai, 200050, China
Tel: +86-21-52372201~03
Fax: +86-21-52372205
Email: salesSH@trigoncomponents.com

HONGKONG OFFICE

Add: Rm. 802, 8/F., Shun Kwong Commercial Building, No. 8 Des Voeux Road West, Sheung Wan, Hong Kong
Tel: +852-2975-9084~5
Fax: +852-2975-9086
Email: salesHK@trigoncomponents.com

CHINA MANUFACTURING PLANT

Add: No.551, Ju Jin Road, Zhangpu, Kunshan, China
Tel: +86-512-5517-3688
Fax: +86-512-5517-3788

BRASIL SALES REP OFFICE

Add: Calçada das Palmas, 20 – sala 01 – 1 andar Centro Comercial de Alphaville CEP 06453-041 – Barueri – São Paulo – Brasil
Tel: +55-11-4688-1960
Fax: +55-11-4191-6758

KOREA SALES REP OFFICE

Add: 445-160 1F 129-5 Bansong-Dong Hwaseong-Si Gyeonggi-Do Korea
Tel: +82-31-8015-3477

FRANCE SALES REP OFFICE

Add: 19 Rue Vivienne, Paris, France
Tel: +33-6-0715-5528