

TERMINALS ARE TO BE ORIENTED AND LOADED
IN TO THE HOUSING AS SHOWN ABOVE

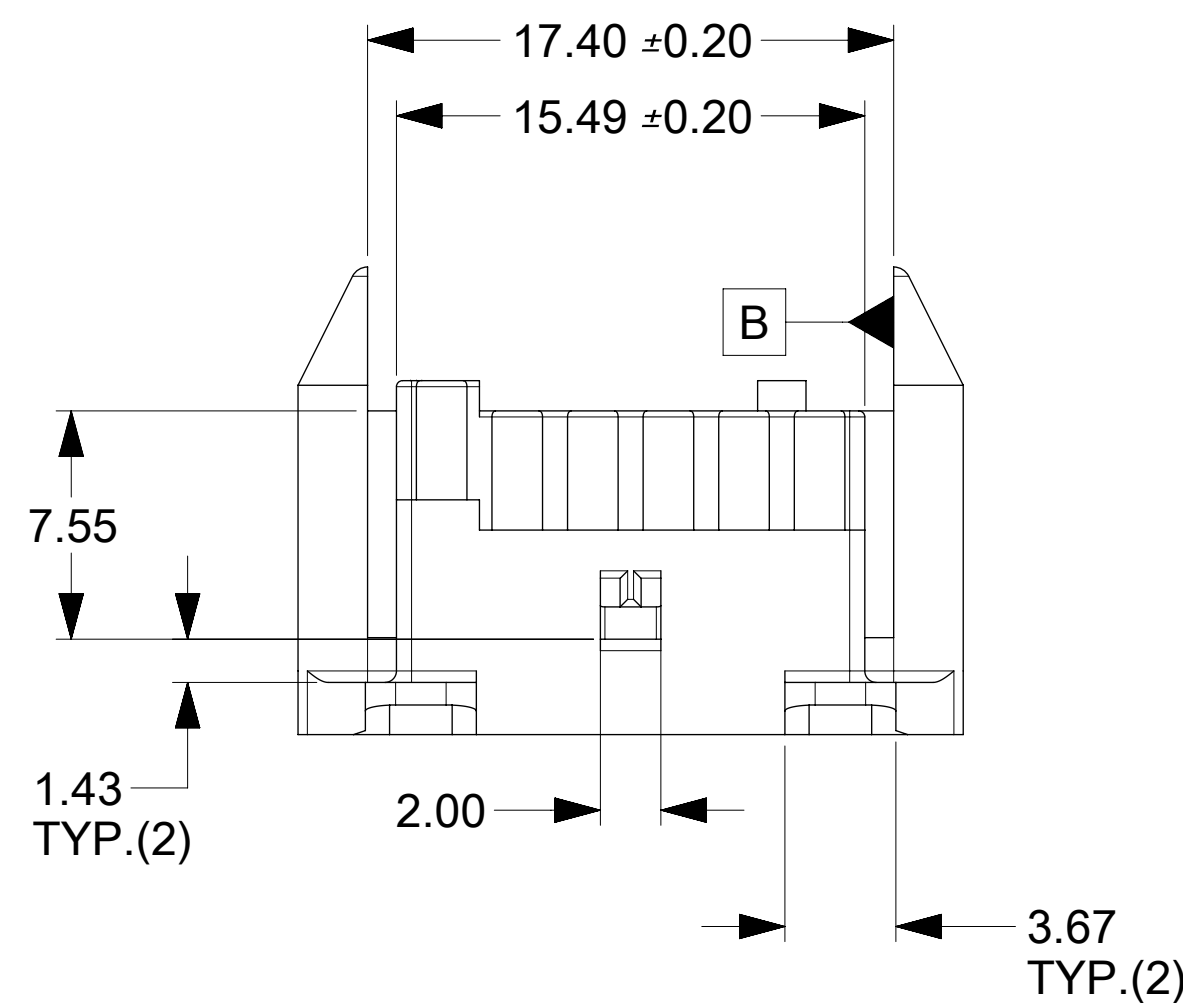
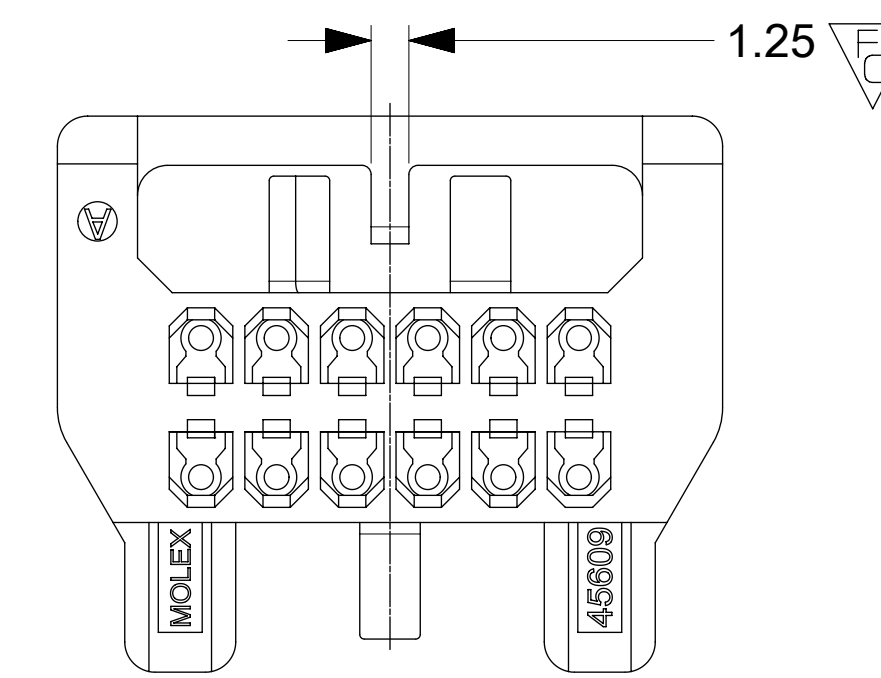
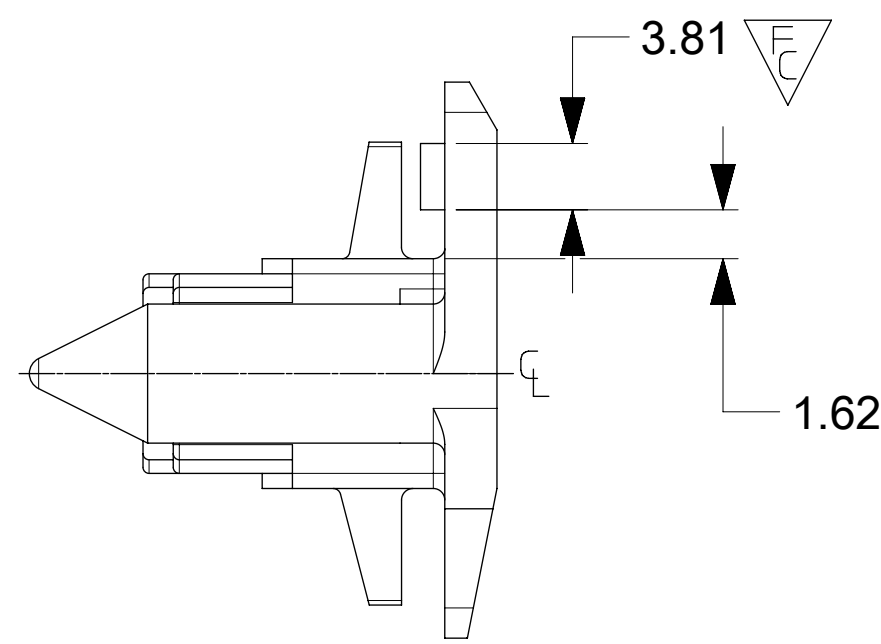
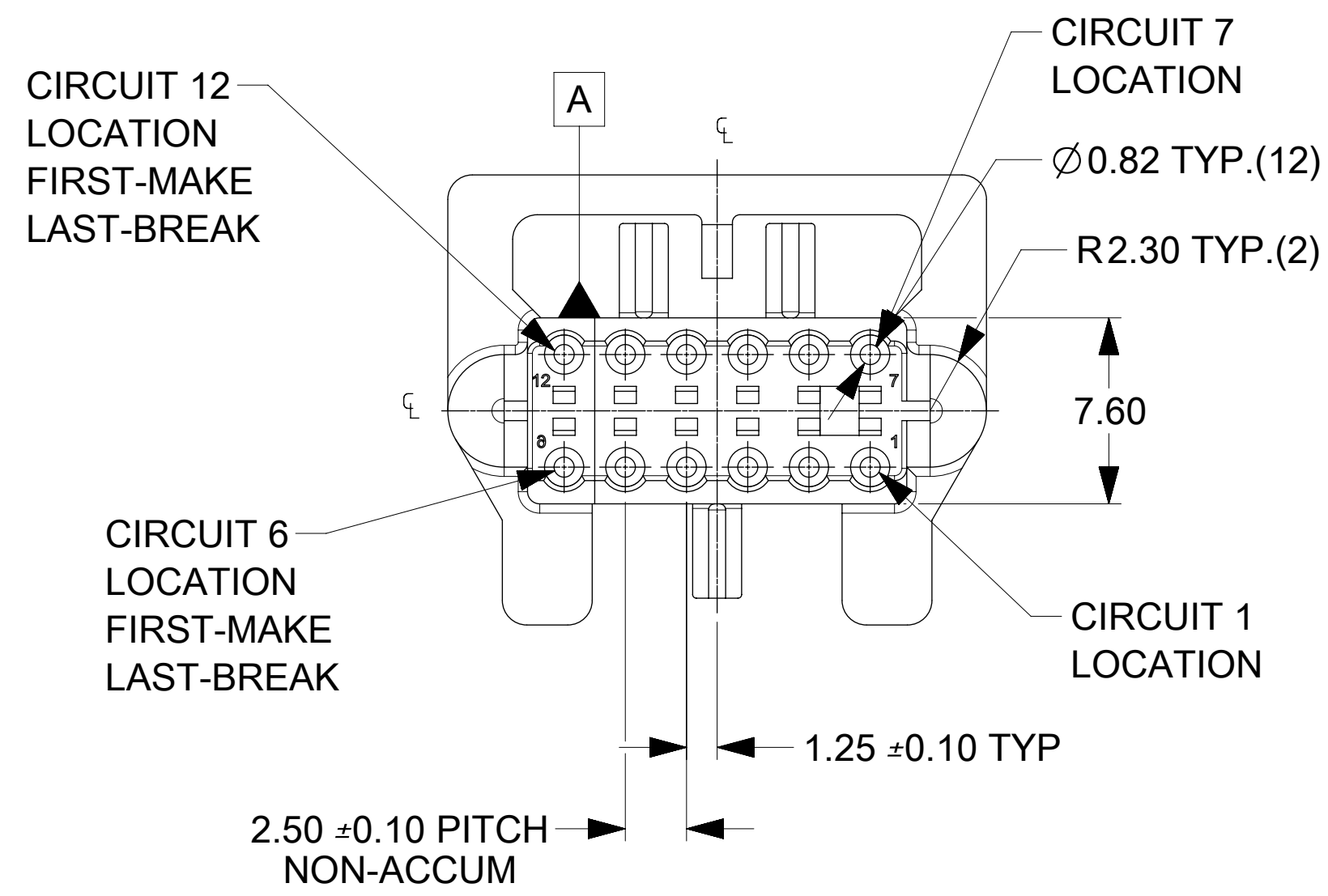

NOTES:

1. MATERIAL: POLYESTER, UL94V-0, COLOR: BLACK.
2. PRODUCT SPECIFICATION: TBD.
3. USES FEMALE CRIMP TERMINALS, SERIES 5263. (NOTE ORIENTATION OF TERMINALS)
4. PART MATES WITH MOLEX HEADER ASSEMBLY SERIES 45608.
5. PACKAGING: BULK.
6. SEE PAGE 2 OF 2 FOR PANEL CUTOUT DIMENSIONS AND THE ALLOWED BOARD TO PANEL MISALIGNMENT.
7. USE TOOL NUMBER 63813-1400 TO REMOVE TERMINALS FROM HOUSING WHEN NECESSARY. CAUTION: TERMINALS MUST NOT BE REUSED AFTER REMOVAL.

THIS DRAWING CONTAINS INFORMATION THAT IS PROPRIETARY TO MOLEX ELECTRONIC TECHNOLOGIES, LLC AND SHOULD NOT BE USED WITHOUT WRITTEN PERMISSION									
DIMENSION UNITS		SCALE		CURRENT REV DESC:					
MM		4:1		<p>molex</p> <p>SPOX BMI RECEPTACLE HOUSING, 12 PIN PANEL MOUNT</p> <p>PRODUCT CUSTOMER DRAWING</p> <p>DOCUMENT NUMBER: SD-45609-012 DOC TYPE: PSD DOC PART: 001 REVISION: A5</p> <p>EC NO: 625546 DRWN: RLALSANGI 2017/09/11</p> <p>CHK'D: ISHWARG 2019/10/18</p> <p>APPR: ISHWARG 2019/10/18</p> <p>INITIAL REVISION:</p> <p>DRWN: DROSCA 2006/09/06</p> <p>APPR: JCOMERCI 2006/09/06</p> <p>DRAFT WHERE APPLICABLE MUST REMAIN WITHIN DIMENSIONS</p> <p>THIRD ANGLE PROJECTION</p> <p>DRAWING: D-SIZE SERIES: 45609</p> <p>MATERIAL NUMBER: 45609-0012 CUSTOMER: IBM</p> <p>SHEET NUMBER: 1 OF 2</p>					
GENERAL TOLERANCES (UNLESS SPECIFIED)									
	MM	INCH							
4 PLACES	±	±							
3 PLACES	±	±							
2 PLACES	± 0.25	±							
1 PLACE	± 0.3	±							
0 PLACES	±	±							
ANGULAR TOL		± 0.5 °							

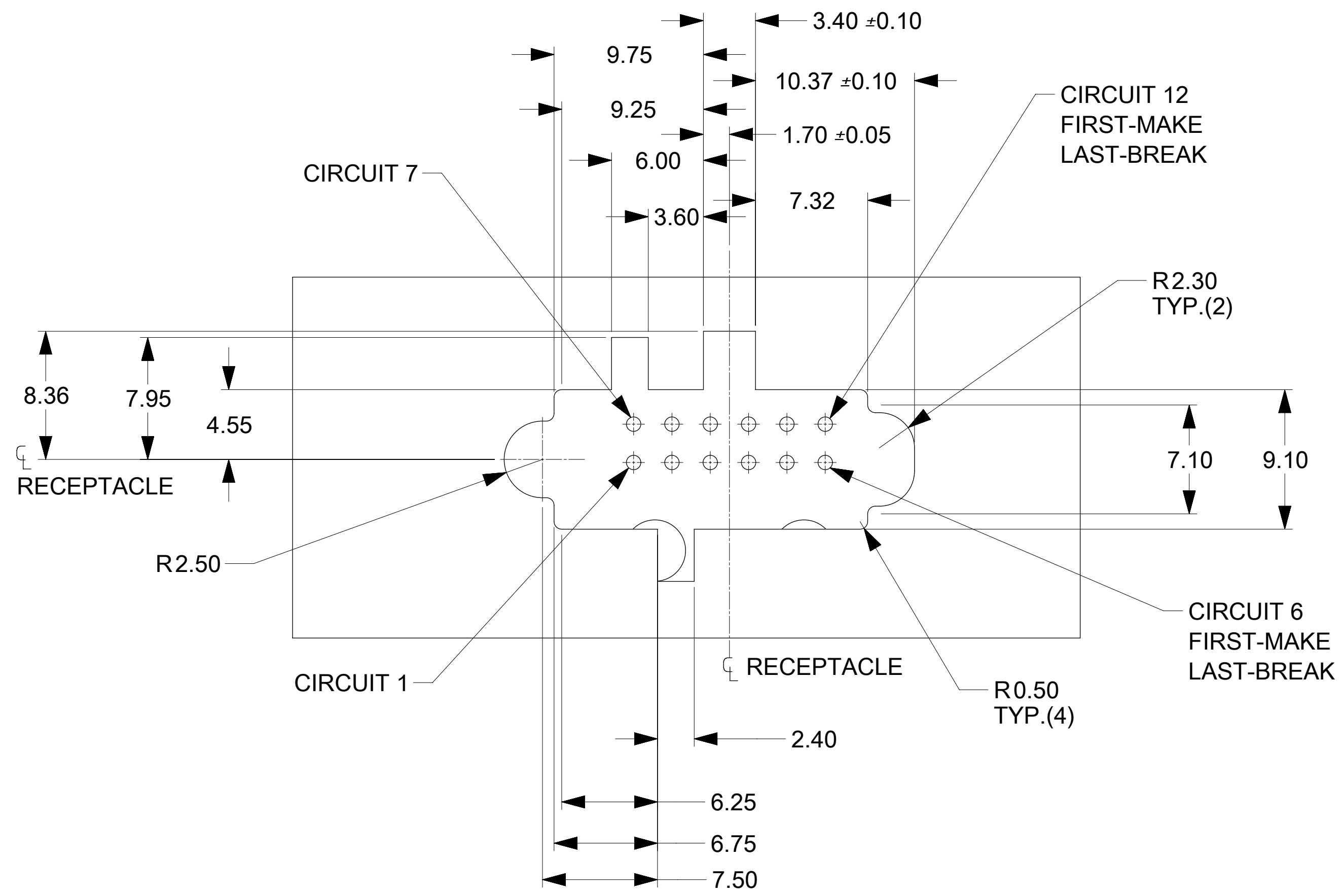

PANEL CUTOUT
PANEL THICKNESS 1.20±0.12MM

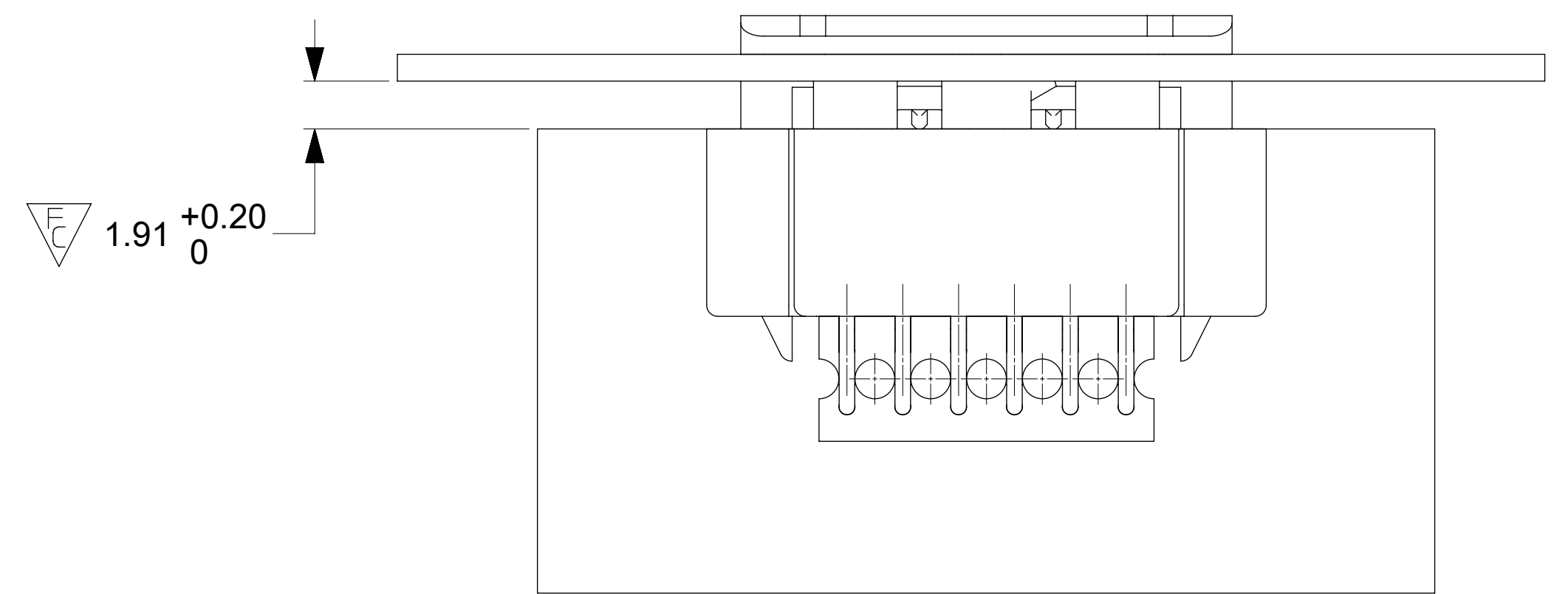
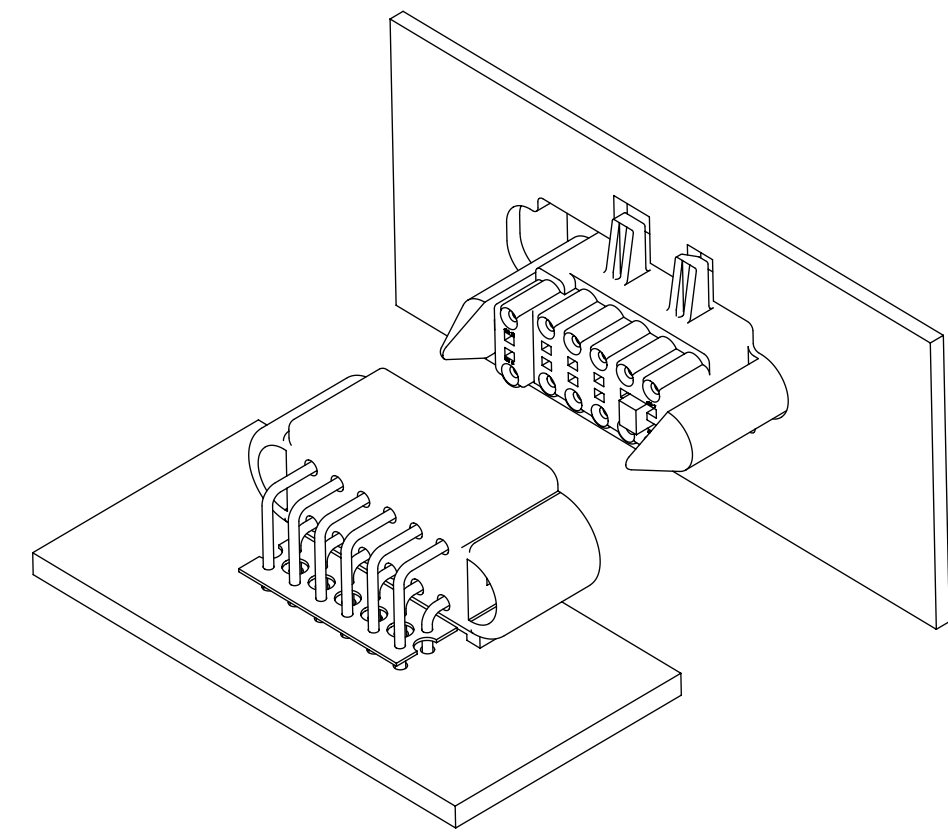

PANEL TO PCB STACK HEIGHT

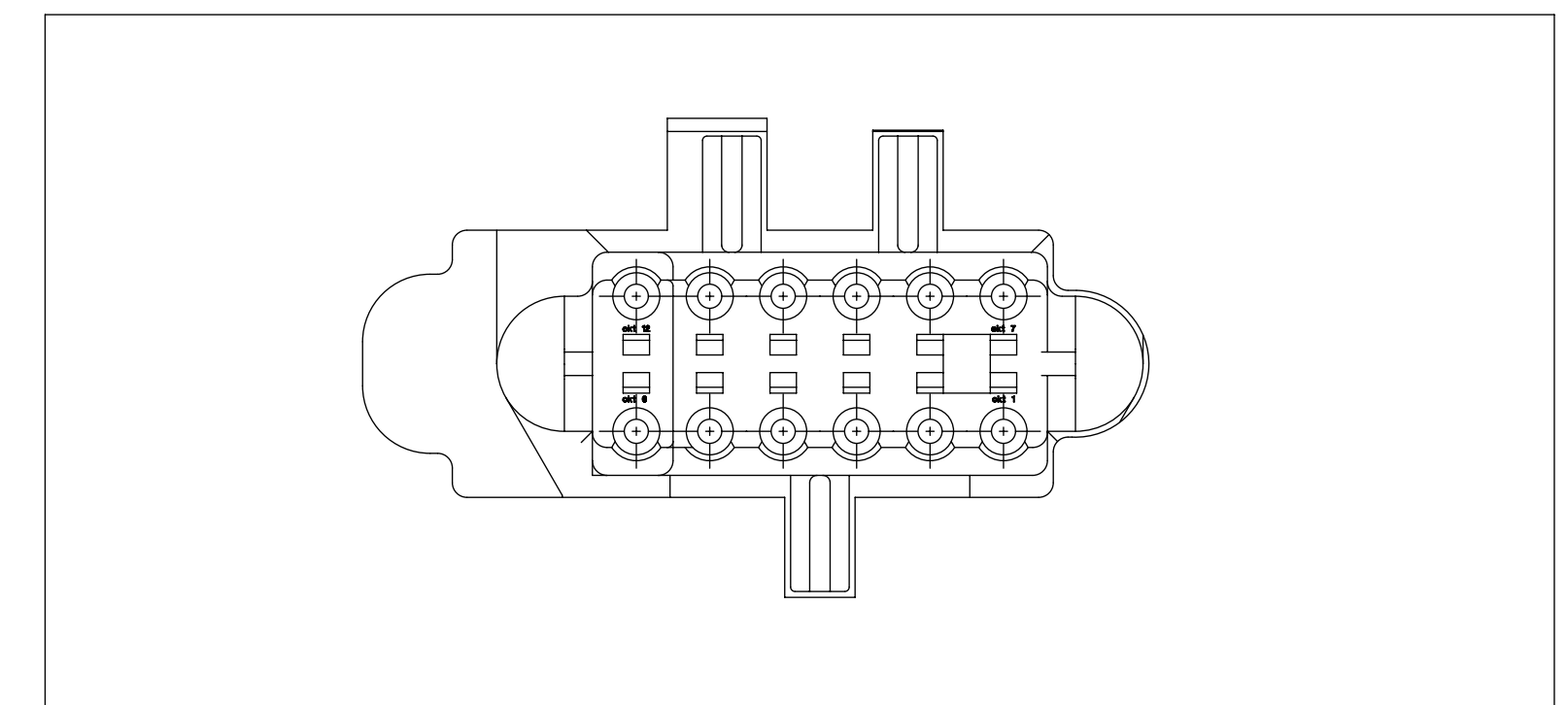

RECEPTACLE
INSERT POSITIONING

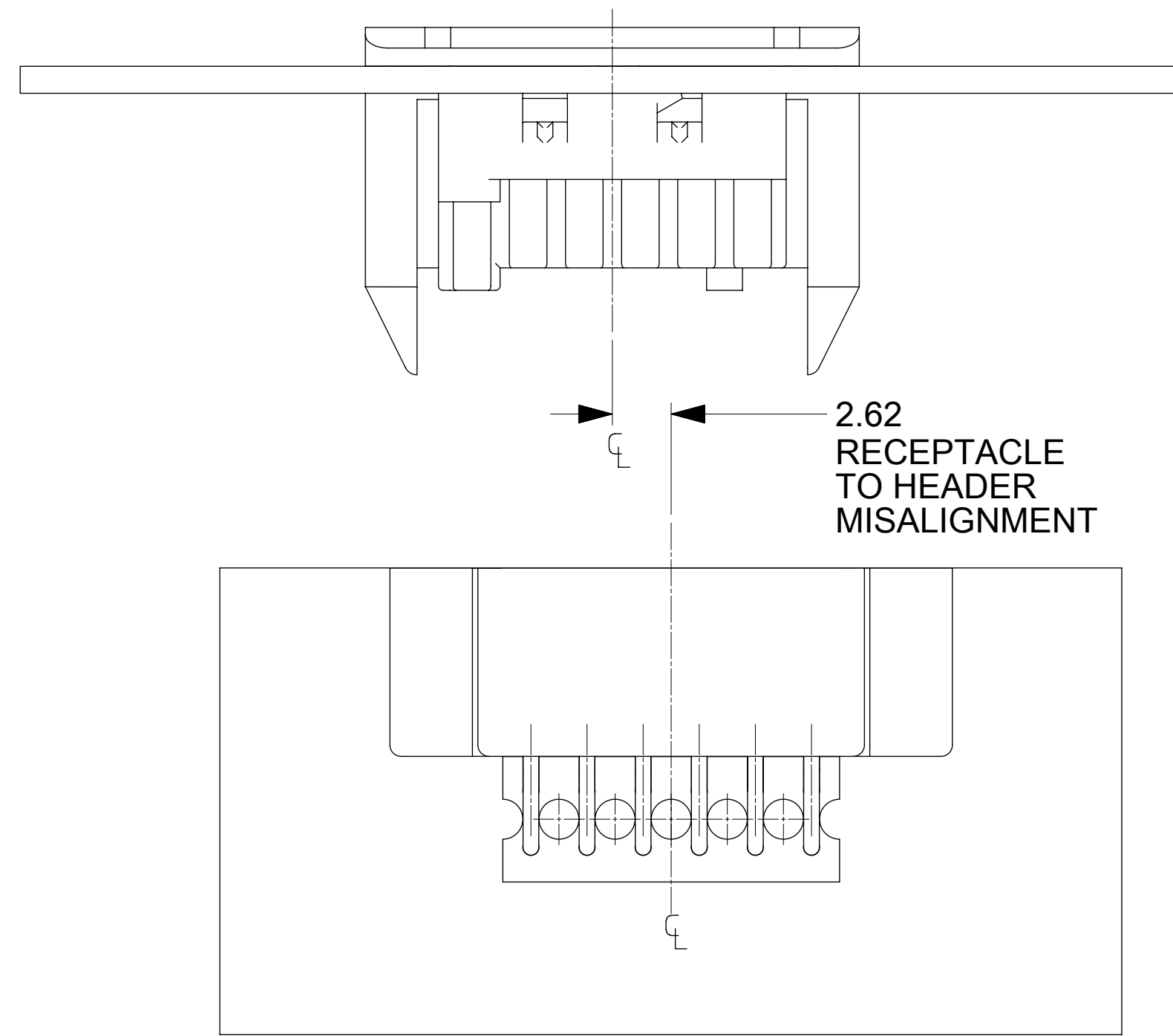

2.62
RECEPTACLE
TO HEADER
MISALIGNMENT

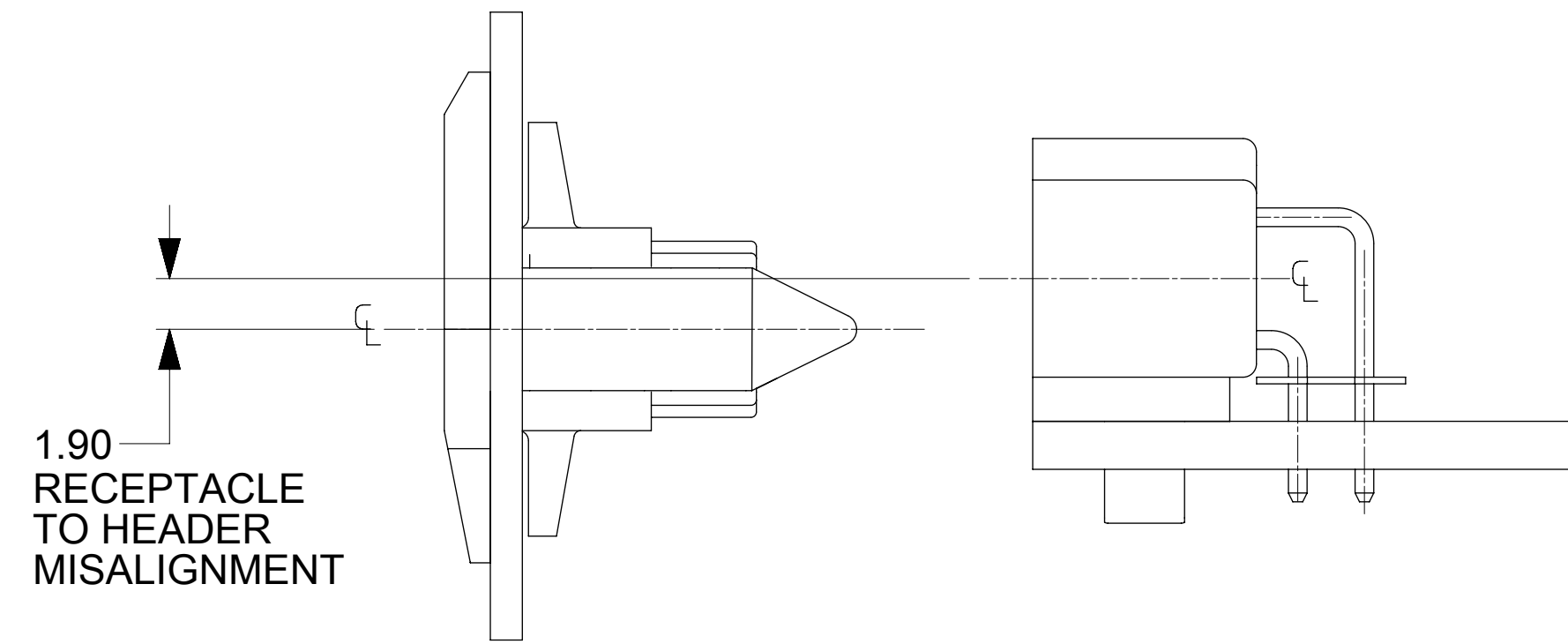

1.90
RECEPTACLE
TO HEADER
MISALIGNMENT

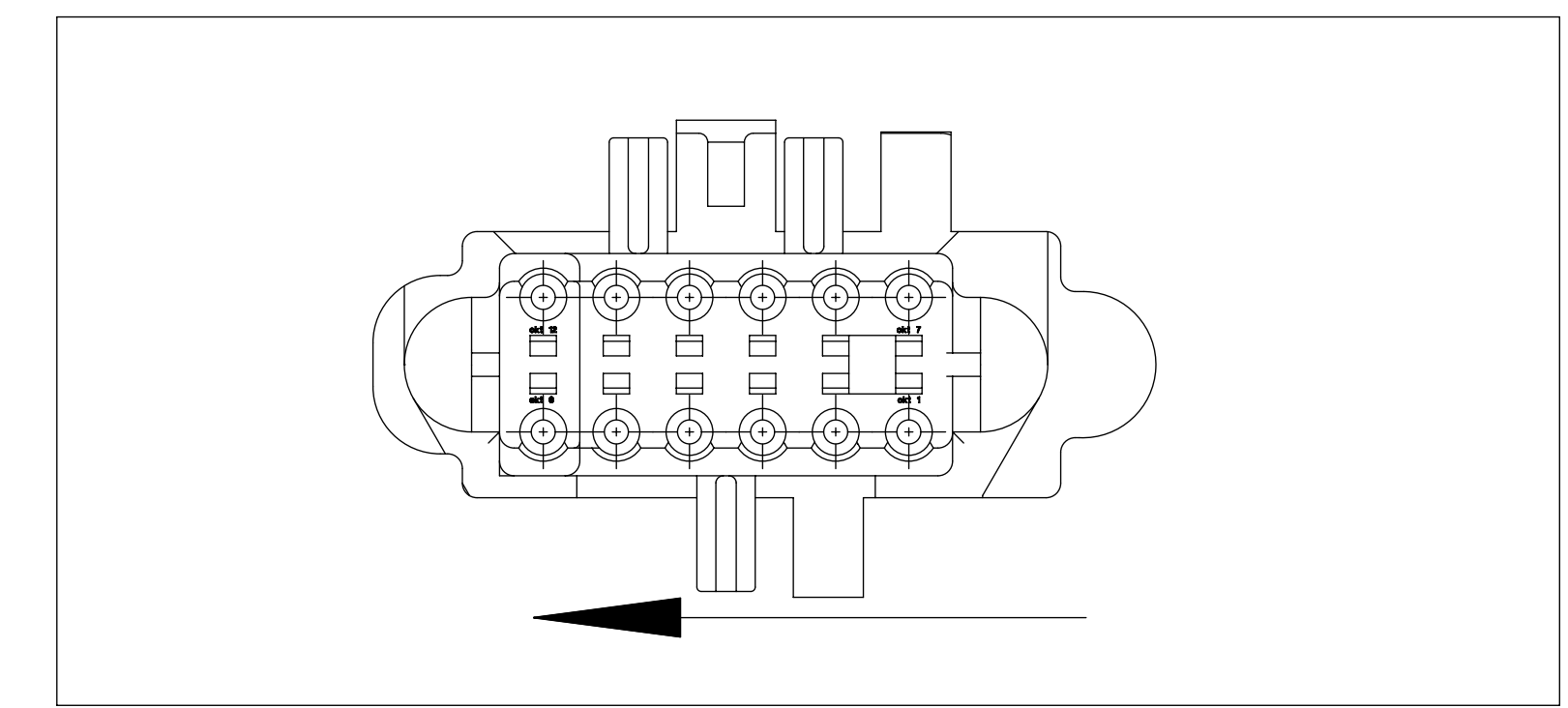

RECEPTACLE SLIDES
INTO MOUNTED POSITION

THIS DRAWING CONTAINS INFORMATION THAT IS PROPRIETARY TO MOLEX ELECTRONIC TECHNOLOGIES, LLC AND SHOULD NOT BE USED WITHOUT WRITTEN PERMISSION									
DIMENSION UNITS		SCALE		CURRENT REV DESC:					
MM		4:1							
GENERAL TOLERANCES (UNLESS SPECIFIED)				EC NO: 625546					
				DRWN: RLALSANGI		2017/09/11		SPOX BMI RECEPTACLE HOUSING, 12 PIN PANEL MOUNT	
4 PLACES ±		±		CHK'D: ISHWARG		2019/10/18		PRODUCT CUSTOMER DRAWING	
3 PLACES ±		±		APPR: ISHWARG		2019/10/18		DOCUMENT NUMBER	
2 PLACES ±		0.25 ±		INITIAL REVISION:				DOC TYPE	
1 PLACE ±		0.3 ±		DRWN: DROSCA		2006/09/06		DOC PART	
0 PLACES ±		±		APPR: JCOMERCI		2006/09/06		REVISION	
ANGULAR TOL ±		0.5 °		SERIES		45609		SD-45609-012	
DRAFT WHERE APPLICABLE MUST REMAIN WITHIN DIMENSIONS				THIRD ANGLE PROJECTION		DRAWING		MATERIAL NUMBER	
				D-SIZE		45609		CUSTOMER	
								IBM	
								SHEET NUMBER	
								2 OF 2	