

280362 ✓ ACTIVE

AMPMODU | AMPMODU IV/V

TE Internal #: 280362

Housing, Receptacle, Wire-to-Board, 10 Position, .1 in [2.54 mm]
Centerline, Crimp, 1 Row, Black, Mating Retention, Wire & Cable,
Signal, AMPMODU IV/V

[View on TE.com >](#)



Connectors > PCB Connectors > Wire-to-Board Connectors > Wire-to-Board Connector Assemblies & Housings



Connector Product Type: **Housing**

Connector & Housing Type: **Receptacle**

Connector System: **Wire-to-Board**

Number of Positions: **10**

Centerline (Pitch): **2.54 mm [.1 in]**

Features

Product Type Features

Connector Product Type	Housing
Connector & Housing Type	Receptacle
Connector System	Wire-to-Board
Connector & Contact Terminates To	Wire & Cable

Configuration Features

Number of Positions	10
Number of Rows	1

Body Features

Primary Product Color	Black
-----------------------	-------

Contact Features

Contact Layout	Inline
Contact Type	Socket
Contact Current Rating (Max)	3 A



Termination Features

Termination Method to Wire & Cable	Crimp
------------------------------------	-------

Mechanical Attachment

Panel Mount Feature	Without
PCB Mount Retention	Without
Mating Retention Type	Detent Latching
Mating Retention	With
Connector Mounting Type	Cable Mount (Free-Hanging)

Housing Features

Housing Entry Configuration	Both Ends Closed
Housing Material	LCP (Liquid Crystal Polymer)
Centerline (Pitch)	2.54 mm[.1 in]

Dimensions

Connector Length	7.1 mm
Connector Height	3.1 mm[.12 in]
Row-to-Row Spacing	2.54 mm[.1 in]

Usage Conditions

Operating Temperature Range	-40 – 80 °C[-40 – 176 °F]
-----------------------------	---------------------------

Operation/Application

Circuit Application	Signal
---------------------	--------

Industry Standards

Glow Wire Rating	Standard Part - Not Glow Wire
UL Flammability Rating	UL 94V-0

Packaging Features

Packaging Quantity	1000
Packaging Method	Bag

Product Compliance

[For compliance documentation, visit the product page on TE.com>](#)

EU RoHS Directive 2011/65/EU	Compliant
EU ELV Directive 2000/53/EC	Compliant
China RoHS 2 Directive MIIT Order No 32, 2016	No Restricted Materials Above Threshold

EU REACH Regulation (EC) No. 1907/2006

Current ECHA Candidate List: JUNE 2023 (235)

Candidate List Declared Against: JUNE 2023 (235)

Does not contain REACH SVHC

Halogen Content

Low Halogen - Br, Cl, F, I < 900 ppm per homogenous material. Also BFR/CFR/PVC Free

Solder Process Capability

Not applicable for solder process capability

Product Compliance Disclaimer

This information is provided based on reasonable inquiry of our suppliers and represents our current actual knowledge based on the information they provided. This information is subject to change. The part numbers that TE has identified as EU RoHS compliant have a maximum concentration of 0.1% by weight in homogenous materials for lead, hexavalent chromium, mercury, PBB, PBDE, DBP, BBP, DEHP, DIBP, and 0.01% for cadmium, or qualify for an exemption to these limits as defined in the Annexes of Directive 2011/65/EU (RoHS2). Finished electrical and electronic equipment products will be CE marked as required by Directive 2011/65/EU. Components may not be CE marked. Additionally, the part numbers that TE has identified as EU ELV compliant have a maximum concentration of 0.1% by weight in homogenous materials for lead, hexavalent chromium, and mercury, and 0.01% for cadmium, or qualify for an exemption to these limits as defined in the Annexes of Directive 2000/53/EC (ELV). Regarding the REACH Regulation, the information TE provides on SVHC in articles for this part number is based on the latest European Chemicals Agency (ECHA) 'Guidance on requirements for substances in articles' posted at this URL: <https://echa.europa.eu/guidance-documents/guidance-on-reach>

Compatible Parts



TE Part # 280381-2
10P MODU II SHRD HDR,RT ANG, 0.38 AU



TE Part # 87077-2
MOD IV KEYING PLUG



TE Part # 280374-2
10P AMPMODU II SHRD HDR, ST, 0.38 AU



TE Part # 181270-1
AMP-MODU CONTACT



TE Part # 181270-2
MOD II CONTACT L.P.



TE Part # 181270-3
MOD 2 BUCHSE



TE Part # 280374-1
10P AMPMODU II SHRD HDR, ST, TIN



TE Part # 280530-4
MOD2 BUCHSE

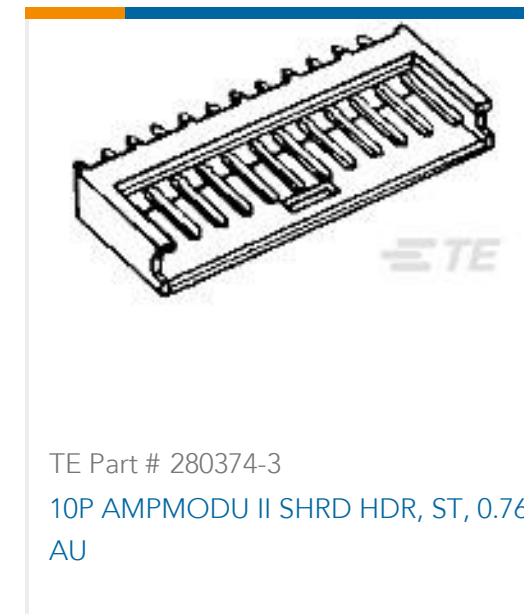
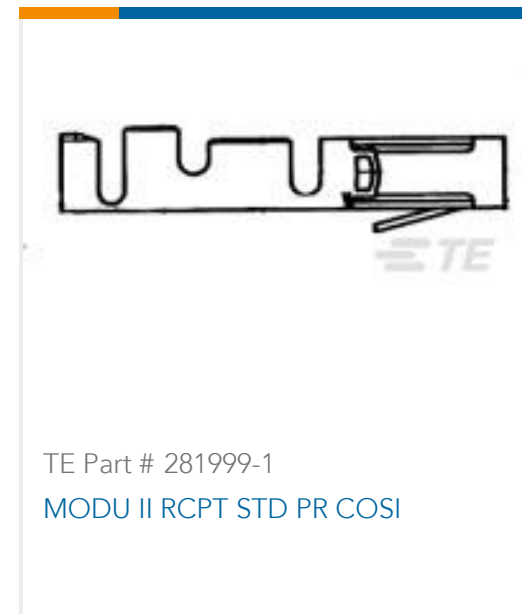
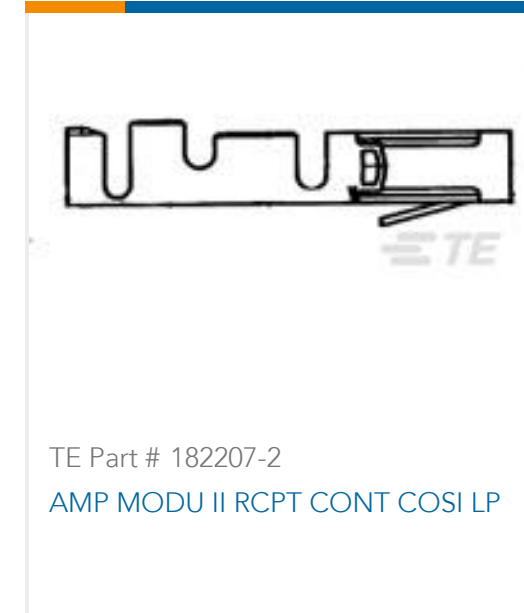
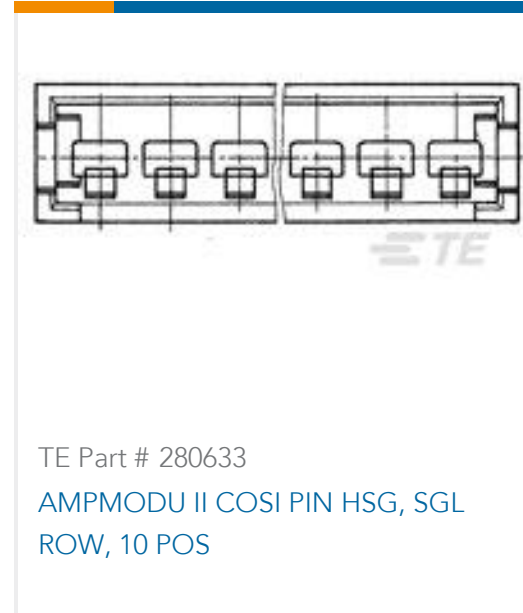

Also in the Series | AMPMODU IV/V

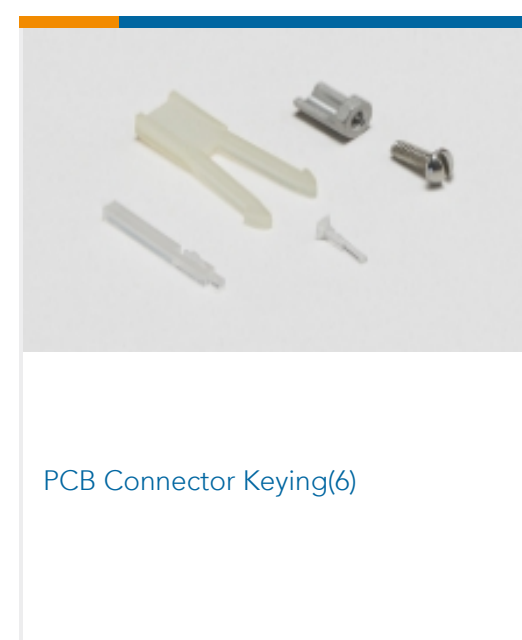
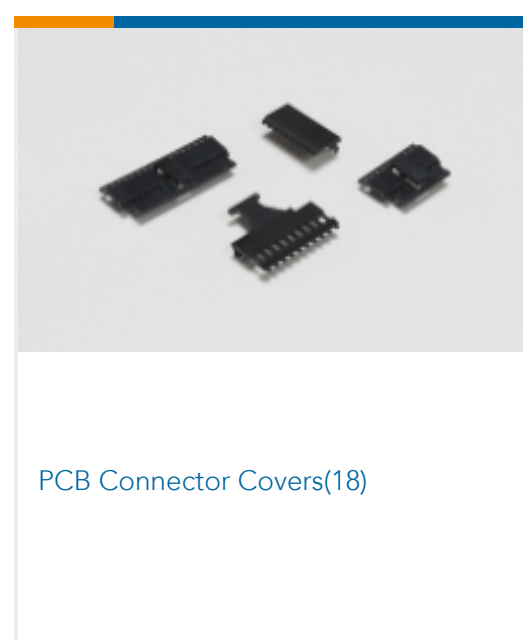
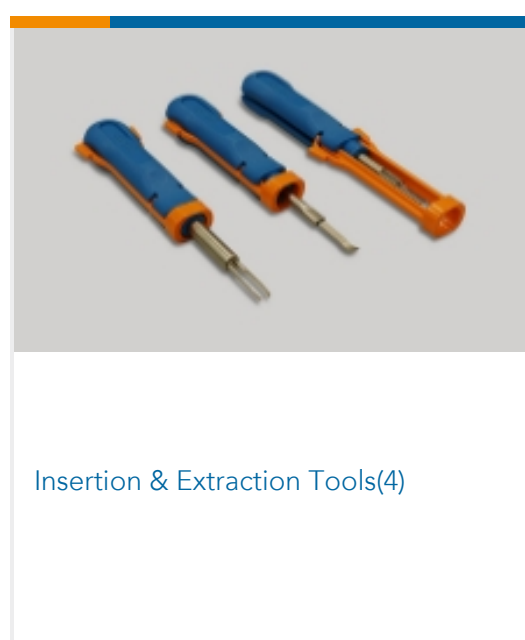
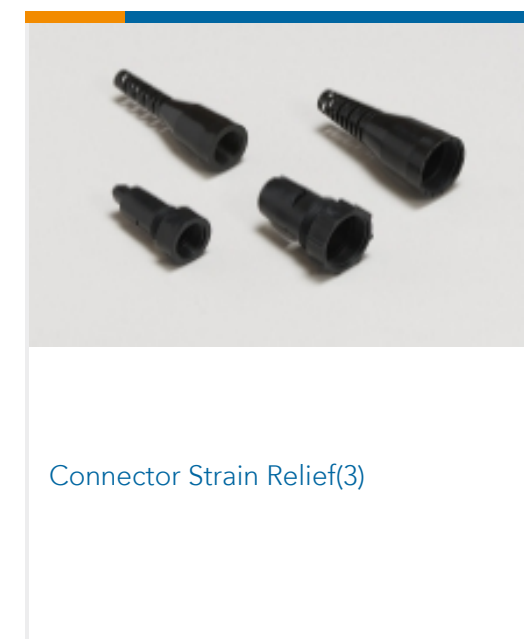
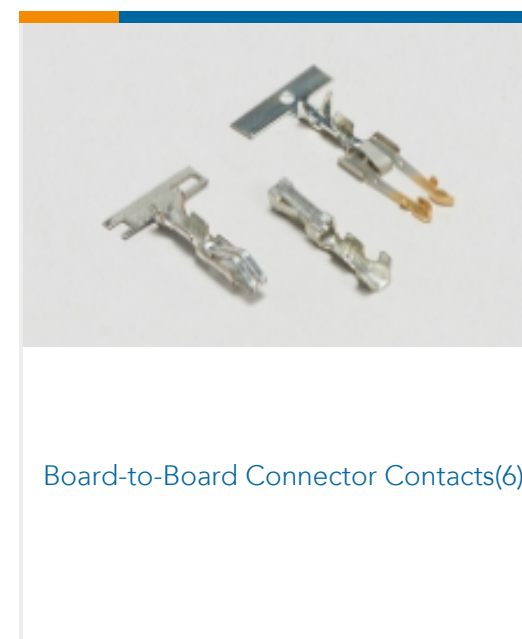
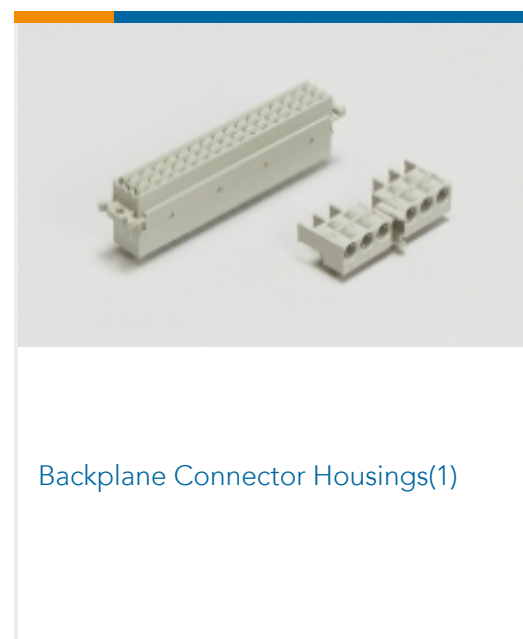
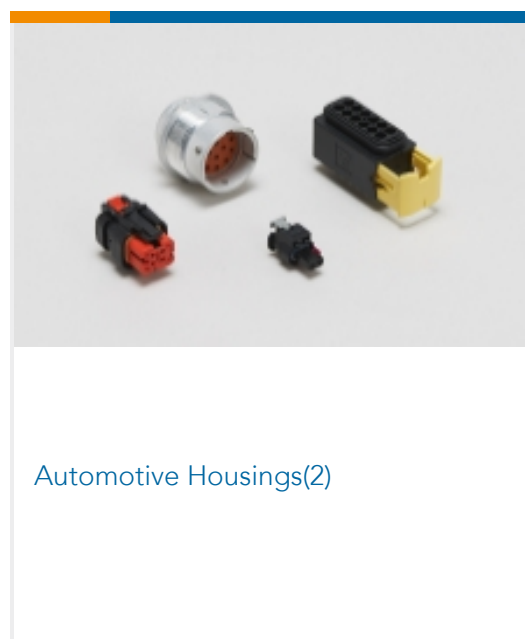

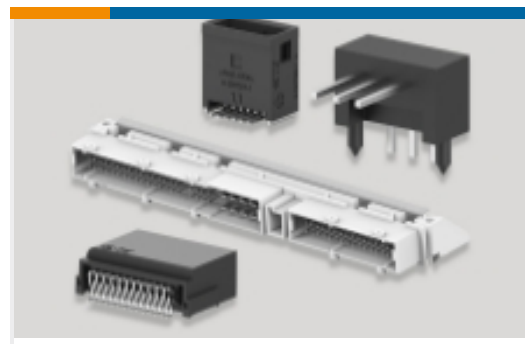

PCB Headers & Receptacles(934)

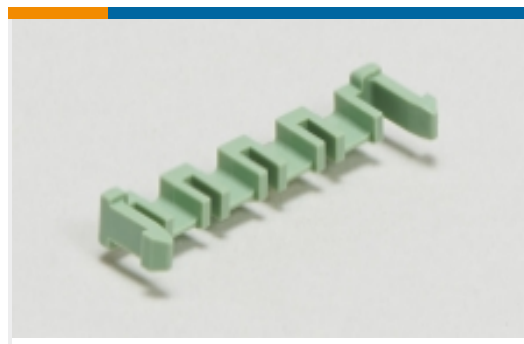

PCB Latches, Locks & Retainers(7)



Rectangular Connector Housings(5)

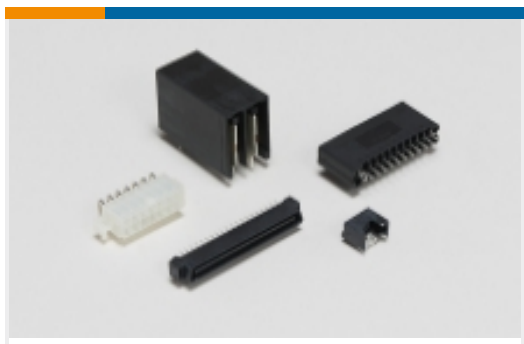

Standard Rectangular Connectors(8)



Wire-to-Board Connector Assemblies & Housings(447)



Wire-to-Board Connector Contacts (322)

Customers Also Bought



TE Part #280514
AMPMODU II REC. HSG, SINGLE ROW, 12 POS.

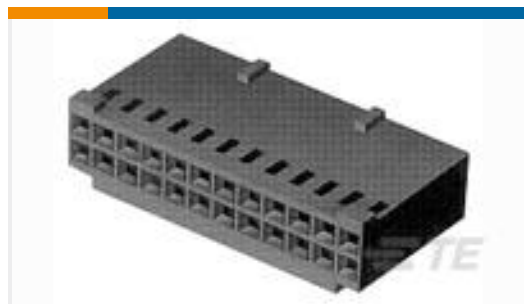

TE Part #280365
AMPMODU, DBL ROW, CONTACT REC

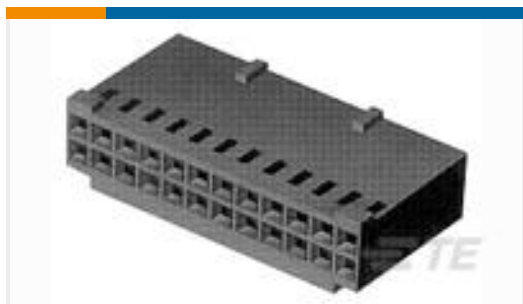

TE Part #280513
AMPMODU II REC. HSG, DUAL ROW, 18 POS



TE Part #280359
AMPMODU II REC. HSG, SINGLE ROW, 4 POS.

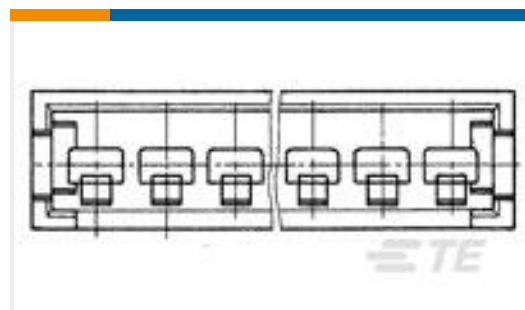

TE Part #280628
AMPMODU II COSI PIN HSG, SGL ROW, 2 POS.



TE Part #280381-1
10P MODU II SHRD HDR, RT ANG, TIN



TE Part #A611044001
VERSAFLEX-08-0-SP

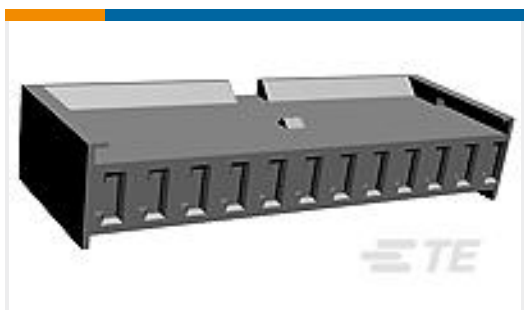

TE Part #280595
AMP MODU MOD I RECEPT HSG



TE Part #2-826631-4
24P MOD2 STIFT LEI

Documents



CAD Files

3D PDF

3D

Customer View Model

[ENG_CVM_CVM_280362_Z.2d_dxf.zip](#)

English

Customer View Model

[ENG_CVM_CVM_280362_Z.3d_igs.zip](#)

English

Customer View Model

[ENG_CVM_CVM_280362_Z.3d_stp.zip](#)

English

By downloading the CAD file I accept and agree to the [Terms and Conditions](#) of use.

Product Environmental Compliance

[MD_280362_0713201770_dmtec](#)

English

[MD_280362_0713201770_dmtec](#)

English