



# Multilayer Ceramic Capacitors

## Series/Type: B37984

The following products presented in this data sheet are being withdrawn.

Ordering Code	Substitute Product	Date of Withdrawal	Deadline Last Orders	Last Shipments
B37984M5334K054		2008-08-01	2009-07-31	2009-10-31
B37984M5334K051		2008-08-01	2009-07-31	2009-10-31
B37984M5334K000		2008-08-01	2009-07-31	2009-10-31



Ordering Code	Substitute Product	Date of Withdrawal	Deadline Last Orders	Last Shipments
B37984M5474K054		2008-08-01	2009-07-31	2009-10-31
B37984M5474K051		2008-08-01	2009-07-31	2009-10-31
B37984M5474K000		2008-08-01	2009-07-13	2009-10-31

For further information please contact your nearest EPCOS sales office, which will also support you in selecting a suitable substitute. The addresses of our worldwide sales network are presented at [www.epcos.com/sales](http://www.epcos.com/sales).

Ordering code system

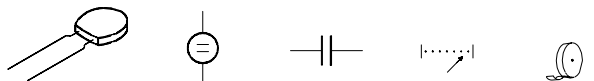

**B37979N**    **1**    **100**    **K**    **0**    **54**

**Packaging**

51  $\triangleq$  cardboard tape, reel packing (360-mm reel)  
**54  $\triangleq$  Ammo packing (standard)**  
 00  $\triangleq$  bulk

**Internal coding**

**Capacitance tolerance**

**J  $\triangleq$   $\pm$  5% (standard for C0G)**  
**K  $\triangleq$   $\pm$  10% (standard for X7R)**  
**M  $\triangleq$   $\pm$  20% (standard for Z5U (Y5U))**

**Capacitance**, coded    101  $\triangleq$  10 · 10<sup>1</sup> pF = 100 pF  
 (example)                    222  $\triangleq$  22 · 10<sup>2</sup> pF = 2.2 nF  
                                       473  $\triangleq$  47 · 10<sup>3</sup> pF = 47 nF

**Rated voltage**

Rated voltage [VDC]	50	100
Code	5	1

<b>Type and size</b>			
With radial leads EIA standard	Temperature characteristic		
	C0G	X7R	Z5U (Y5U)
Lead spacing 2.5 mm 5.5 × 5.0 × 2.5 6.5 × 5.0 × 2.5	B37979N B37986N	B37981M B37987M	B37982N B37988N
Lead spacing 5.0 mm 5.5 × 5.0 × 2.5 6.5 × 5.0 × 2.5 9.0 × 7.5 × 2.5	B37979G B37986G —	B37981F B37987F B37984M	B37982G B37988G B37985N

**Features**

- High volumetric efficiency
- Non-linear capacitance change
- High insulation resistance
- High pulse strength
- To AEC-Q200

**Applications**

- Blocking
- Coupling and decoupling
- Interference suppression

**Termination**

- Parallel wire leads, iron-nickel, tinned
- Crimped leads
- Non-standard lead lengths on request

**Marking**

- Rated capacitance, tolerance, manufacturer's logo, ceramic material, voltage

**Delivery mode**

- Cardboard tape in Ammo packing (standard)
- Cardboard tape on 360-mm reel or bulk on request

**Electrical data**

Temperature characteristic		X7R	
Max. relative capacitance change within $-55\text{ °C}$ to $+125\text{ °C}$	$\Delta C/C$	$\pm 15$	%
Climatic category (IEC 60068-1)		55/125/56	
Standard		EIA	
Dielectric		Class 2	
Rated voltage <sup>1)</sup>	$V_R$	50, 100	VDC
Test voltage	$V_{\text{test}}$	$2.5 \cdot V_R/5\text{ s}$	VDC
Capacitance range / E series	$C_R$	470 pF ... 1 $\mu\text{F}$ (E6)	
Dissipation factor (limit value)	$\tan \delta$	$< 25 \cdot 10^{-3}$	
Insulation resistance <sup>2)</sup> at $+ 25\text{ °C}$	$R_{\text{ins}}$	$> 10^5$	$\text{M}\Omega$
Insulation resistance <sup>2)</sup> at $+125\text{ °C}$	$R_{\text{ins}}$	$> 10^4$	$\text{M}\Omega$
Time constant <sup>2)</sup> at $+ 25\text{ °C}$	$\tau$	$> 1000$	s
Time constant <sup>2)</sup> at $+125\text{ °C}$	$\tau$	$> 100$	s
Operating temperature range	$T_{\text{op}}$	$-55 \dots +125$	$^{\circ}\text{C}$
Ageing <sup>3)</sup>		yes	

1) Note: No operation on AC line.

2) For  $C_R > 10\text{ nF}$  the time constant  $\tau = C \cdot R_{\text{ins}}$  is given.

3) Refer to chapter "General technical information", "Ageing".

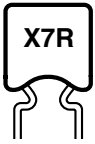

## Multilayer ceramic capacitors

X7R

### Capacitance tolerances

Code letter	K (standard)	M
Tolerance	±10%	±20%

### Dimensional drawing

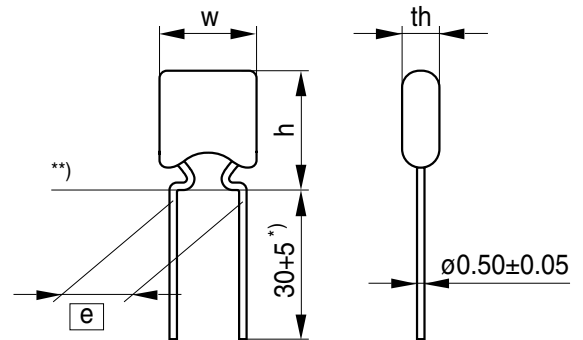

\*) Lead length for bulk packaging

\*\*) Seating plane to IEC 600717

KKE0456-R-E

### Dimensions (mm)

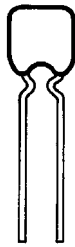
	Lead spacing $\boxed{e}$ = 2.5 +0.6/-0.1 mm	
Type	B37981M	B37987M
		
$h_{\max}$	5.5	6.5
$w_{\max}$	5.0	5.0
$th_{\max}$	2.5	2.5

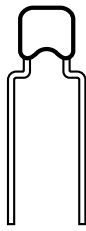
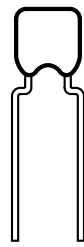
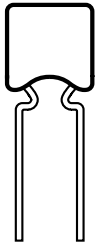
	Lead spacing $\boxed{e}$ = 5.0 +0.6/-0.1 mm		
Type	B37981F	B37987F	B37984M
			
$h_{\max}$	5.5	6.5	9.0
$w_{\max}$	5.0	5.0	7.5
$th_{\max}$	2.5	2.5	2.5



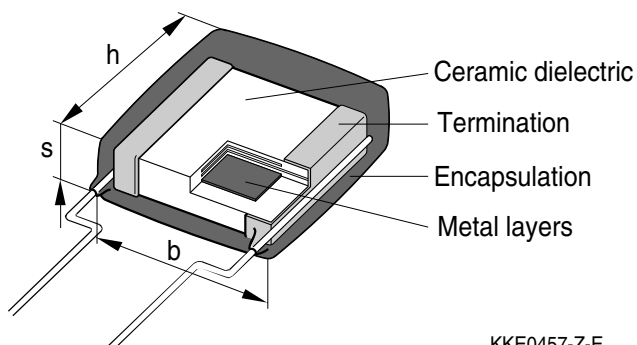

### Termination

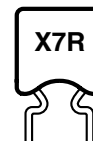

KKE0457-Z-E

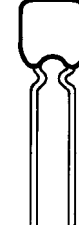

Product range leaded capacitors, X7R

Lead spacing	2.5 mm				5.0 mm					
										
h × b × s (mm)	5.5 × 5.0 × 2.5		6.5 × 5.0 × 2.5		5.5 × 5.0 × 2.5		6.5 × 5.0 × 2.5		9.0 × 7.5 × 2.5	
Type	B37981M		B37987M		B37981F		B37987F		B37984M	
C <sub>R</sub>	V <sub>R</sub> (VDC)		50		100		50		100	
	50	100	50	100	50	100	50	100	50	
470 pF										
680 pF										
1.0 nF										
1.5 nF										
2.2 nF										
3.3 nF										
4.7 nF										
6.8 nF										
10 nF										
15 nF										
22 nF										
33 nF										
47 nF										
68 nF										
100 nF										
150 nF										
220 nF										
330 nF										
470 nF										
680 nF										
1.0 μF										

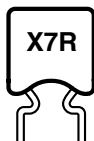
**Multilayer ceramic capacitors**
**X7R**
**Ordering codes and packing for X7R, 50 VDC, lead spacing 2.5 mm**

C <sub>R</sub>	Ordering code <sup>1)</sup>	Ammo packing	Reel packing	Bulk
		** $\triangle$ 54	** $\triangle$ 51	** $\triangle$ 00
		pcs	pcs/reel	pcs

**B37981, 50 VDC**

3.3 nF	B37981M5332K0**	2500	2500	2000
4.7 nF	B37981M5472K0**	2500	2500	2000
6.8 nF	B37981M5682K0**	2500	2500	2000
10 nF	B37981M5103K0**	2500	2500	2000
15 nF	B37981M5153K0**	2500	2500	2000
22 nF	B37981M5223K0**	2500	2500	2000
33 nF	B37981M5333K0**	2500	2500	2000
47 nF	B37981M5473K0**	2500	2500	2000

**B37987, 50 VDC**

68 nF	B37987M5683K0**	2500	2500	2000
100 nF	B37987M5104K0**	2500	2500	2000
150 nF	B37987M5154K0**	2500	2500	2000
220 nF	B37987M5224K0**	2500	2500	2000

1) The table contains the ordering codes for the standard capacitance tolerance.  
For other available capacitance tolerances see page 4.

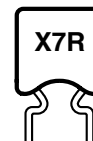
**Ordering codes and packing for X7R, 50 VDC, lead spacing 5.0 mm**

C <sub>R</sub>	Ordering code <sup>1)</sup>	Ammo packing	Reel packing	Bulk
		** $\triangle$ 54	** $\triangle$ 51	** $\triangle$ 00
		pcs	pcs/reel	pcs

**B37981, 50 VDC**

3.3 nF	B37981F5332K0**	2500	2500	2000
4.7 nF	B37981F5472K0**	2500	2500	2000
6.8 nF	B37981F5682K0**	2500	2500	2000
10 nF	B37981F5103K0**	2500	2500	2000
15 nF	B37981F5153K0**	2500	2500	2000
22 nF	B37981F5223K0**	2500	2500	2000
33 nF	B37981F5333K0**	2500	2500	2000
47 nF	B37981F5473K0**	2500	2500	2000

**B37987, 50 VDC**

68 nF	B37987F5683K0**	2500	2500	2000
100 nF	B37987F5104K0**	2500	2500	2000
150 nF	B37987F5154K0**	2500	2500	2000
220 nF	B37987F5224K0**	2500	2500	2000

**B37984, 50 VDC**

330 nF	B37984M5334K0**	2000	2000	2000
470 nF	B37984M5474K0**	2000	2000	2000
680 nF	B37984M5684K0**	2000	2000	2000
1.0 $\mu$ F	B37984M5105K0**	2000	2000	2000

1) The table contains the ordering codes for the standard capacitance tolerance.  
For other available capacitance tolerances see page 4.



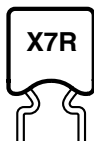

## Multilayer ceramic capacitors

### X7R

#### Ordering codes and packing for X7R, 100 VDC, lead spacing 2.5 mm

C <sub>R</sub>	Ordering code <sup>1)</sup>	Ammo packing	Reel packing	Bulk
		** $\triangle$ 54	** $\triangle$ 51	** $\triangle$ 00
		pcs	pcs/reel	pcs

#### B37981, 100 VDC

470 pF	B37981M1471K0**	2500	2500	2000
680 pF	B37981M1681K0**	2500	2500	2000
1.0 nF	B37981M1102K0**	2500	2500	2000
1.5 nF	B37981M1152K0**	2500	2500	2000
2.2 nF	B37981M1222K0**	2500	2500	2000
3.3 nF	B37981M1332K0**	2500	2500	2000
4.7 nF	B37981M1472K0**	2500	2500	2000
6.8 nF	B37981M1682K0**	2500	2500	2000
10 nF	B37981M1103K0**	2500	2500	2000
15 nF	B37981M1153K0**	2500	2500	2000

#### B37987, 100 VDC

22 nF	B37987M1223K0**	2500	2500	2000
33 nF	B37987M1333K0**	2500	2500	2000
47 nF	B37987M1473K0**	2500	2500	2000
68 nF	B37987M1683K0**	2500	2500	2000
100 nF	B37987M1104K0**	2500	2500	2000
150 nF	B37987M1154K0**	2500	2500	2000

1) The table contains the ordering codes for the standard capacitance tolerance.  
For other available capacitance tolerances see page 4.

**Ordering codes and packing for X7R, 100 VDC, lead spacing 5.0 mm**

C <sub>R</sub>	Ordering code <sup>1)</sup>	Ammo packing	Reel packing	Bulk
		** $\triangle$ 54	** $\triangle$ 51	** $\triangle$ 00
		pcs/reel	pcs	pcs

**B37981, 100 VDC**

470 pF	B37981F1471K0**	2500	2500	2000
680 pF	B37981F1681K0**	2500	2500	2000
1.0 nF	B37981F1102K0**	2500	2500	2000
1.5 nF	B37981F1152K0**	2500	2500	2000
2.2 nF	B37981F1222K0**	2500	2500	2000
3.3 nF	B37981F1332K0**	2500	2500	2000
4.7 nF	B37981F1472K0**	2500	2500	2000
6.8 nF	B37981F1682K0**	2500	2500	2000
10 nF	B37981F1103K0**	2500	2500	2000
15 nF	B37981F1153K0**	2500	2500	2000

**B37987, 100 VDC**

22 nF	B37987F1223K0**	2500	2500	2000
33 nF	B37987F1333K0**	2500	2500	2000
47 nF	B37987F1473K0**	2500	2500	2000
68 nF	B37987F1683K0**	2500	2500	2000
100 nF	B37987F1104K0**	2500	2500	2000
150 nF	B37987F1154K0**	2500	2500	2000

1) The table contains the ordering codes for the standard capacitance tolerance.  
For other available capacitance tolerances see page 4.

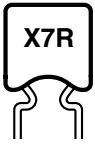

## Multilayer ceramic capacitors

X7R

### Typical characteristics

Capacitance change  $\Delta C/C_{25}$  versus temperature T

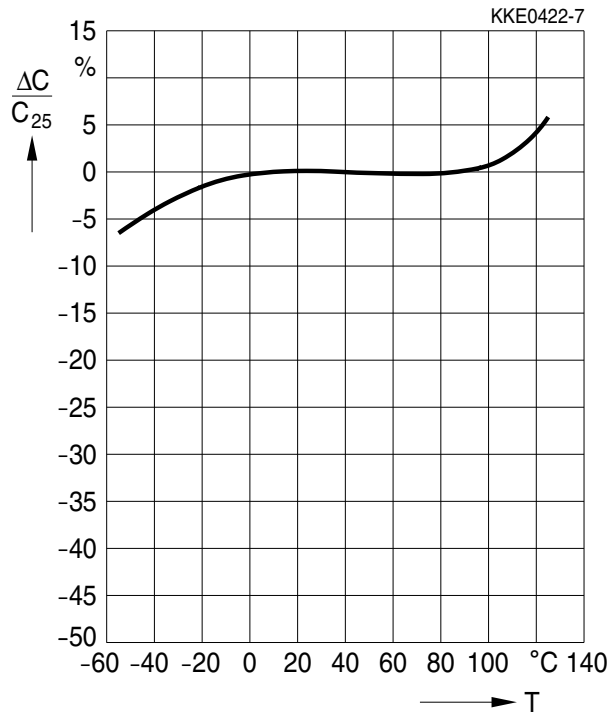

Capacitance change  $\Delta C/C_0$  versus superimposed DC voltage V

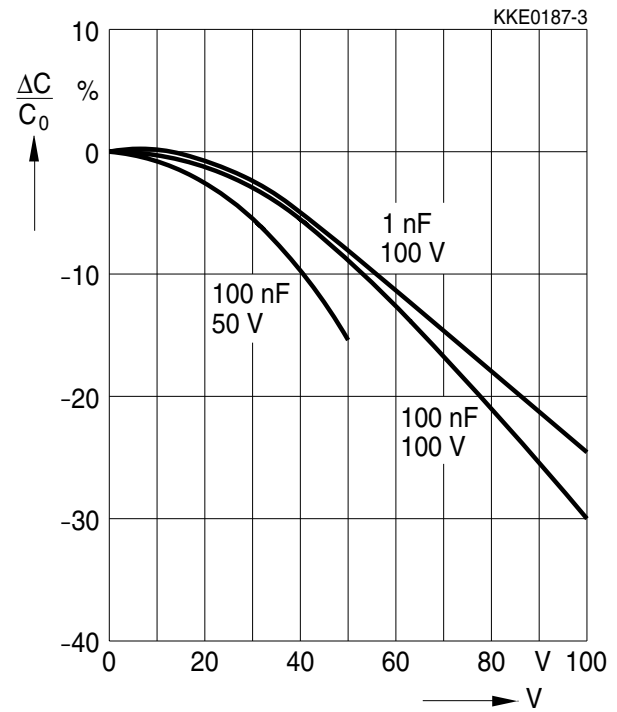

Insulation resistance  $R_{ins}$  versus temperature T

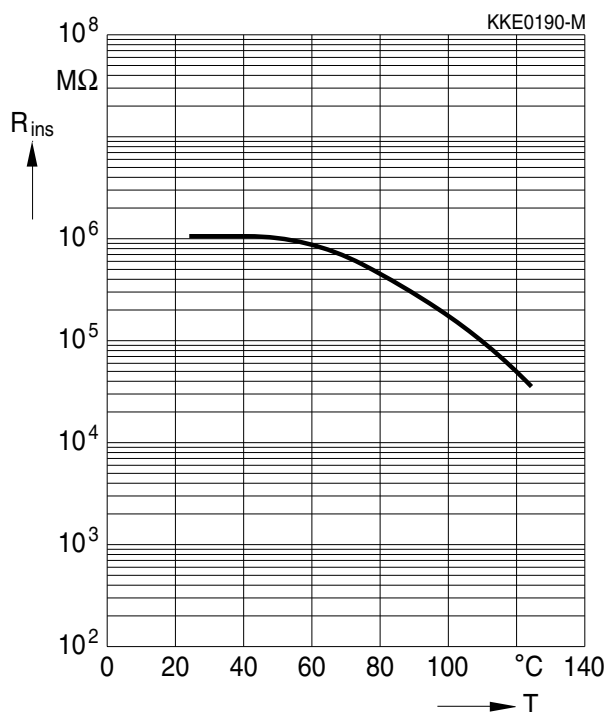

Dissipation factor  $\tan \delta$  versus temperature T

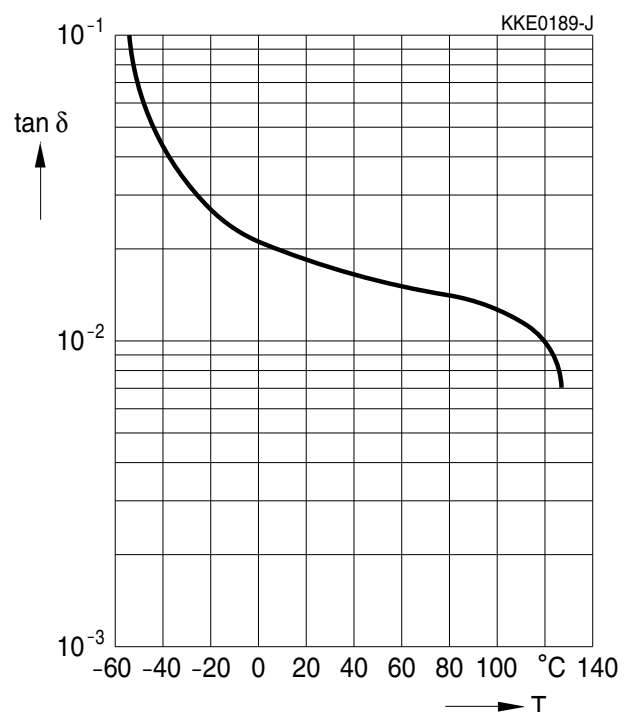

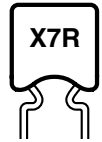

**Typical characteristics**

Impedance  $|Z|$  versus frequency  $f$

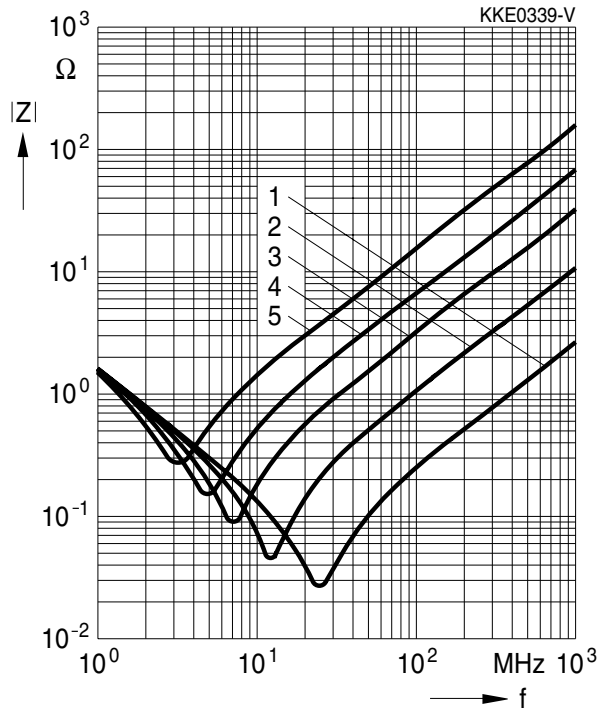

- 1: SMD chip capacitor
- 2: 1.5 mm lead length
- 3: 5.0 mm lead length
- 4: 10.0 mm lead length
- 5: 20.0 mm lead length

Capacitance change  $\Delta C/C_1$  versus time  $t$

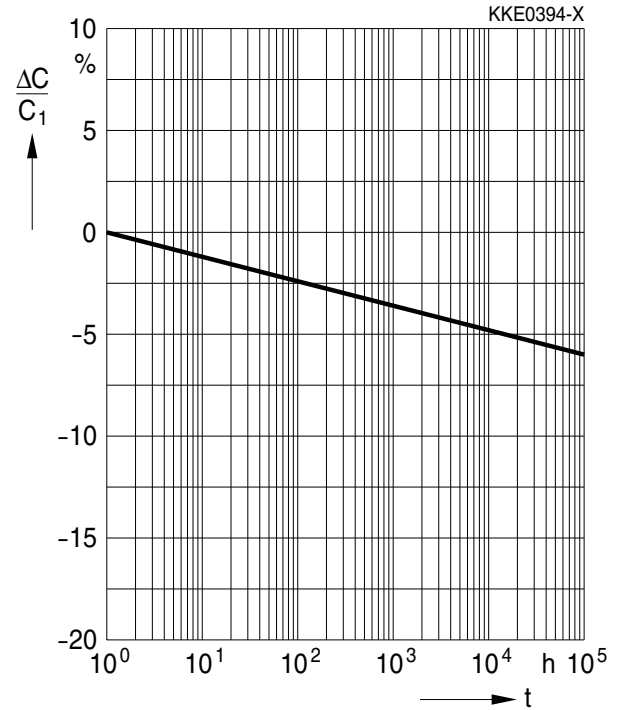

### Notes on the selection of ceramic capacitors

In the selection of ceramic capacitors, the following criteria must be considered:

1. Depending on the application, ceramic capacitors used to meet high quality requirements should at least satisfy the specifications to AEC-Q200. They must meet quality requirements going beyond this level in terms of ruggedness (e.g. mechanical, thermal or electrical) in the case of critical circuit configurations and applications (e.g. in safety-relevant applications such as ABS and airbag equipment or durable industrial goods).
2. At the connection to the battery or power supply (e.g. clamp 15 or 30 in the automobile) and at positions with stranding potential, to reduce the probability of short circuits following a fracture, two ceramic capacitors must be connected in series and/or a ceramic capacitor with integrated series circuit should be used. The MLSC from EPCOS contains such a series circuit in a single component.
3. Ceramic capacitors with the temperature characteristics Z5U and Y5V do not satisfy the requirements to AEC-Q200 and are mechanically and electrically less rugged than C0G or X7R/X8R ceramic capacitors. In applications that must satisfy high quality requirements, therefore, these capacitors should not be used as discrete components (see the chapter “Effects on mechanical, thermal and electrical stress”, point 1.4).
4. For ESD protection, preference should be given to the use of multilayer varistors (MLV) (see the chapter “Effects on mechanical, thermal and electrical stress”, point 1.4).
5. An application-specific derating or continuous operating voltage must be considered in order to cushion (unexpected) additional stresses (see the chapter “Reliability”).

### The following should be considered in circuit board design

1. If technically feasible in the application, preference should be given to components having an optimal geometrical design.
2. At least FR4 circuit board material should be used.
3. Geometrically optimal circuit boards should be used, ideally those that cannot be deformed.
4. Ceramic capacitors must always be placed a sufficient minimum distance from the edge of the circuit board. High bending forces may be exerted there when the panels are separated and during further processing of the board (such as when incorporating it into a housing).
5. Ceramic capacitors should always be placed parallel to the possible bending axis of the circuit board.
6. No screw connections should be used to fix the board or to connect several boards. Components should not be placed near screw holes. If screw connections are unavoidable, they must be cushioned (for instance by rubber pads).

**The following should be considered in the placement process**

1. Ensure correct positioning of the ceramic capacitor on the solder pad.
2. Caution when using casting, injection-molded and molding compounds and cleaning agents, as these may damage the capacitor.
3. Support the circuit board and reduce the placement forces.
4. A board should not be straightened (manually) if it has been distorted by soldering.
5. Separate panels with a peripheral saw, or better with a milling head (no dicing or breaking).
6. Caution in the subsequent placement of heavy or leaded components (e.g. transformers or snap-in components): danger of bending and fracture.
7. When testing, transporting, packing or incorporating the board, avoid any deformation of the board not to damage the components.
8. Avoid the use of excessive force when plugging a connector into a device soldered onto the board.
9. Ceramic capacitors must be soldered only by the mode (reflow or wave soldering) permissible for them (see the chapter "Soldering directions").
10. When soldering the most gentle solder profile feasible should be selected (heating time, peak temperature, cooling time) in order to avoid thermal stresses and damage.
11. Ensure the correct solder meniscus height and solder quantity.
12. Ensure correct dosing of the cement quantity.
13. Ceramic capacitors with an AgPd external termination are not suited for the lead-free solder process: they were developed only for conductive adhesion technology.

This listing does not claim to be complete, but merely reflects the experience of EPCOS AG.

The following applies to all products named in this publication:

1. Some parts of this publication contain **statements about the suitability of our products for certain areas of application**. These statements are based on our knowledge of typical requirements that are often placed on our products in the areas of application concerned. We nevertheless expressly point out **that such statements cannot be regarded as binding statements about the suitability of our products for a particular customer application**. As a rule, EPCOS is either unfamiliar with individual customer applications or less familiar with them than the customers themselves. For these reasons, it is always ultimately incumbent on the customer to check and decide whether an EPCOS product with the properties described in the product specification is suitable for use in a particular customer application.
2. We also point out that **in individual cases, a malfunction of passive electronic components or failure before the end of their usual service life cannot be completely ruled out in the current state of the art, even if they are operated as specified**. In customer applications requiring a very high level of operational safety and especially in customer applications in which the malfunction or failure of a passive electronic component could endanger human life or health (e.g. in accident prevention or life-saving systems), it must therefore be ensured by means of suitable design of the customer application or other action taken by the customer (e.g. installation of protective circuitry or redundancy) that no injury or damage is sustained by third parties in the event of malfunction or failure of a passive electronic component.
3. **The warnings, cautions and product-specific notes must be observed.**
4. In order to satisfy certain technical requirements, **some of the products described in this publication may contain substances subject to restrictions in certain jurisdictions (e.g. because they are classed as “hazardous”)**. Useful information on this will be found in our Material Data Sheets on the Internet ([www.epcos.com/material](http://www.epcos.com/material)). Should you have any more detailed questions, please contact our sales offices.
5. We constantly strive to improve our products. Consequently, **the products described in this publication may change from time to time**. The same is true of the corresponding product specifications. Please check therefore to what extent product descriptions and specifications contained in this publication are still applicable before or when you place an order.  
We also **reserve the right to discontinue production and delivery of products**. Consequently, we cannot guarantee that all products named in this publication will always be available.
6. Unless otherwise agreed in individual contracts, **all orders are subject to the current version of the “General Terms of Delivery for Products and Services in the Electrical Industry” published by the German Electrical and Electronics Industry Association (ZVEI)**.
7. The trade names EPCOS, EPCOS-JONES, Baoke, CeraDiode, CSSP, MLSC, PhaseCap, PhaseMod, SIFERRIT, SIFI, SIKOREL, SilverCap, SIMID, SIOV, SIP5D, SIP5K, UltraCap, WindCap are **trademarks registered or pending** in Europe and in other countries. Further information will be found on the Internet at [www.epcos.com/trademarks](http://www.epcos.com/trademarks).