RHT *Climate* Transmitter

WM and DM models

INSTRUCTION MANUAL V1.2x B





Applies to devices with firmware version starting with V1.2x.



1	SAFETY ALERTS	3
2	INTRODUCTION	4
3	IDENTIFICATION	5
3.1	MODELS WITHOUT DISPLAY	5
3.2	MODELS WITH DISPLAY	5
3.3	DEVICE MODELS	6
4	DISPLAY INDICATIONS	7
4.1	HOME SCREEN	7
4.2	DISPLAYING MAXIMUM AND MINIMUM VALUES	7
4.3	DISPLAYING OTHER PSYCHROMETRIC PROPERTIES	7
4.4	SIGNALS	8
5	INSTALLATION	9
5.1	MECHANICAL INSTALLATION	9
5.1.1	DIMENSIONS	9
5.1.1.1	RHT <i>Climate</i> TRANSMITTER (WM MODEL)	9
5.1.1.2	RHT <i>Climate</i> TRANSMITTER (DM MODEL)	10
5.1.2	REMOVING AND INSTALLING THE FRONT COVER	10
5.2	ELECTRICAL INSTALLATION	11
5.2.1	RECOMMENDATIONS FOR INSTALLATION	11
5.2.2	SPECIAL PRECAUTION	11
5.2.3	ELECTRICAL CONNECTIONS	11
5.2.4	USB CONNECTION	11
5.3	SENSOR MAINTENANCE	11
5.3.1	PRECAUTIONS WITH SENSORS	11
5.3.2	SENSOR REPLACEMENT	12
6	PARAMETER CYCLES	13
7	CONFIGURATION	14
7.1	ANALOG OUTPUTS <i>Q11 / Q12</i>	14
7.2	ALARM OUTPUTS <i>RL11 / RL12</i>	15
7.3	BUZZER CONFIGURATION CYCLE	19
7.4	HMI CONFIGURATION CYCLE	21
7.5	DIAGNOSTIC CYCLE	23
7.6	COMMUNICATION CYCLE	24
7.7	GENERAL CONFIGURATION CYCLE	25
7.8	INFORMATION CYCLE	27
8	PARAMETERS MAP	28
9	USB INTERFACE	29
10	SERIAL COMMUNICATION	30
10.1	TABLE OF HOLDING REGISTER TYPE REGISTERS	30
11	NXPERIENCE SOFTWARE	36
11.1	INSTALLING NXPERIENCE	36
11.2	RUNNING NXPERIENCE	36
11.3	CONFIGURING THE DEVICE WITH NXPERIENCE	36
11.3.1	GENERAL PARAMETERS	38
11.3.2	INPUT PARAMETERS	38
11.3.3	OUTPUT PARAMETERS	39
11.3.4	HMI PARAMETERS	41
11.3.5	FINALIZATION PARAMETERS	43
11.4	DIAGNOSTICS	44
11.4.1	INPUT DIAGNOSTICS	44
11.4.2	OUTPUT DIAGNOSTICS	45
12	TECHNICAL SPECIFICATIONS	46
13	WARRANTY	48
14	APPENDIX I – NOTIONS ABOUT PSYCHROMETRY	49

1 SAFETY ALERTS

The symbols below are used in the device and throughout this manual to draw the user's attention to important information related to device safety and use.

		
CAUTION Read the manual fully before installing and operating the device.	CAUTION OR HAZARD Risk of electric shock.	ATTENTION Material sensitive to static charge. Check precautions before handling.

All safety recommendations appearing in this manual must be followed to ensure personal safety and prevent damage to the instrument or system. If the instrument is used in a manner other than that specified in this manual, the device's safety protections may not be effective.

2 INTRODUCTION

RHT *Climate* Transmitters Wall Mount (WM) and Duct Mount (DM) models incorporate high-precision, stable sensors for measuring temperature and relative humidity. Being microprocessed devices, they allow full configuration via USB or RS485 interface via a Modbus RTU command. **NXperience** allows the configuration of all the resources of the device, as well as the diagnosis of the analyzed information.

Apart from the **temperature** and **relative humidity** values, which are read directly from the sensor, the transmitter calculates the value of the following psychrometric properties¹:

- **Dew Point Temperature;**
- **Wet Bulb Temperature;**
- **Absolute Humidity;**
- **Frost Point Temperature;**
- **Specific Enthalpy;**
- **Partial Vapor Pressure;**
- **Mixture Ratio.**

Any variable read by the sensor or calculated by the device can be transmitted via one of the two available analog outputs. You are also allowed to configure the electrical operating level of each output:

- **0-10 V;**
- **4-20 mA.**

Two digital outputs with alarm or control functions can be related to any variable read or calculated by **RHT *Climate* Transmitter**.

The following options are also available:

- **RS485;**
- **Display with Backlight;**
- **Audible signal.**

It is important that you read carefully the manual before using this device and check that the versions of the manual and the device match. The firmware version number is displayed at the moment the device is powered on.

¹ Psychrometry is the study of thermodynamic properties of dry air and water vapor mixtures. Obtaining the psychrometric properties is crucial in the psychrometric processes of air conditioning, refrigeration, cooling and freezing, air humidification and dehumidification, drying and dehydration of humid devices, as well as in environmental and meteorological control.

3 IDENTIFICATION

3.1 MODELS WITHOUT DISPLAY

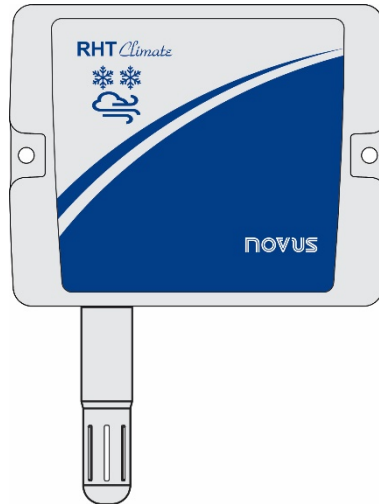

Fig. 01 – Device without display

3.2 MODELS WITH DISPLAY

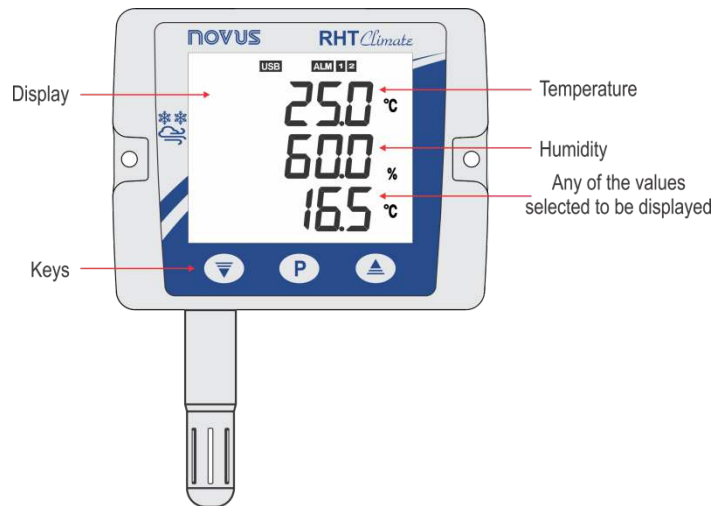

Fig. 02 – Device with display

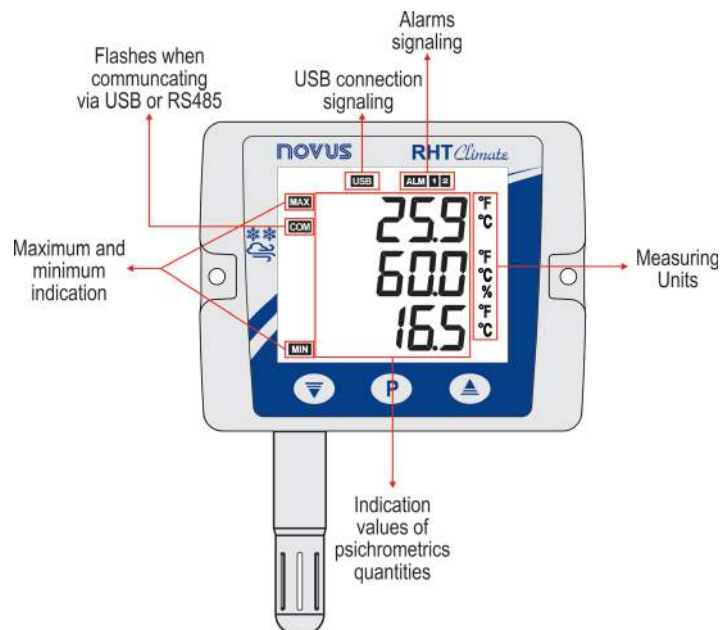





Fig. 03 – Display indications

Key  : Key used to advance the parameters and parameters cycles. A short touch advances parameters within a cycle. A long touch advances parameters cycles.

Key  : Key used to decrease parameters. A long touch when displaying the home screen performs the action linked to the second function of the key:

- None;
- Clears registered minimum and maximum values.

Key  : Key used to increase parameters. A long touch when displaying the home screen performs the action linked to the second function of the key:

- None;
- Mutes buzzer;
- Mutes buzzer and turns off the alarm outputs.

3.3 DEVICE MODELS

The RHT *Climate* Transmitter line is available in various device configurations to adapt perfectly to multiple market needs:

- **Wall Mount Model (WM)**: Recommended for wall mounting.
- **Duct Mount Model (DM)**: Recommended for duct mounting. DM models are available with a stainless steel (S) sensor probe and with lengths of 150 mm, 250 mm or 400 mm.

The table below shows all available models:

Model	RS485	Display	Stainless Steel Probe
RHT Climate-WM			
RHT Climate-WM-485-LCD	✓	✓	
RHT Climate-WM-485	✓		
RHT Climate-DM-150S			150 mm
RHT Climate-DM-150S-485	✓		150 mm
RHT Climate-DM-150S-485-LCD	✓	✓	150 mm
RHT Climate-DM-250S			250 mm
RHT Climate-DM-250S-485	✓		250 mm
RHT Climate-DM-250S-485-LCD	✓	✓	250 mm
RHT Climate-DM-400S			400 mm
RHT Climate-DM-400S-485	✓		400 mm
RHT Climate-DM-400S-485-LCD	✓	✓	400 mm

Table 01 – Available RHT *Climate* models

4 DISPLAY INDICATIONS

4.1 HOME SCREEN

The home screen displays three lines: line 1 displays the temperature read by the sensor, line 2 displays the value of relative humidity and finally line 3 displays the value of the option selected when configuring the device.

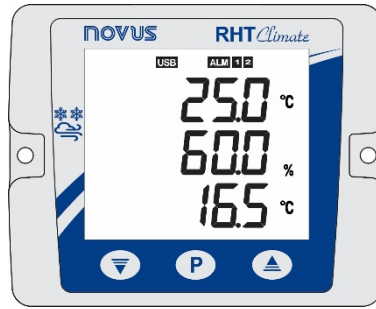

Fig. 04 - Home screen

4.2 DISPLAYING MAXIMUM AND MINIMUM VALUES

To navigate to the secondary screens, you need to press the key **P** with a short touch from the home screen. With each short touch of the key, the display will show the following screens:

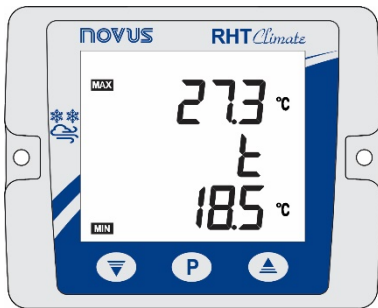

Fig. 05 - Maximum and minimum temperature

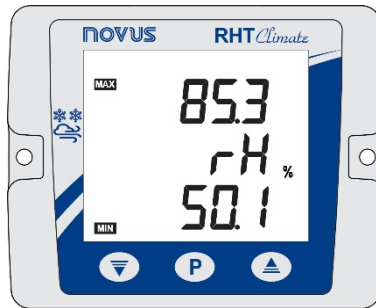

Fig. 06 - Maximum and minimum relative humidity

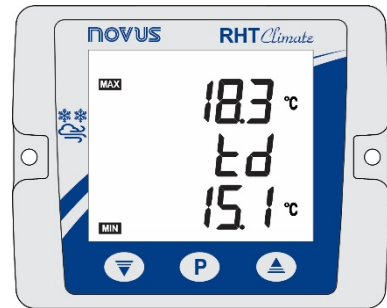

Fig. 07 - Maximum and minimum dew point temperature

On the central line, the display will show the name of the variable to which the maximum and minimum values refer:

- **t**: Temperature;
- **rH**: Relative humidity;
- **td**: Dew point.

On the upper line of the display is the **MAX** symbol, followed by the maximum value for that magnitude. On the lower line of the display is the **MIN** symbol, followed by the minimum value. If no key is pressed for 15 seconds, the display will return to the home screen.

4.3 DISPLAYING OTHER PSYCHROMETRIC PROPERTIES

After the screens of maximum and minimum values, are available screens for viewing other psychrometric variables. The device will advance one screen each short touch of the key **P**, respecting the following sequence:

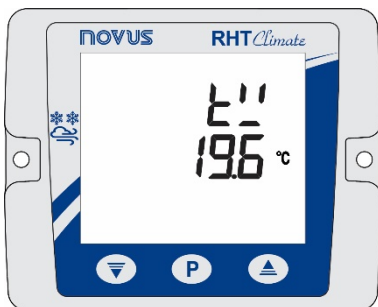

Fig. 08 - Wet bulb temperature

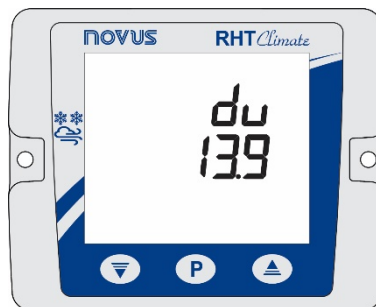

Fig. 09 - Absolute humidity

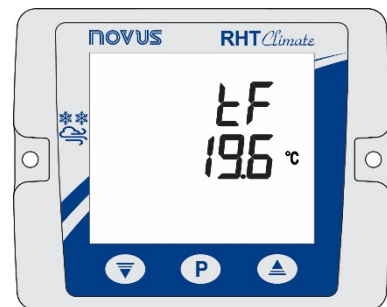

Fig. 10 - Frost point temperature

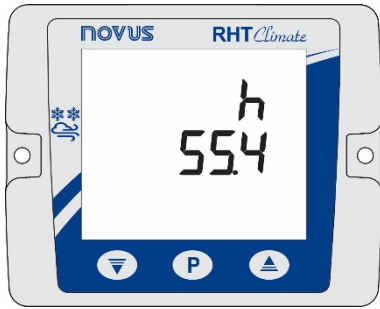

Fig. 11 - Specific enthalpy

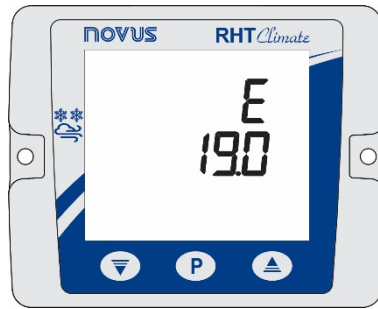

Fig. 12 - Partial vapor pressure

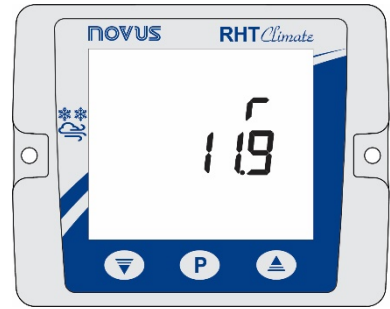

Fig. 13 - Mixture ratio

4.4 SIGNALS

- + : Indicates that the alarm 1 output is in alarm condition.
- + **flashing**: Indicates that the alarm 1 output is in alarm condition, but the output is disabled due to overcurrent protection.
- + : Indicates that the alarm 2 output is in alarm condition.
- + **flashing**: Indicates that the alarm 2 output is in alarm condition, but the output is disabled due to overcurrent protection.
- **BUZZER**: The buzzer may be activated in three conditions:
 - BUZZER output alarm;
 - ALM1 output alarm if the buzzer is enabled in alarm 1 configurations;
 - ALM2 output alarm if the buzzer is enabled in alarm 2 configurations.
- : Indicates that the device is connected to a USB port.
- **flashing**: Indicates that the device is responding to a data request or command.
- **nnnn**: Indicates that the value to be displayed on one of the lines is above the display limit.
- **uuuu**: Indicates that the value to be shown on one of the lines is below the display limit

5.1 MECHANICAL INSTALLATION

The RHT *Climate* Transmitter WM model was designed to be secured to a wall by two mounting holes on the transmitter, as shown in Fig. 14. Mounting should follow the sequence of steps below:

- Use the device’s perforation template to mark the position of transmitter mounting bore holes;
- Make the two holes using a drill with bit number 6. The bore holes should be deeper than the size of bushings;
- Insert bushings in holes. Bushings should be completely inserted into the wall;
- Position the transmitter on the wall, aiming to align with the perforations, and use bolts to secure it to the wall.

	<p>Bolts and bushings do not come with the device.</p> <p>The device should be mounted with the sensor capsule facing downward to ensure the specified precision and protection rating.</p>
---	--

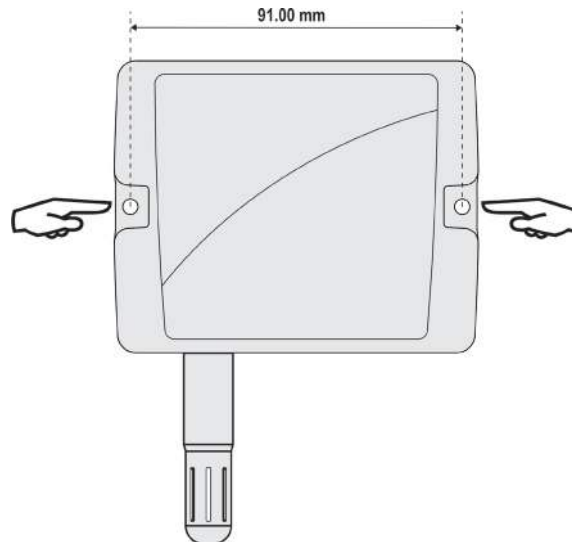

Fig. 14 – Mechanical Installation

The RHT *Climate* Transmitter DM model it is mounted via a flange. First the flange is mounted on the duct wall, then the transmitter rod is inserted into the central bore hole on the flange and secured.

5.1.1 DIMENSIONS

5.1.1.1 RHT *Climate* TRANSMITTER (WM MODEL)

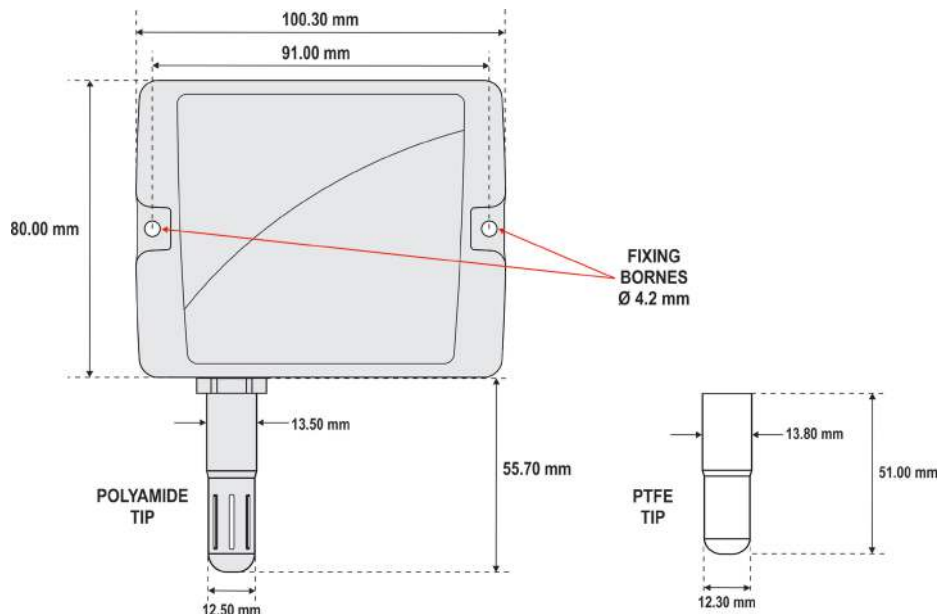

Fig. 15 – Dimensions of WM model

5.1.1.2 RHT *Climate* TRANSMITTER (DM MODEL)

Fig. 16 shows the flange dimensions and perforation:

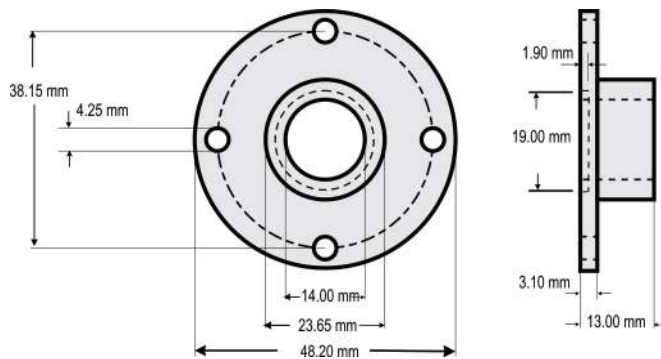

Fig. 16 - Flange for mounting DM model

The rods for these models are made of stainless steel, with lengths of 150, 250 or 400 mm.

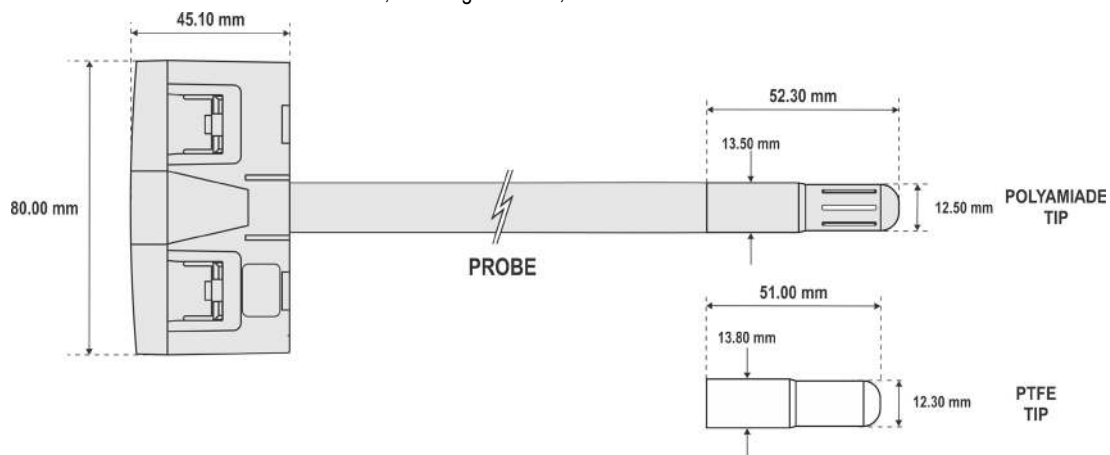

Fig. 17 – Dimensions of DM model

5.1.2 REMOVING AND INSTALLING THE FRONT COVER

To remove the front cover, insert a screwdriver. It is necessary to fit in the lateral handles and to force it lightly until realizing its release. The procedure should be repeated on each of the side handles of the device, as shown in the figures below. With all sides clear, the cover can be easily removed:

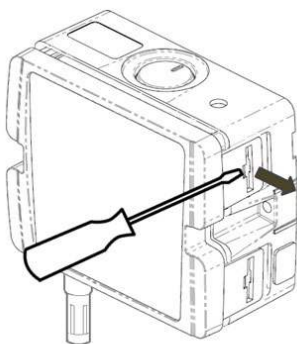

Fig. 18 - Removing the front cover of the transmitter

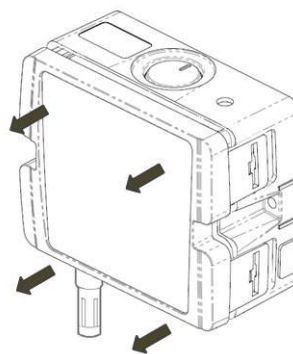

Fig. 19 - Removing the front cover of the transmitter

To install, fit the cover onto the base by pressing it with care to fully secure the transmitter, as shown in the figure below:

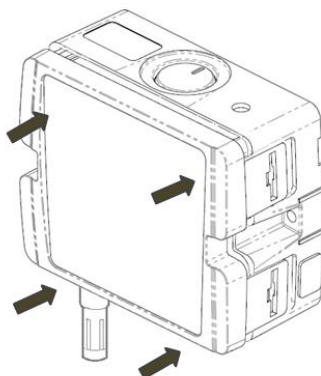

Fig. 20 - Device cover fitting

5.2 ELECTRICAL INSTALLATION

5.2.1 RECOMMENDATIONS FOR INSTALLATION

- Signal conductors should run through the plant separately from the power supply and output conductors, if possible in grounded conduits.
- The power supply for electronic instruments must come from an appropriate grid for instruments.
- RC FILTERS (noise suppressor) are recommended in contactor coils, solenoids, etc.
- In control applications, it's essential to consider what could happen when some part of the system fails. The device's internal devices do not ensure total protection.
- Grounding helps limit the effects of noise due to electromagnetic interference (EMI). Run the grounding connection by using the grounding bolt and the grounding plane before turning on the device.

5.2.2 SPECIAL PRECAUTION

Because the transmitter is an electronic module, it requires some care when handling:

- When opening the transmitter to connect electrical wiring, avoid contact with the electronic circuit due to the risk of damage caused by static electricity.
- Pay close attention when connecting wires.
- Remember to pass all wires through a cable clip before completing electrical connections.
- When closing the housing, the cover should be placed again properly, ensuring proper sealing for this model.



5.2.3 ELECTRICAL CONNECTIONS

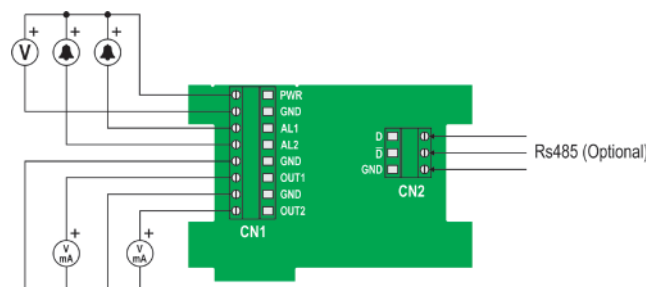

Fig. 21 – RHT *Climate* electrical connections

* Connector CN2 is only mounted on models that have RS485 interface (Optional).

5.2.4 USB CONNECTION

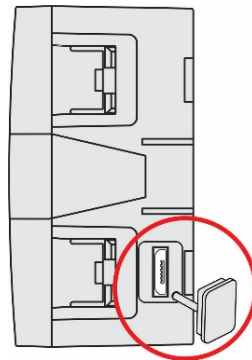

Fig. 22 – USB cable connection

5.3 SENSOR MAINTENANCE

5.3.1 PRECAUTIONS WITH SENSORS



The sensor used in the RHT *Climate* Transmitter is a device that is sensitive to electrostatic discharge (ESD). Whenever the sensor is touched, measures need to be taken to prevent ESD damage.

The sensor may be damaged or lose its calibration if exposed to atmospheres contaminated with chemical agents. Hydrochloric Acid, Nitric Acid, Sulfuric Acid and Ammonia at high concentrations can damage the sensor. Acetone, Ethanol and Propylene Glycol can cause reversible measurement errors.

The humidity sensor's calibration can be altered if it is exposed to contaminating vapors or extreme humidity and temperature conditions for prolonged periods. To speed up calibration restore, proceed as described below:

- Carefully remove the sensor from the capsule, avoiding contact with bare hands (it must be removed with the use of plastic tweezers or clean antistatic gloves);
- If there are solid particles on the sensor, wash it with deionized water at room temperature;
- Place the sensor in an oven at 120 °C (+/-10 °C) for 6 hours;
- Carefully replace the sensor in the capsule.

It is also possible to clean or dry the sensor using filtered and oil-free air, taking care that the air jets do not mechanically damage the sensor.

5.3.2 SENSOR REPLACEMENT

In case of damage, the humidity and temperature sensor may need to be replaced. To perform this procedure, follow the steps below:

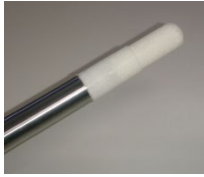

- **Step 1:** Disconnect the transmitter from the power supply and remove the USB cable if it is connected. Locate the sensor's protective tip.

This example shows the sensor replacement of an **RHT Climate DM Transmitter**. In it, the sensor is located at the end of the rod.

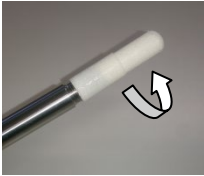

- **Step 2:** Remove the tip by turning it counterclockwise.

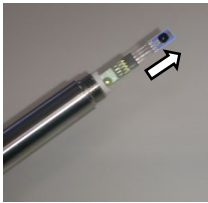

- **Step 3:** Without the tip the sensor will be exposed. Remove it by pulling it forward to disconnect it.

- **Step 4:** Connect the new sensor to the rod tip connector with the aid of plastic tweezers or clean antistatic gloves, avoiding pushing or engaging the sensor by hand only.

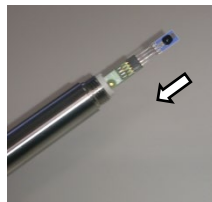

	<p>Hold the sensor only by its terminals, using plastic tweezers or new gloves.</p>
	<p>Do not hold the sensor by the sensor element. Do not use metal tweezers. Do not touch the sensor without wearing gloves.</p>



- **Step 5:** Place the protection tip again and turn it clockwise to secure it to the device.

6 PARAMETER CYCLES

The configuration parameters are clustered in affinity groups, called parameter cycles. The 10 parameter cycles are:

CYCLE	ACCESS
1 - Primary Cycle: In this cycle are the screens for viewing the psychrometric variables.	Unrestricted access
2 - Out 1 Cycle: In this cycle are the configuration parameters of the transmission 1 output.	Enables the protection mode of these cycles
3 - Out 2 Cycle: In this cycle are the configuration parameters of the transmission 2 output.	
4 - ALN 1 Cycle: In this cycle are the configuration parameters of the alarm 1 output.	
5 - ALN 2 Cycle: In this cycle are the configuration parameters of the alarm 2 output.	
6 - buz 2 Cycle: In this cycle are the configuration parameters of the buzzer.	
7 - HMI Cycle: In this cycle are the HMI configuration parameters.	
8 - d iRG Cycle: In this cycle are the parameters for forcing values of temperature, relative humidity and transmission outputs, alarm and buzzer.	
9 - COM Cycle: In this cycle you can configure parameters related to RS485 Modbus communication.	
10 - CFG Cycle: You must enter the device password to access the parameters in this cycle. The parameters allow the selection of the measurement units, the adjustment of the atmospheric pressure, besides the offsets and the digital filters for the sensor readings. You also can enable the protection of the configuration parameters and change the password.	
11 - Information Cycle: In this cycle are displayed the serial number (Sn) and the firmware version (F irn) of the device.	

Table 02 – Parameter cycles

7 CONFIGURATION

The RHT *Climate Transmitter* has a set of parameters that allows the configuration of its two transmission outputs and its two alarm outputs and can assigning the psychrometric properties below to each of them. The properties can be expressed in the International System of Measures (SI) or in the English System of Measures (US).

Psychrometric properties		SI			US		
		Min.	Max.	Unit	Min.	Max.	Unit
Temperature (measured value)	t	-40	100	°C	-40	212	°F
Relative humidity (measured value)	rH	0	100	% RH	0	100	% RH
Dew point temperature (calculated value)	t_d	-90	100	°C	-130	212	°F
Wet bulb temperature (calculated value)	t_w	-40	100	°C	-40	212	°F
Absolute humidity (calculated value)	du	0	600	g/m ³	0	262	gr/ft ³
Frost point temperature (calculated value)	t_F	-90	100	°C	-130	212	°F
Specific enthalpy (calculated value)	h	-40	700000*	kJ/kg	-18	300945*	BTU/lb
Partial vapor pressure (calculated value)	E	0	1035	mbar	0	15	psi
Mixture ratio (calculated value)	r	0	260000*	g/kg	0	1820000*	gr/lb

Temperature and relative humidity are the only variables that are measured directly from the sensor that comes with the device. All other measurements are obtained via algorithms that can lead to slight variations in relation to the real values.

Table 03 – Psychrometric properties

7.1 ANALOG OUTPUTS $Out1$ / $Out2$

The configuration cycle for analog outputs 1 and 2 allows you to assign:

- The psychrometric property associated with the output;
- The default electrical output;
- The value to be shown in case of error in the sensor reading;
- The excursion range of the transmitted psychrometric property.

Note: When the lower limit is defined with a value higher than the higher limit, the output current operates from 20-4 mA to 10-0 V.

7.1.1 Psychrometric property to be transmitted by analog outputs $Out1$ / $Out2$

It allows you to configure the psychrometric property to be transmitted by the analog outputs $Out1$ / $Out2$.

	Psychrometric property to be transmitted	Default: oFF
	$Out1$ <i>NEAS</i>	Outputs $Out1$ / $Out2$ off
Temperature		t
Relative humidity		rH
Dew point temperature		t_d
Wet bulb temperature		t_w
$Out2$ <i>NEAS</i>	Absolute humidity	du
	Frost point temperature	t_F
	Specific enthalpy	h
	Partial vapor pressure	E
	Mixture ratio	r

Table 04 – Psychrometric property to be transmitted

7.1.2 Operating mode for analog outputs $Out1$ / $Out2$

It allows you to configure the type of electric signal to be used by the analog outputs $Out1$ / $Out2$.

	Type of signal from analog outputs $Out1$ / $Out2$	Default: 4-20
	$Out1$ <i>ModE</i>	Analog output 1 operating in mode 4-20 mA
$Out2$ <i>ModE</i>	Analog output 1 operating in mode 0-10 V	0-10

Table 05 – Type of signal from analog outputs

7.1.3 Lower limit of the transmission range from analog outputs $Out1$ / $Out2$

It allows you to configure the lower background scale for analog outputs $Out1$ / $Out2$.

		SI				US			
Lower limit of the transmission range from analog outputs $Out1$ / $Out2$		Min.	Max.	Unit	Default	Min.	Max.	Unit	Default
$Out1$ L-Lo	Temperature t	-40	100	°C	-40	-40	212	°F	-40
	Relative humidity rH	0	100	% RH	0	0	100	% RH	0
	Dew point temperature t_d	-90	100	°C	-90	-130	212	°F	-130
	Wet bulb temperature t_w	-40	100	°C	-40	-40	212	°F	-40
$Out2$ L-Lo	Absolute humidity dU	0	600	g/m ³	0	0	262	gr/ft ³	0
	Frost point temperature t_F	-90	100	°C	-90	-130	212	°F	-130
	Specific enthalpy h	-40	700000*	kJ/kg	-40	-18	300945*	BTU/lb	-18
	Partial vapor pressure E	0	1035	mbar	0	0	15	psi	0
	Mixture ratio r	0	260000*	g/kg	0	0	1820000*	gr/lb	0

Table 06 – Lower limit of the transmission range from analog outputs

* These values extrapolate the maximum value that can be shown by the display. Using the HMI, you can set up to the limit of 19999. When configured via **NXperience**, these parameters can be adjusted up to the values shown on the table above, but when accessing these parameters via the HMI, they will display the value **0000**.

7.1.4 Upper limit of the transmission range from analog outputs $Out1$ / $Out2$

It allows you to configure the upper background scale for analog outputs $Out1$ / $Out2$.

		SI				US			
Upper limit of the transmission range from analog outputs $Out1$ / $Out2$		Min.	Max.	Unit	Default	Min.	Max.	Unit	Default
$Out1$ L-H _i	Temperature	-40	100	°C	100	-40	212	°F	212
	Relative humidity	0	100	% RH	100	0	100	% RH	100
	Dew point temperature	-90	100	°C	100	-130	212	°F	212
	Wet bulb temperature	-40	100	°C	100	-40	212	°F	212
$Out2$ L-H _i	Absolute humidity	0	600	g/m ³	600	0	262	gr/ft ³	262
	Frost point temperature	-90	100	°C	100	-130	212	°F	212
	Specific enthalpy	-40	700000*	kJ/kg	700000*	-18	300945*	BTU/lb	300945*
	Partial vapor pressure	0	1035	mbar	1035	0	15	psi	15
	Mixture ratio	0	260000*	g/kg	260000*	0	1820000*	gr/lb	1820000*

Table 07 – Upper limit of the transmission range from analog outputs

* These values extrapolate the maximum value that can be shown by the display. Using the HMI, you can set up to the limit of 19999. When configured via **NXperience**, these parameters can be adjusted up to the values shown on the table above, but when accessing these parameters via the HMI, they will display the value **0000**.

7.1.5 Status of analog outputs $Out1$ / $Out2$ in case of sensor error

It allows you to configure the status of analog outputs $Out1$ / $Out2$ in case of error in the sensor reading.

$Out1$ Err	Value of analog outputs $Out1$ / $Out2$ in case of error	Default: L _o
	Sets analog outputs $Out1$ / $Out2$ to the minimum value in case of error in the sensor reading.	L _o
$Out2$ Err	Sets the analog outputs $Out1$ / $Out2$ to the maximum value in case of error in the sensor reading.	H _i

Table 08 – Value of analog outputs $Out1$ / $Out2$ in case of error

7.2 ALARM OUTPUTS $ALN1$ / $ALN2$

All models of **RHT Climate Transmitters** have two alarm outputs, which can also be used with ON/OFF control outputs. For models with display, there is the additional feature of an internal buzzer for audible signaling. For each alarm output and for the buzzer, the following can be configured:

- The associated psychrometric property;
- Alarm type L_o, H_i, L-H_i, -L-H_i;
- The setpoints;
- Hysteresis;
- Output condition in case of sensor error;
- And the timing.

The configuration cycle for alarms **ALN1 / ALN2** allows for assigning the psychrometric property associated with alarm outputs **ALN1 / ALN2**, the operating mode for alarms **ALN1 / ALN2** (type of alarm), activation points for alarms **ALN1 / ALN2**, their timing values, inhibition of alarm condition when turning the device on, and the alarm activation mode in case of sensor reading error.

The figure below shows how the alarm outputs are activated and deactivated according to the type of alarm selected.

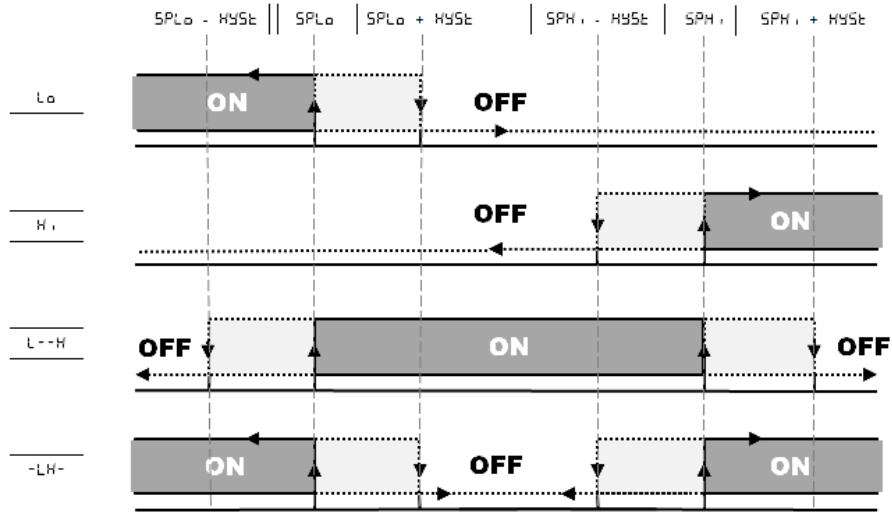

Fig. 23 - Alarm output activation and deactivation

The RHT *Climate* Transmitter allows for four timing options for its alarm outputs and for the buzzer:

- Normal operation;
- Activation for set time;
- Delay in activation;
- Intermittent activation.

The figures in **Table 4** show the behavior of alarm outputs with these activation variations defined by the t_{ON} and t_{OFF} time intervals.

OPERATION	t_{ON}	t_{OFF}	ACTUATION
Normal operation	0	0	Alarm Output is ON immediately after Alarm Event.
Activation with set time	1 to 6500 s	0	Alarm Output is ON after a delay of t_{ON} following Alarm Event.
Delayed activation	0	1 to 6500 s	Alarm Output is ON immediately after Alarm Event, but remains ON for a duration of t_{OFF} .
Intermittent activation	1 to 6500 s	1 to 6500 s	Alarm Output is ON for t_{ON} , OFF for t_{OFF} , and ON again for t_{ON} after Alarm Event.

Table 09 - Timing functions for alarms

The **Initial Blocking** option prevents alarm activation if there is an alarm condition when the controller is turned on. The alarm is only enabled after the process passes through a non-alarm condition.

The initial block is useful, for example, when one of the alarms is configured as minimum value alarm, potentially setting off the alarm right when the process is started up, which is often undesirable behavior.

Initial blocking is not valid for the Sensor Open function.

7.2.1 Psychrometric property associated with alarms *ALN1 / ALN2*

It allows you to configure a psychrometric property that will be associated with alarms *ALN1 / ALN2*.

Psychrometric property associated with alarms <i>ALN1 / ALN2</i>		Default: <i>t</i>
<i>ALN1</i> <i>NEAS</i>	Temperature	<i>t</i>
	Relative humidity	<i>rH</i>
	Dew point temperature	<i>td</i>
	Wet bulb temperature	<i>t'</i>
<i>ALN2</i> <i>NEAS</i>	Absolute humidity	<i>dU</i>
	Frost point temperature	<i>tF</i>
	Specific enthalpy	<i>h</i>
	Partial vapor pressure	<i>E</i>
	Mixture ratio	<i>r</i>

Table 10 – Psychrometric property associated with alarms *ALN1 / ALN2*

7.2.2 Activation mode for alarms *ALN1 / ALN2*

It allows you to turn off alarms *ALN1 / ALN2* or configure them to operate as one of the alarm types indicated below:

Activation mode for alarm outputs <i>ALN1 / ALN2</i>		Default: <i>oFF</i>
<i>ALN1</i> <i>Node</i>	Off	<i>oFF</i>
	Sets off alarm in case of sensor error	<i>iErr</i>
	Sets off alarm below setpoint <i>SPLo</i>	<i>Lo</i>
<i>ALN2</i> <i>Node</i>	Sets off alarm above setpoint <i>SPHi</i>	<i>Hi</i>
	Sets off alarm between <i>SPLo</i> and <i>SPHi</i>	<i>L--H</i>
	Sets off alarm below <i>SPLo</i> and above <i>SPHi</i>	<i>-LH-</i>

Table 11 – Activation mode for alarm outputs *ALN1 / ALN2*

7.2.3 Lower Setpoint for activating alarms *ALN1 / ALN2*

It allows you to configure the set point for alarm types *Lo*, *L--H* and *-LH-*.

		SI				US			
Setpoint lower than alarm outputs <i>ALN1 / ALN2</i>		Min.	Max.	Unit	Default	Min.	Max.	Unit	Default
<i>ALN1</i> <i>SPLo</i>	<i>ALN1 / ALN2</i> for temperature	-40	100	°C	-40	-40	212	°F	-40
	<i>ALN1 / ALN2</i> for relative humidity	0	100	% RH	0	0	100	% RH	0
	<i>ALN1 / ALN2</i> for dew point temperature	-90	100	°C	-90	-130	212	°F	-130
	<i>ALN1 / ALN2</i> for wet bulb temperature	-40	100	°C	-40	-40	212	°F	-40
<i>ALN2</i> <i>SPLo</i>	<i>ALN1 / ALN2</i> for absolute humidity	0	600	g/m³	0	0	262	gr/ft³	0
	<i>ALN1 / ALN2</i> for frost point temperature	-90	100	°C	-90	-130	212	°F	-130
	<i>ALN1 / ALN2</i> for specific enthalpy	-40	700000*	kJ/kg	-40	-18	300945*	BTU/lb	-18
	<i>ALN1 / ALN2</i> for partial vapor pressure	0	1035	Mbar	0	0	15	psi	0
<i>ALN1 / ALN2</i> for mixture ratio	0	260000*	g/kg	0	0	1820000*	gr/lb	0	

Table 12 – Setpoint lower than alarm outputs *ALN1 / ALN2*

* These values extrapolate the maximum value that can be shown by the display. Using the HMI, you can set up to the limit of 19999. When configured via **NXperience**, these parameters can be adjusted up to the values shown on the table above, but when accessing these parameters via the HMI, they will display the value **9999**.

7.2.4 Higher Setpoint for activating alarms *ALN1 / ALN2*

It allows you to configure the setpoint for alarm types *H*, *L--H* and *-LH-*.

		SI				US			
Setpoint higher than alarm outputs <i>ALN1 / ALN2</i>		Min.	Max.	Unit	Default	Min.	Max.	Unit	Default
<i>ALN1</i> <i>SPH1</i>	<i>ALN1 / ALN2</i> for temperature	-40	100	°C	100	-40	212	°F	212
	<i>ALN1 / ALN2</i> for relative humidity	0	100	% RH	100	0	100	% RH	100
	<i>ALN1 / ALN2</i> for dew point temperature	-90	100	°C	100	-130	212	°F	212
	<i>ALN1 / ALN2</i> for wet bulb temperature	-40	100	°C	100	-40	212	°F	212
<i>ALN2</i> <i>SPH1</i>	<i>ALN1 / ALN2</i> for absolute humidity	0	600	g/m ³	600	0	262	gr/ft ³	262
	<i>ALN1 / ALN2</i> for frost point temperature	-90	100	°C	100	-130	212	°F	212
	<i>ALN1 / ALN2</i> for specific enthalpy	-40	700000*	kJ/kg	700000*	-18	300945*	BTU/lb	300945*
	<i>ALN1 / ALN2</i> for partial vapor pressure	0	1035	mbar	1035	0	15	psi	15
	<i>ALN1 / ALN2</i> for mixture ratio	0	260000*	g/kg	260000*	0	1820000*	gr/lb	1820000*

Table 13 – Setpoint higher than alarm outputs *ALN1 / ALN2*

* These values extrapolate the maximum value that can be shown by the display. Using the HMI, you can set up to the limit of 19999. When configured via *NXperience*, these parameters can be adjusted up to the values shown on the table above, but when accessing these parameters via the HMI, they will display the value *nnnnn*.

7.2.5 Hysteresis for turning off alarms *ALN1 / ALN2*

It allows you to adjust the differential for turning off alarms *ALN1 / ALN2*.

		SI				US			
Output hysteresis of alarms <i>ALN1 / ALN2</i>		Min.	Max.	Unit	Default	Min.	Max.	Unit	Default
<i>ALN1</i> <i>HYS1</i>	<i>ALN1 / ALN2</i> for temperature	0	20	°C	0	0	20	°F	0
	<i>ALN1 / ALN2</i> for relative humidity	0	20	% RH	0	0	20	% RH	0
	<i>ALN1 / ALN2</i> for dew point temperature	0	20	°C	0	0	20	°F	0
	<i>ALN1 / ALN2</i> for wet bulb temperature	0	20	°C	0	0	20	°F	0
<i>ALN2</i> <i>HYS1</i>	<i>ALN1 / ALN2</i> for absolute humidity	0	20	g/m ³	0	0	20	gr/ft ³	0
	<i>ALN1 / ALN2</i> for frost point temperature	0	20	°C	0	0	20	°F	0
	<i>ALN1 / ALN2</i> for specific enthalpy	0	20	kJ/kg	0	0	20	BTU/lb	0
	<i>ALN1 / ALN2</i> for partial vapor pressure	0	20	mbar	0	0	20	psi	0
	<i>ALN1 / ALN2</i> for mixture ratio	0	20	g/kg	0	0	20	gr/lb	0

Table 14 – Output hysteresis of alarms *ALN1 / ALN2*

7.2.6 Alarms *ALN1 / ALN2* on time

		Min.	Max.	Unit	Default
<i>ALN1</i> <i>EO1</i>	Time of alarms on	0	6500	s	0
<i>ALN2</i> <i>EO1</i>					

Table 15 – Time of alarms on

7.2.7 Alarms *ALN1 / ALN2* off time

		Min.	Max.	Unit	Default
<i>ALN1</i> <i>EOFF</i>	Time of alarms off	0	6500	s	0
<i>ALN2</i> <i>EOFF</i>					

Table 16 – Time of alarms off

7.2.8 Initial blocking of alarms *ALN1 / ALN2*

It allows blocking the activation of alarms *ALN1 / ALN2* if the transmitter starts up in alarm condition.

<i>ALN1</i> <i>bLA</i>	Initial blocking of alarms <i>ALN1 / ALN2</i>	Default: YES
	Without initial blocking of alarms <i>ALN1 / ALN2</i>	no
<i>ALN2</i> <i>bLA</i>	With initial blocking of alarms <i>ALN1 / ALN2</i>	YES

Table 17 – Initial blocking of alarms *ALN1 / ALN2*

7.2.9 Status of alarms *ALN1 / ALN2* in case of sensor error

It allows you to configure the outputs from alarms *ALN1 / ALN2* so that they are activated in case of sensor reading error.

<i>ALN1</i> <i>Err</i>	Status of alarm outputs <i>ALN1 / ALN2</i> in case of sensor error	Default: oFF
	Alarms <i>ALN1 / ALN2</i> off	oFF
<i>ALN2</i> <i>Err</i>	Alarms <i>ALN1 / ALN2</i> on	on

Table 18 – Status of alarm outputs *ALN1 / ALN2* in case of sensor error

7.2.10 Enable buzzer activation linked to alarms *ALN1 / ALN2*

It allows you to enable buzzer activation linked to alarms *ALN1 / ALN2*.

<i>ALN1</i> <i>bu22</i>	Enable buzzer for alarm outputs <i>ALN1 / ALN2</i>	Default: d5bL
	The buzzer will not be activated when alarms <i>ALN1 / ALN2</i> occur.	d5bL
<i>ALN2</i> <i>bu22</i>	The buzzer will be activated when alarms <i>ALN1 / ALN2</i> occur.	EnbL

Table 19 – Enable buzzer for alarm outputs *ALN1 / ALN2*

7.3 BUZZER CONFIGURATION CYCLE

The buzzer configuration cycle allows for assigning the psychrometric property associated with the buzzer, the buzzer operating mode (type of alarm), buzzer activation points, their timing values, inhibition of alarm condition when turning the device on, and the buzzer activation mode in case of sensor reading error.

7.3.1 Psychrometric property associated with the buzzer

It allows you to configure the psychrometric property that will be associated with the buzzer.

<i>bu22</i> <i>NEAS</i>	Psychrometric property associated with the buzzer	Default: t
	Temperature	t
	Relative humidity	rH
	Dew point temperature	td
	Wet bulb temperature	t_w
	Absolute humidity	dU
	Frost point temperature	t_F
	Specific enthalpy	h
	Partial vapor pressure	E
	Mixture ratio	r

Table 20 – Psychrometric property associated with the buzzer

7.3.2 Buzzer activation mode

It allows you to turn off the buzzer or configure it to operate as one of the alarm types set forth below:

<i>bu22</i> <i>ModE</i>	Buzzer activation mode	Default: oFF
	Off	oFF
	Activates the alarm in case of sensor error	!Err
	Activates alarm below setpoint SPLo	L_o
	Activates alarm above setpoint SPHi	H_i
	Activates alarm between SPLo and SPHi	L--H
Activates alarm below SPLo and above SPHi	-LH-	

Table 21 – Buzzer activation mode

7.3.3 Lower psychrometric property setpoint for buzzer activation

It allows you to configure the setpoint for alarm types **L_o**, **L--H** and **-LH-**.

		SI				US			
bu22 SPLo	Psychrometric property	Min.	Max.	Unit	Default	Min.	Max.	Unit	Default
	Temperature	-40	100	°C	-40	-40	212	°F	-40
	Relative humidity	0	100	% RH	0	0	100	% RH	0
	Dew point temperature	-90	100	°C	-90	-130	212	°F	-130
	Wet bulb temperature	-40	100	°C	-40	-40	212	°F	-40
	Absolute humidity	0	600	g/m ³	0	0	262	gr/ft ³	0
	Frost point temperature	-90	100	°C	-90	-130	212	°F	-130
	Specific enthalpy	-40	700000*	kJ/kg	-40	-18	300945*	BTU/lb	-18
	Partial vapor pressure	0	1035	mbar	0	0	15	psi	0
	Mixture ratio	0	260000*	g/kg	0	0	1820000*	gr/lb	0

Table 22 – Psychrometric property

* These values extrapolate the maximum value that can be shown by the display. Using the HMI, you can set up to the limit of 19999. When configured via **NXperience**, these parameters can be adjusted up to the values shown on the table above, but when accessing these parameters via the HMI, they will display the value **9999**.

7.3.4 Higher Setpoint for buzzer activation

It allows you to configure the set point for alarm types **H_i**, **L--H** and **-LH-**.

		SI				US			
bu22 SPH _i	Higher Setpoint for buzzer activation	Min.	Max.	Unit	Default	Min.	Max.	Unit	Default
	Temperature	-40	100	°C	100	-40	212	°F	212
	Relative humidity	0	100	% RH	100	0	100	% RH	100
	Dew point temperature	-90	100	°C	100	-130	212	°F	212
	Wet bulb temperature	-40	100	°C	100	-40	212	°F	212
	Absolute humidity	0	600	g/m ³	600	0	262	gr/ft ³	262
	Frost point temperature	-90	100	°C	100	-130	212	°F	212
	Specific enthalpy	-40	700000*	kJ/kg	700000*	-18	300945*	BTU/lb	300945*
	Partial vapor pressure	0	1035	mbar	1035	0	15	psi	15
	Mixture ratio	0	260000*	g/kg	260000*	0	1820000*	gr/lb	1820000*

Table 23 – Higher Setpoint for buzzer activation

* These values extrapolate the maximum value that can be shown by the display. Using the HMI, you can set up to the limit of 19999. When configured via **NXperience**, these parameters can be adjusted up to the values shown on the table above, but when accessing these parameters via the HMI, they will display the value **9999**.

7.3.5 Hysteresis for turning off buzzer

It allows you to adjust the differential for turning off the buzzer.

		SI				US			
bu22 HYS _t	Hysteresis for turning off buzzer	Min.	Max.	Unit	Default	Min.	Max.	Unit	Default
	Temperature	0	20	°C	0	0	20	°F	0
	Relative humidity	0	20	% RH	0	0	20	% RH	0
	Dew point temperature	0	20	°C	0	0	20	°F	0
	Wet bulb temperature	0	20	°C	0	0	20	°F	0
	Absolute humidity	0	20	g/m ³	0	0	20	gr/ft ³	0
	Frost point temperature	0	20	°C	0	0	20	°F	0
	Specific enthalpy	0	20	kJ/kg	0	0	20	BTU/lb	0
	Partial vapor pressure	0	20	mbar	0	0	20	psi	0
	Mixture ratio	0	20	g/kg	0	0	20	gr/lb	0

Table 24 – Hysteresis for turning off buzzer

7.3.6 Buzzer on time

Min.	Max.	Unit	Default
------	------	------	---------

bu22 tOn	Buzzer on time	0	6500	s	0
---------------------------	----------------	----------	-------------	---	----------

Table 25 – Buzzer on time

7.3.7 Buzzer off time

		Min.	Max.	Unit	Default
bu22 tOFF	Buzzer off time	0	6500	s	0

Table 26 – Buzzer off time

7.3.8 Initial buzzer blocking

It allows blocking buzzer activation if the transmitter starts up in alarm condition.

bu22 bLR	Initial buzzer blocking	Default: YES
	Without initial buzzer blocking	no
	With initial buzzer blocking	YES

Table 27 – Initial buzzer blocking

7.3.9 Buzzer status in case of sensor error

It allows you to configure the buzzer output so that it is activated in case of sensor reading error.

bu22 Err	Buzzer status in case of sensor error	Default: OFF
	Buzzer off	OFF
	Buzzer on	on

Table 28 – Buzzer status in case of sensor error

7.4 HMI CONFIGURATION CYCLE

The HMI configuration cycle allows for adjusting contrast, display backlight operating mode and functions of increase and decrease keys.

7.4.1 Backlight

It adjusts the display backlight operating mode.

hmi bclt	Backlight	Default: on
	Off	OFF
	Always on	on
	On for 15 seconds after pressing any key	PrSS

Table 29 – Backlight

7.4.2 Contrast

It adjusts the display contrast. Depending on the preferred viewing angle, the contrast may need to be adjusted to improve the clarity of information on the display.

hmi cont	Contrast	Default: on
	Contrast 1 (-40° in relation to the horizontal line)	1
	Contrast 2 (-20° in relation to the horizontal line)	2
	Contrast 3 (0° in relation to the horizontal line)	3
	Contrast 4 (+20° in relation to the horizontal line)	4
	Contrast 5 (+40° in relation to the horizontal line)	5

Table 30 – Contrast

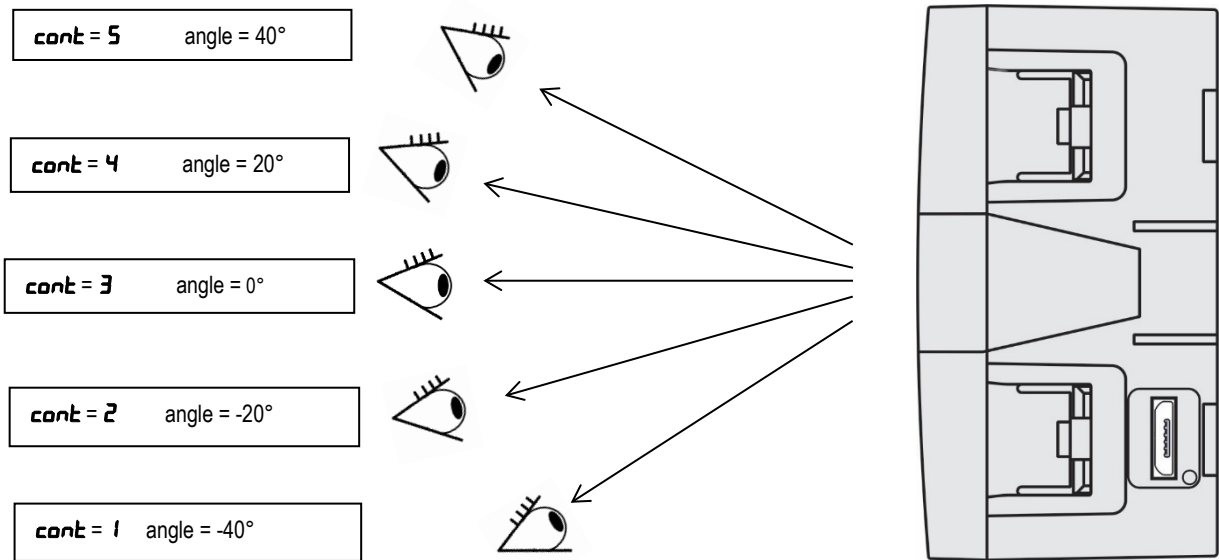

Fig. 24 – RHT *Climate* Transmitter display contrast

7.4.3 Second function of key

It allows you to configure the second function of the increase key.

IHN F1	Second function of the increase key	Default: nonE
	None	nonE
	Mutes buzzer	b2
	Mutes buzzer and turns off alarm output	b2AL

Table 31 – Second function of the increase key

7.4.4 Second function of key

It allows you to configure the second function of the decrease key.

IHN F2	Second function of the decrease key	Default: nonE
	None	nonE
	Clear maximum and minimum values	clr

Table 32 – Second function of the decrease key

7.4.5 Configuring the third line of the display

It allows you to configure the information to be displayed on the third line of the display.

IHN Ln3	Third line of the display	Default: td
	Dew point	td
	Wet bulb temperature	t'!
	Absolute humidity	du
	Frost point	tF
	Specific enthalpy	h
	Partial vapor pressure	E
	Mixture ratio	r
	None	oFF

Table 33 – Third line of the display

7.5 DIAGNOSTIC CYCLE

The diagnostic cycle lets you test the operation of the **RHT Climate Transmitter**, making sure that all of its peripherals are working properly.

7.5.1 Analog output **FoU1** / **FoU2** forcing

It allows you to force a current or voltage value at the analog output **OUT1** / **OUT2**. If the output is configured as output at voltage 0-10 V, you can adjust the value between 0.00 V and 10.00 V. If the output is configured as an output at current 4-20 mA, you can adjust the value between 4.00 mA and 20.00 mA (to check the operating range for the output in current). Above 20.0 mA, you will be able to adjust the output to 21.0 mA, to simulate the transmission failure signal. The same thing happens for the lower limit, which may shift to 3.6 mA.

The figure below shows the normal transmission range limits and the transmission failure signal zones.

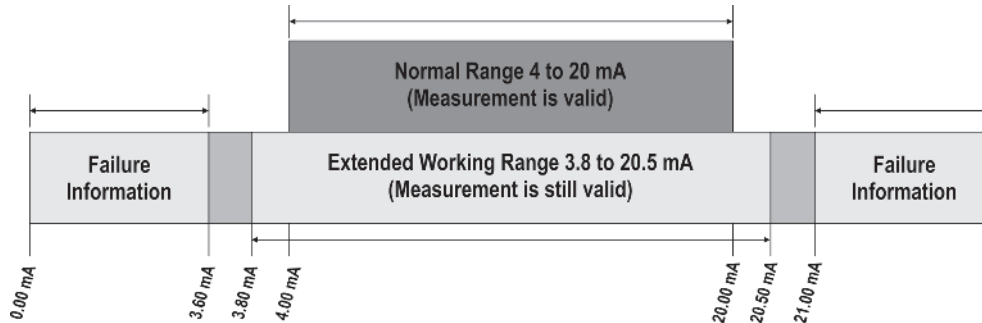

Fig. 25 – Normal transmission range limits

		Min.	Max.	Unit	Default
d.AG FoU1	Forces voltage value at analog output 1. (If Out1 / Out2 Node = 0-10)	0	10.00	V	0
d.AG FoU2	Forces current value at analog output 1. (If Out1 / Out2 Node = 4-20)	3.6	21.00	mA	4

Table 34 – Analog output **FoU1** / **FoU2** forcing

7.5.2 Temperature reading forcing

It allows you to force a temperature value. This feature can be used to simulate temperature alarms or alarms for other variables due to change.

		SI				US			
		Min.	Max.	Unit	Default	Min.	Max.	Unit	Default
d.AG F.t	Forces the temperature reading value.	-40	100	°C	-40	-40	212	°F	-40

Table 35 – Temperature reading forcing

7.5.3 Relative humidity reading forcing

It allows you to force a relative humidity value. This feature can be used to simulate relative humidity alarms or alarms for other variables due to change. If, for example, alarm output 1 is configured to activate whenever relative humidity is higher than 80% RH or lower than 40 % RH, you can evidence the **ALN1** output operating as the forced value varies.

		Min.	Max.	Unit	Default
d.AG F.rH	Forces relative humidity reading value.	0	100	%	0

Table 36 – Relative humidity reading forcing

7.5.4 Alarm **ALN1** / **ALN2** output forcing

It allows you to force activation of alarm output **ALN1** / **ALN2**.

d.AG FA1	Forces alarm output ALN1 / ALN2	Default: oFF
d.AG FA1	Forces alarm ALN1 / ALN2 off output	oFF
d.AG FA1	Forces alarm ALN1 / ALN2 on output	on

Table 37 – Forces alarm output **ALN1** / **ALN2**

7.5.5 Buzzer forcing

It allows you to force buzzer activation.

d.AG Fb22	Forces buzzer output	Default: oFF
d.AG Fb22	Forces buzzer off output	oFF
d.AG Fb22	Forces buzzer on output	on

Table 38 – Buzzer forcing

7.6 COMMUNICATION CYCLE

In the communication cycle, you will find configuration parameters for the RS485 Modbus serial port: Baud rate, parity and address.

7.6.1 Baud Rate

The **RHT Transmitter** can be access via a Modbus-RTU network. The baud rate, parity and device address on the network need to be configured for this. The device responds to the read and write commands in its internal registers according to the specifications set out in this manual (see chapter on SERIAL COMMUNICATION).

CFG baud	Baud Rate	19.2
	1200 bps	1.2
	2400 bps	2.4
	4800 bps	4.8
	9600 bps	9.6
	19200 bps	19.2
	38400 bps	38.4
	57600 bps	57.6
	115200 bps	115.2

Table 39 – Baud rate

7.6.2 Parity

This parameter configures the parity for **RHT Climate Transmitter** communication on a Modbus-RTU network.

CFG Prty	Parity	Default: nonE
	Without parity	nonE
	Even Parity	EuEn
	Odd Parity	odd

Table 40 – Parity

7.6.3 Address

This parameter configures the address for **RHT Climate Transmitter** communication on a Modbus-RTU network. This parameter should be adjusted so that no two devices use the same address within a Modbus-RTU network.

CFG Raddr	Internet address	Min.	Max.	Unit	Default
		1	247	-	1

Table 41 – Address

7.7 GENERAL CONFIGURATION CYCLE

To access the parameters in this cycle, you must enter with the device password. The parameters in this cycle allow for selecting units of measure, adjusting atmospheric pressure, as well as offsets and digital filters for the sensor readings. Also in this cycle, you can enable configuration parameter protection and change the password.

7.7.1 Unit of Measure

The RHT *Climate* Transmitter can operate using the standard measurements in the International System of Measures (SI) or the English System of Measures (US). The table below shows the measurement unit adopted for each psychrometric property according to the value configured in this parameter.

CFG Unit	Units of measure		Default: SI
	International System of Measures		SI
	English System of Measures		US

	SI	US
Temperature	°C	°F
Relative humidity	% RH	% RH
Dew point temperature	°C	°F
Partial vapor pressure	mbar	psi
Wet bulb temperature	°C	°F
Absolute humidity	g/m ³	gr/ft ³
Mixture ratio	g/kg	gr/lb
Specific enthalpy	kJ/kg	BTU/lb
Frost point temperature	°C	°F

Table 42 – Units of measure

7.7.2 Atmospheric Pressure

The RHT *Climate* Transmitter uses the atmospheric pressure value to calculate some psychrometric properties. The default value used by this device is 1013 mbar (14.7 psi), but you can refine this information by inserting the value read by another reference instrument. Atmospheric pressure may vary according to altitude, or due to conditions of the process itself.

CFG PrES	Configures the atmospheric pressure value. This value is used for the calculation of psychrometric properties.	SI				US			
		Min.	Max.	Unit	Default	Min.	Max.	Unit	Default
		0	10000	mbar	1013	0	145	psi	14.7

Table 43 – Atmospheric pressure

7.7.3 Digital temperature reading filter

A digital filter can be inserted at the temperature value read by the sensor, to reduce undesirable variations. The higher the time value configured in the digital filter, the slower the temperature reading response will be.

CFG FLt	Temperature sensor reading filter	Min.	Max.	Unit	Default
		0	300	s	60

Table 44 – Digital temperature reading filter

7.7.4 Digital relative humidity reading filter

A digital filter can be inserted at the relative humidity value read by the sensor, to reduce undesirable variations. The higher the time value configured in the digital filter, the slower the relative humidity reading response will be.

CFG FLrH	Humidity sensor reading filter	Min.	Max.	Unit	Default
		0	300	s	0

Table 45 – Digital relative humidity reading filter

7.7.5 Temperature reading offset

This parameter allows for correcting offset displacement in the temperature reading.

CFG OFt	Temperature reading offset	SI				US			
		Min.	Max.	Unit	Default	Min.	Max.	Unit	Default
		-5	5	°C	0	-9	9	°F	0

Table 46 – Temperature reading offset

7.7.6 Relative humidity reading offset

This parameter allows for correcting offset displacement in the relative humidity reading.

		Min.	Max.	Unit	Default
CFG DFrH	Humidity reading offset	-5	5	%	0

Table 47 – Relative humidity reading offset

7.7.7 Password

The RHT *Climate* Transmitter can be protected with a password, which ensures greater protection for the parameters defined in the device. This feature prevents unauthorized people from making changes to the transmitter's operating mode.

The configured factory default password is "1111". To change the password, you must enter the master password, which is formed as follows:

Master password = 9 followed by the last three digits forming the serial number.
--

After entering the master password, you can insert a new password.

		Min.	Max.	Unit	Default
CFG PASS	Password	0	9999	-	1111

Table 48 – Password

7.7.8 Parameter Protection

This parameter allows for enabling and disabling the protection of other parameters. When parameter protection is enabled, the RHT *Climate* Transmitter will allow for viewing the parameters, but will not allow any change to the configured values. The device leaves the factor with parameter protection disabled.

CFG Prot	Parameter protection	Default: dSbL
	Parameter protection disabled	dSbL
	Parameter protection enabled	EnbL

Table 49 – Parameter protection

After configuring the transmitter, you can access this parameter and select the **EnbL** option to enable protection. As of this moment, the protection will be enabled.

To disable protection, you should access the **PASS** parameter and enter the configured password. Next you should access the **Prot** parameter and select the **dSbL** option. As of this moment, the protection will be disabled.

If the protection is enabled and you attempt to alter any parameter, the transmitter will show the **Prot** message on the display instead of the defined value.

7.8 INFORMATION CYCLE

In the information cycle, the RHT *Climate* Transmitter displays the serial number (**S_n**) and firmware version (**F_{ir}**n****) of the device.



Fig. 26 - Serial number and firmware version information

8 PARAMETERS MAP

PRIMARY CYCLE	<i>Out1</i>	<i>Out2</i>	<i>ALN1</i>	<i>ALN2</i>	<i>bu22</i>	<i>IHN</i>	<i>d.rG</i>	<i>CO n</i>	<i>CnFG</i>	
Temperature Relative humidity Selected variable	<i>NEAS</i>	<i>NEAS</i>	<i>NEAS</i>	<i>NEAS</i>	<i>NEAS</i>	<i>bcLt</i>	<i>FOu1</i>	<i>bAud</i>	<i>PRSS</i>	<i>Sn</i>
Maximum temperature Minimum temperature	<i>NodE</i>	<i>NodE</i>	<i>NodE</i>	<i>NodE</i>	<i>NodE</i>	<i>Cont</i>	<i>FOu2</i>	<i>Prty</i>	<i>Un it</i>	<i>F irn</i>
Maximum relative humidity Minimum relative humidity	<i>L-Lo</i>	<i>L-Lo</i>	<i>SPLo</i>	<i>SPLo</i>	<i>SPLo</i>	<i>F1</i>	<i>F lt</i>	<i>Addr</i>	<i>PrES</i>	
Maximum dew point Minimum dew point	<i>L-H, </i>	<i>L-H, </i>	<i>SPH, </i>	<i>SPH, </i>	<i>SPH, </i>	<i>F2</i>	<i>F lrH</i>		<i>FLt</i>	
Wet bulb temperature	<i>Err</i>	<i>Err</i>	<i>HYSlt</i>	<i>HYSlt</i>	<i>HYSlt</i>	<i>Scrn Ln3</i>	<i>FAL1</i>		<i>FLrH</i>	
Absolute humidity			<i>tOn</i>	<i>tOn</i>	<i>tOn</i>		<i>FAL2</i>		<i>DFt</i>	
Frost point temp.			<i>tOFF</i>	<i>tOFF</i>	<i>tOFF</i>		<i>Fb22</i>		<i>DFrH</i>	
Enthalpy			<i>bLA</i>	<i>bLA</i>	<i>bLA</i>				<i>PRSS</i>	
Partial vapor pressure			<i>Err</i>	<i>Err</i>	<i>Err</i>				<i>Prot</i>	
Mixture ratio			<i>bu22</i>	<i>bu22</i>						

Table 50 – Device parameters map



9 USB INTERFACE

The USB interface is used for CONFIGURING or MONITORING the device. For CONFIGURATION, the **NXperience** software should be used, which offers features for creating, viewing, saving and opening configurations from the device or from files on your computer. The feature for saving and opening configurations in files makes it possible to transfer configurations between device and make backup copies. For specific models, **NXperience** also allows for updating the controller's firmware (internal software) via USB interface.

For MONITORING, any supervision (SCADA) or laboratory software may be used that offers support for Modbus RTU communication over a serial communication port. When connected to a computer USB port, **TEMP Climate Transmitter** is recognized as a conventional serial port (COM x). Use **NXperience** or refer to the Device Manager on Windows Control Panel to identify the COM port that was assigned to the transmitter. Refer to the Modbus memory mapping in the device's communication manual and its supervision software documentation to perform MONITORING.

Follow the procedure below to use the device's USB communication:

- Download **NXperience** from our website and install it on your computer (see chapter NXPERIENCE SOFTWARE). The USB drivers required for communication will be installed along with the software.
- Connect the USB cable between the device and the computer. The controller doesn't need a power supply. The USB will provide enough power for the communication operation (other device functions may not operate).
- Launch **NXperience**, configure communication and start device recognition.

	<p>The USB interface IS NOT ISOLATED from the retransmission outputs and alarm outputs. Its purpose is temporary use during CONFIGURATION and MONITORING periods. For the safety of people and device, it should only be used with the device fully disconnected from the external power supply inlet. USB use in any other connection condition is possible, but it requires careful analysis by the person in charge of installation. For MONITORING for long periods and with inputs and outputs connected, use of the RS485 interface is recommended, available or optional in most of our devices.</p>
	

10 SERIAL COMMUNICATION

The RHT *Climate* Transmitter can be recognized on an RS485 network with MODBUS RTU protocol as a slave device. All of the controller's configurable parameters can be read and/or written via serial communication. Writing to Registers in broadcast mode is also allowed, using address 0.

The available Modbus commands are as follows:

03 – Read Holding Register

05 – Write Single Coil

06 – Write Single Register

16 – Write Multiple Registers

10.1 TABLE OF HOLDING REGISTER TYPE REGISTERS

			SI			US		
PRIMARY CYCLE INDICATION REGISTERS								
Address	Description	R/W	Min.	Max.	Default	Min.	Max.	Default
0	Relative humidity value	RO	0	10000	-	0	10000	-
1								
2	Dry bulb temperature value	RO	-4000	10000	-	-4000	21200	-
3								
4	Wet bulb temperature value	RO	-4000	10000	-	-4000	21200	-
5								
6	Dew point value	RO	-9000	10000	-	-13000	21200	-
7								
8	Frost point value	RO	-9000	10000	-	-13000	21200	-
9								
10	Specific enthalpy value	RO	-4000	70000000*	-	-1800	30094500*	-
11								
12	Absolute humidity value	RO	0	60000	-	0	26200	-
13								
14	Partial vapor pressure value	RO	0	103500	-	0	1500	-
15								
16	Mixture ratio value	RO	0	26000000*	-	0	182000000*	-
17								
18	Minimum humidity value	RO	0	1000	-	0	1000	-
19								
20	Maximum humidity value	RO	0	1000	-	0	1000	-
21								
22	Minimum temperature value	RO	-4000	1000	-	-4000	2120	-
23								
24	Maximum temperature value	RO	-4000	1000	-	-4000	2120	-
25								
26	Minimum dew point value	RO	-9000	1000	-	-13000	2120	-
27								
28	Maximum dew point value	RO	-9000	1000	-	-13000	2120	-
29								

Table 51 – Primary cycle indication registers

* For firmware version less than or equal to 1.10, the maximum enthalpy value is 32767 and the maximum mix ratio value is 65535.

ANALOG OUTPUT OUT1 TRANSMISSION REGISTERS								
Address	Description	R/W	Min.	Max.	Default	Min.	Max.	Default
101	Transmission output type	RW	0	1	0	0	1	0
102	Variable that will be transmitted	RW	0	9	0	0	9	0
103	Upper retransmission limit input	RW	The limits depend on the psychrometric property configured at address 102.					
104								
105	Lower retransmission limit input	RW	The limits depend on the psychrometric property configured at address 102.					
106								
107	Value in case of error	RW	0	1	1	0	1	1
108	Upper retransmission limit	RO	The limits depend on the psychrometric property configured at address 102.					
109								
110	Lower retransmission limit	RO	The limits depend on the psychrometric property configured at address 102.					
111								

Table 52 – Analog Output OUT1 Transmission Registers

ANALOG OUTPUT OUT2 TRANSMISSION REGISTERS								
Address	Description	R/W	Min.	Max.	Default	Min.	Max.	Default
113	Retransmission output type	RW	0	1	0	0	1	0
114	Variable that will be transmitted	RW	0	9	0	0	9	0
115	Upper retransmission limit input	RW	The limits depend on the psychrometric property configured at address 114.					
116								
117	Lower retransmission limit input	RW	The limits depend on the psychrometric property configured at address 114.					
118								
119	Value in case of error	RW	0	1	0	0	1	0
	Upper retransmission limit	RO	The limits depend on the psychrometric property configured at address 114.					
	Lower retransmission limit	RO	The limits depend on the psychrometric property configured at address 114.					

Table 53 – Analog Output OUT2 Transmission Registers

FILTER AND UNIT SYSTEM REGISTERS								
Address	Description	R/W	Min.	Max.	Default	Min.	Max.	Default
125	Filter for humidity reading	RW	0	300	60	0	300	60
126	Filter for temperature reading	RW	0	300	60	0	300	60
127	Configuring units	RW	0	1	0	0	1	0

Table 54 – Filter and Unit System Registers

ALARM ALM1 OUTPUT REGISTERS								
Address	Description	R/W	Min.	Max.	Default	Min.	Max.	Default
133	Variable that will set off alarm	RW	1	9	1	1	9	1
134	Type of alarm	RW	0	5	0	0	5	0
135	High Setpoint input for alarm	RW	The limits depend on the psychrometric property configured at address 133.					
136								
137	Low Setpoint input for alarm	RW	The limits depend on the psychrometric property configured at address 133.					
138								
139	Alarm blocking	RW	0	1	1	0	1	1
140	Alarm hysteresis	RW	0	200	0	0	200	0
141	Alarm ON time	RW	0	6500	0	0	6500	0
142	Alarm OFF time	RW	0	6500	0	0	6500	0
143	Determines the alarm status in case of sensor error	RW	0	1	0	0	1	0

144	Determines buzzer activation	RW	0	1	0	0	1	0
145	Setpoint High Alarm	RO	The limits depend on the psychrometric property configured at address 133.					
146								
147	Setpoint Low Alarm	RO	The limits depend on the psychrometric property configured at address 133.					
148								

Table 55 – Alarm ALM1 Output Registers

ALARM ALM2 OUTPUT REGISTERS								
Address	Description	R/W	Min.	Max.	Default	Min.	Max.	Default
150	Variable that will set off alarm	RW	1	9	1	1	9	1
151	Type of alarm	RW	0	5	0	0	5	0
152	Alarm Setpoint High Input	RW	The limits depend on the psychrometric property configured at address 150.					
153								
154	Alarm Setpoint Low Input	RW	The limits depend on the psychrometric property configured at address 150.					
155								
156	Alarm blocking	RW	0	1	1	0	1	1
157	Alarm hysteresis	RW	0	200	0	0	200	0
158	Alarm ON time	RW	0	6500	0	0	6500	0
159	Alarm OFF time	RW	0	6500	0	0	6500	0
160	Determines the alarm status in case of sensor error	RW	0	1	0	0	1	0
161	Determines buzzer activation	RW	0	1	0	0	1	0
162	Alarm Setpoint High	RO	The limits depend on the psychrometric property configured at address 150.					
163								
164	Alarm Setpoint Low	RO	The limits depend on the psychrometric property configured at address 150.					
165								

Table 56 – Alarm ALM2 Output Registers

ALARM ALM3 OUTPUT REGISTERS								
Address	Description	R/W	Min.	Max.	Default	Min.	Max.	Default
167	Variable that will set off alarm	RW	1	9	1	1	9	1
168	Type of alarm	RW	0	5	0	0	5	0
169	Alarm Setpoint High Input	RW	The limits depend on the psychrometric property configured at address 167.					
170								
171	Alarm Setpoint Low Input	RW	The limits depend on the psychrometric property configured at address 167.					
172								
173	Alarm blocking	RW	0	1	1	0	1	1
174	Alarm hysteresis	RW	0	200	0	0	200	0
175	Alarm ON time	RW	0	6500	0	0	6500	0
176	Alarm OFF time	RW	0	6500	0	0	6500	0
177	Determines the alarm status in case of sensor error	RW	0	1	0	0	1	0
178	Determines buzzer activation	RW	0	1	0	0	1	0
179	Alarm Setpoint High	RO	The limits depend on the psychrometric property configured at address 167.					
180								
181	Alarm Setpoint Low	RO	The limits depend on the psychrometric property configured at address 167.					
182								

Table 57 – Alarm ALM3 Output Registers

RS485 MODBUS COMMUNICATION PORT CONFIGURATION REGISTERS								
Address	Description	R/W	Min.	Max.	Default	Min.	Max.	Default
184	Baud rate	RW	0	7	4	0	7	4
185	Parity	RW	0	2	0	0	2	0
186	Slave address	RW	1	247	1	1	247	1
187	Defines the variable of the third line of the HMI	RW	0	7	0	0	7	0

Table 58 – RS485 Modbus Communication Port Configuration Registers

OFFSET REGISTERS								
Address	Description	R/W	Min.	Max.	Default	Min.	Max.	Default
192	Temperature Offset	RW	-50	50	0	-90	90	0
193	Humidity Offset	RW	-50	50	0	-50	50	0
200	Pressure value used for calculations	RW	0	10000	1013	0	10000	147

Table 59 – Offset Registers

FORCING REGISTERS								
Address	Description	R/W	Min.	Max.	Default	Min.	Max.	Default
201	Enables output 1 forcing	RW	0	1	0	0	1	0
202	Forced value for output 1	RW	Limits depend on the analog output 1 configuration.					
203	Enables output 2 forcing	RW	0	1	0	0	1	0
204	Forced value for output 2	RW	Limits depend on the analog output 2 configuration.					
205	Enables forcing of alarm 1	RW	0	1	0	0	1	0
206	Changes alarm status	RW	0	1	0	0	1	0
207	Enables forcing of alarm 2	RW	0	1	0	0	1	0
208	Changes alarm status	RW	0	1	0	0	1	0
209	Turning backlight on	RW	0	2	1	0	2	1
211	Enables buzzing forcing	RW	0	1	0	0	1	0
212	Buzzer activation	RW	0	1	0	0	1	0
213	Enables humidity forcing	RW	0	1	0	0	1	0
214	Forced humidity value	RW	0	1000	0	0	1000	0
215	Enables temperature forcing	RW	0	1	0	0	1	0
216	Forced temperature value	RW	-400	1000	0	-400	2120	0

Table 60 – Forcing Registers



MINIMUM AND MAXIMUM PSYCHROMETRIC PROPERTIES AND SECOND KEY FUNCTION RESET REGISTERS								
Address	Description	R/W	Min.	Max.	Default	Min.	Max.	Default
217	Reset of all min. and max. values	RW	0	1	0	0	1	0
221	Second function of key 	RW	0	2	0	0	2	0
222	Second function of key 	RW	0	1	0	0	1	0

Table 61 – Minimum and Maximum Psychrometric Properties and Second Key Function Reset Registers

DEVICE TAG REGISTERS								
Address	Description	R/W	Min.					
224	Device name string	RW	ASCII	CHARACTER 2		CHARACTER 1		
225		RW	ASCII	CHARACTER 4		CHARACTER 3		
226		RW	ASCII	CHARACTER 6		CHARACTER 5		
227		RW	ASCII	CHARACTER 8		CHARACTER 7		
228		RW	ASCII	CHARACTER 10		CHARACTER 9		
229		RW	ASCII	CHARACTER 12		CHARACTER 11		
230		RW	ASCII	CHARACTER 14		CHARACTER 13		

231		RW	ASCII	CHARACTER 16	CHARACTER 15
232		RW	ASCII	CHARACTER 18	CHARACTER 17
233		RW	ASCII	CHARACTER 20	CHARACTER 19

Table 62 – Device Tag Registers

SENSOR LINEARIZATION REGISTERS								
Address	Description	R/W	Min.	Max.	Default	Min.	Max.	Default
234	Enables temperature linearization	RW	0	1	0	0	1	0
235	Real temperature value 1	RW	-400	1000	0	-400	2120	0
236	Target temperature value 1	RW	-400	1000	0	-400	2120	0
237	Real temperature value 2	RW	-400	1000	0	-400	2120	0
238	Target temperature value 2	RW	-400	1000	0	-400	2120	0
239	Real temperature value 3	RW	-400	1000	0	-400	2120	0
240	Target temperature value 3	RW	-400	1000	0	-400	2120	0
241	Real temperature value 4	RW	-400	1000	0	-400	2120	0
242	Target temperature value 4	RW	-400	1000	0	-400	2120	0
243	Real temperature value 5	RW	-400	1000	0	-400	2120	0
244	Target temperature value 5	RW	-400	1000	0	-400	2120	0
245	Enables humidity linearization	RW	0	1	0	0	1	0
246	Real humidity value 1	RW	0	1000	0	0	1000	0
247	Target humidity value 1	RW	0	1000	0	0	1000	0
248	Real humidity value 2	RW	0	1000	0	0	1000	0
249	Target humidity value 2	RW	0	1000	0	0	1000	0
250	Real humidity value 3	RW	0	1000	0	0	1000	0
251	Target humidity value 3	RW	0	1000	0	0	1000	0
252	Real humidity value 4	RW	0	1000	0	0	1000	0
253	Target humidity value 4	RW	0	1000	0	0	1000	0
254	Real humidity value 5	RW	0	1000	0	0	1000	0
255	Target humidity value 5	RW	0	1000	0	0	1000	0

Table 63 – Sensor Linearization Registers

DEVICE INFORMATION REGISTERS		
Address	Description	R/W
300	High serial number	RO
301	Low serial number	RO
302	Firmware version	RO
303	Release version	RO
304	ID	RO
305	Informs the device model	RO

Table 64 – Device Information Registers

DIAGNOSTIC REGISTERS		
Address	bit	Description
341	0	-
	1	Analog output 1 in overload.
	2	Analog output 2 in overload.
	3	Alarm 1 output status.
	4	Alarm 2 output status.
	5	Alarm 1 condition status.
	6	Alarm 2 condition status.
	7	Buzzer status in alarm 1.
	8	Buzzer status in alarm 2.
	9	Buzzer status.
	10	Alarm 1 forcing status.
	11	Alarm 2 forcing status.
	12	Analog output 1 forcing status.
	13	Analog output 2 forcing status.
342	0	Sensor error.
	1	Error in water vapor saturation pressure.
	2	Error in water vapor pressure.
	3	Error at dew point.
	4	Error in absolute humidity.
	5	Error in mixture ratio.
	6	-
	7	-
	8	Error in wet bulb temperature.
	9	Error in specific enthalpy.
	10	-
	11	Error in frost point.
343	1	Input values for retransmission limits of output 1 out of range.
	2	Input values for retransmission limits of output 2 out of range.
	3	Input values for alarm 1 setpoints out of range.
	4	Input values for alarm 2 setpoints out of range.
	5	Input values for alarm 3 setpoints out of range.

Table 65 – Diagnostic Registers

The registers 103 to 106, 115 to 118, 135 to 138, 152 to 155 and 169 to 172 shall be used to enter the values of their respective parameters. If they are within limits, the device will automatically pass these values to registers 108 to 111, 120 to 123, 145 to 148, 162 to 165 and 179 to 182, which show the values considered during the operation. If the limits were extrapolated, this condition will be signaled in the diagnostic register 343. For 32-bit data, the two registers that compose them must be read and/or written in order for the values to be updated.

11 NXPERIENCE SOFTWARE

The **NXperience** software is the main tool for configuring, downloading and analyzing data for **RHT Climate Transmitter**. It allows you to explore all the features and functionality of the device, communicating through the USB interface.

This manual describes the generic features of the software. For more specific instructions on device configuration and tool operation, check the specific operation manual. The software and its respective manual can be downloaded from our website www.novus.com.br in the Download Area.

11.1 INSTALLING NXPERIENCE

To install **NXperience**, you must execute the **NXperienceSetup.exe** file, available on our website.

11.2 RUNNING NXPERIENCE

When you open **NXperience** software, the home screen will be displayed:

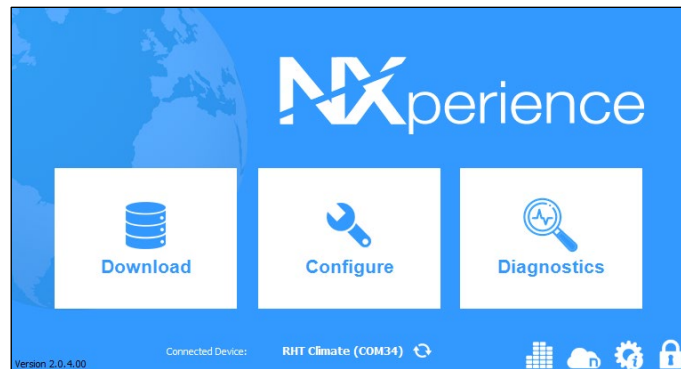

Fig. 27 – NXperience Home Screen

To communicate with the software, the **RHT Climate Transmitter** must be connected to the computer and with the USB drivers previously installed.

Then you can click on **Configure** or **Diagnostics**. The **Download** option is not available for this device model.

To read a device, you must select it. To do so, simply double-click on the desired device and click the **Ok** button. This device will be adopted as the default for the next time the software performs the communication process.

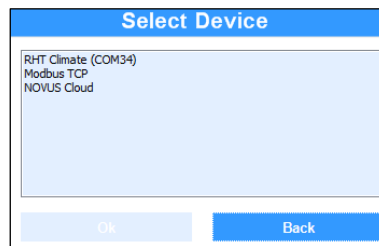

Fig. 28 – Select Device screen

11.3 CONFIGURING THE DEVICE WITH NXPERIENCE

For the device configuration, it must be connected to the computer's USB port.

When you click the **Configure** button, the following screen will be displayed:

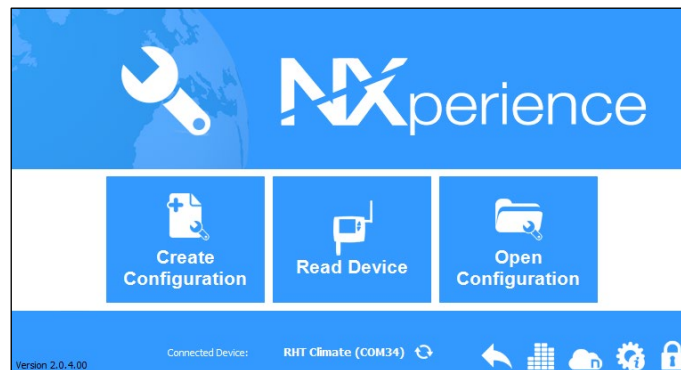

Fig. 29 – Device configuration screen

The **Create Configuration** button creates a configuration from scratch. The device does not need to be plugged into the computer's USB port. This configuration can be saved in a file for future use, or saved to a connected device.

The **Open Configuration** button is used for reading from an already created configuration file.

The **Read Device** button reads the current device configuration. By selecting this option, all features available for configuration will be displayed, as shown in the figure below:

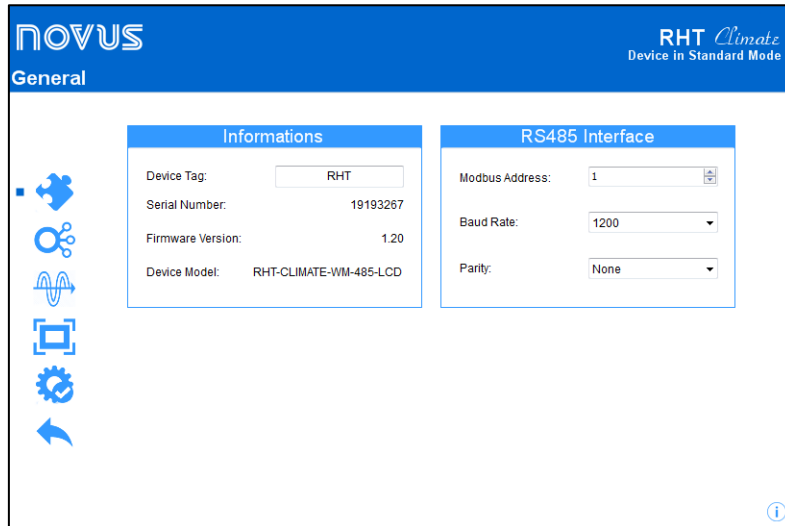

Fig. 30 – Configuration Screen



General: In this tab, you can assign an identification name to the device and configure the RS-485 interface parameters. It is also possible to identify the model, serial number and firmware version of the device.



Input: In this tab, you can select the system of measures to be used by the device. It is also possible to configure the offset and digital filter for the temperature and relative humidity sensor input and perform linearization.



Output: In this tab, you can configure the two transmission analog outputs, the two alarm outputs and the buzzer.



HMI: In this tab, you can configure the information and parameters that will be available on the device display. It is also possible to configure the backlight, the display contrast, the additional function of the navigation keys and the value to be displayed on the third line of the HMI.

* The HMI features are only available for models with LCD display.



Finalization: In this tab, you can send the configuration to the device, save the configuration in a file, update the device firmware, and configure a password to protect the device.



Back: By clicking this button you can return to the home screen of **NXperience**.

11.3.1 GENERAL PARAMETERS

By clicking on the icon  , you can view the information of the device being configured and the configuration parameters of the RS485 interface.

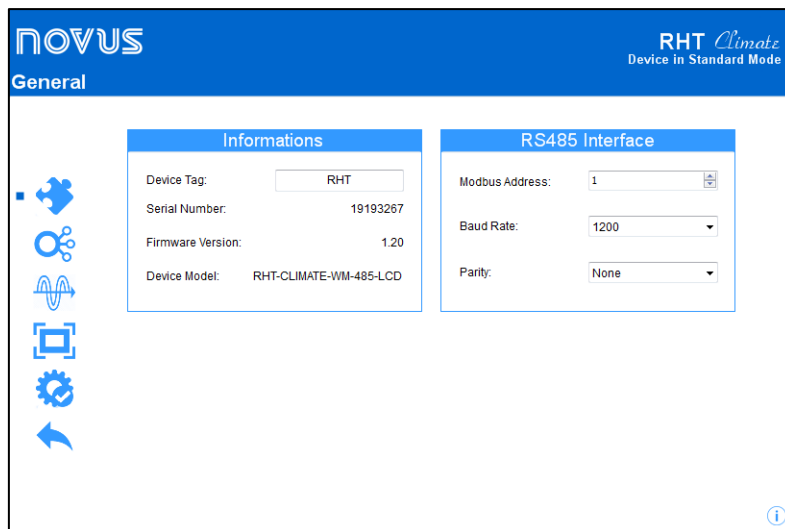



Fig. 31 – General Screen

In the **Device Tag** field, you can assign a name to the device to be configured in order to make it easily identifiable on a network with multiple devices. **Serial Number**, **Firmware Version** and **Model** are read-only fields and are read by the software directly from the device.

In order for the **RHT Climate Transmitter** to be recognized as a slave device in a RS485 Modbus network, it needs to be assigned a unique **Modbus Address** on the network, and the **Baud Rate** and **Parity** need to be configured.

11.3.2 INPUT PARAMETERS

By clicking on the icon  , you can configure the input channel of the temperature and relative humidity sensor.

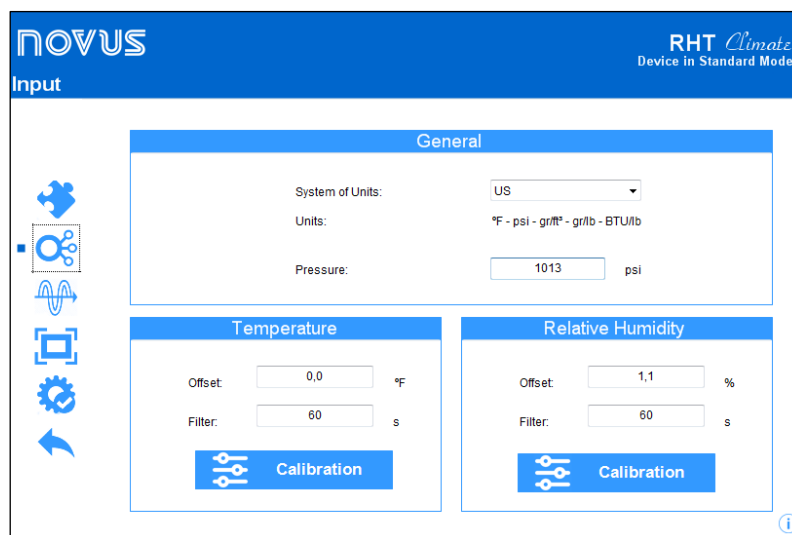
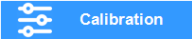

Fig. 32 – Temperature and relative humidity sensor input channel configuration screen

In the **System of Units** field, you can select the international system of measures (**SI**) or the English system of measures (**US**) (see the GENERAL CONFIGURATION CYCLE section).

In the **Pressure** field, the **RHT Climate Transmitter** allows for configuring atmospheric pressure. The device come factory configured with a pressure valor equal to atmospheric pressure at sea level. The values of psychrometric properties calculated by the **RHT Climate Transmitter** may undergo variations due to pressure. In locations with high altitude or in pressurized environments, you need to adjust the value of this parameter so that the **RHT Climate Transmitter** uses it in its offset algorithms.

For the temperature and relative humidity reading, the device provides **Offset** and **Filter** settings. With these features, minor corrections can be made to the sensor readings, and the sensor's response speed can be reduced.

To obtain higher precision from the sensor, the device offers the **Custom Calibration** feature, which lets you insert up to five temperature points and five points for relative humidity. To make this adjustment, click on  to access the custom calibration window. For further details about this feature, refer to the **NXperience** manual at www.novusautomation.com.

11.3.3 OUTPUT PARAMETERS

By clicking on the icon , you can configure the transmission analog outputs, the alarm outputs and the buzzer.

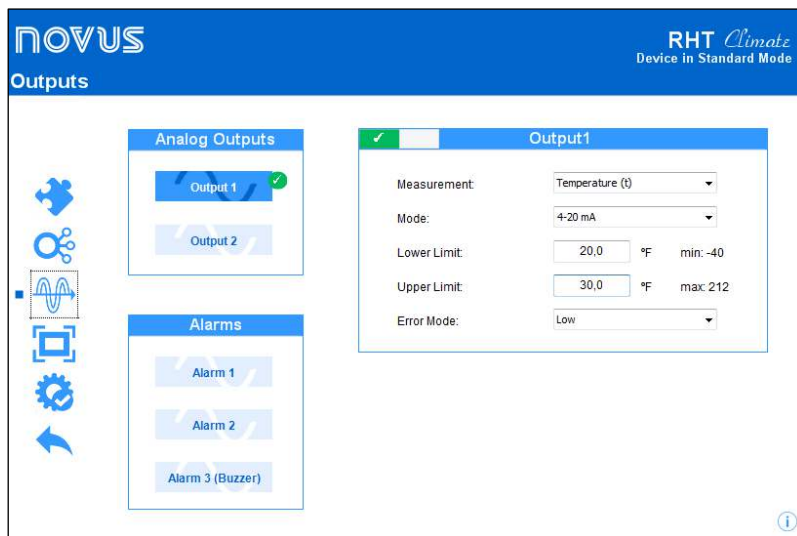

Fig. 33 – Output configuration screen

11.3.3.1 Configuring Transmission Outputs

To select the analog output to be configured, click once on the button for the analog output and enable it by sliding the enable key right.

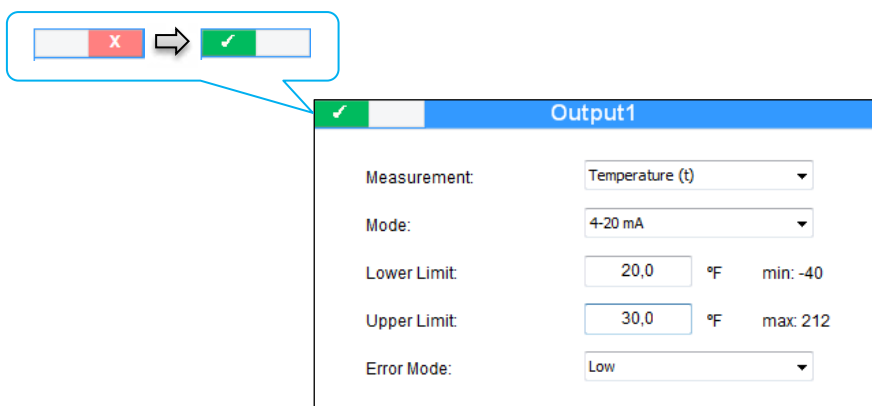

Fig. 34 – Output 1

In the **Measurement** field, the psychrometric property to be transmitted by the analog output can be selected. The analog output **Mode** allows for selecting the electrical standard to be used for transmission: 0-10 V or 4-20 mA. The electrical signal from the output will be proportional to the selected variable, abiding by the values configured for **Lower Limit** and **Upper Limit**.

In case of sensor failure, the variable to be transmitted by the analog output will go into **Error Mode**. For this error condition, you can select **High** or **Low** status.

Mode	Error mode	
	Low	High
0 - 10 V	0 V	10 V
4 - 20 mA	3.6 mA	21.0 mA

Table 66 – Error mode

11.3.3.2 Configuring Alarm and Buzzer Outputs

To select the alarm output to be configured, click once on the button for the alarm output **Alarm 1** and enable it by sliding the enable key right.

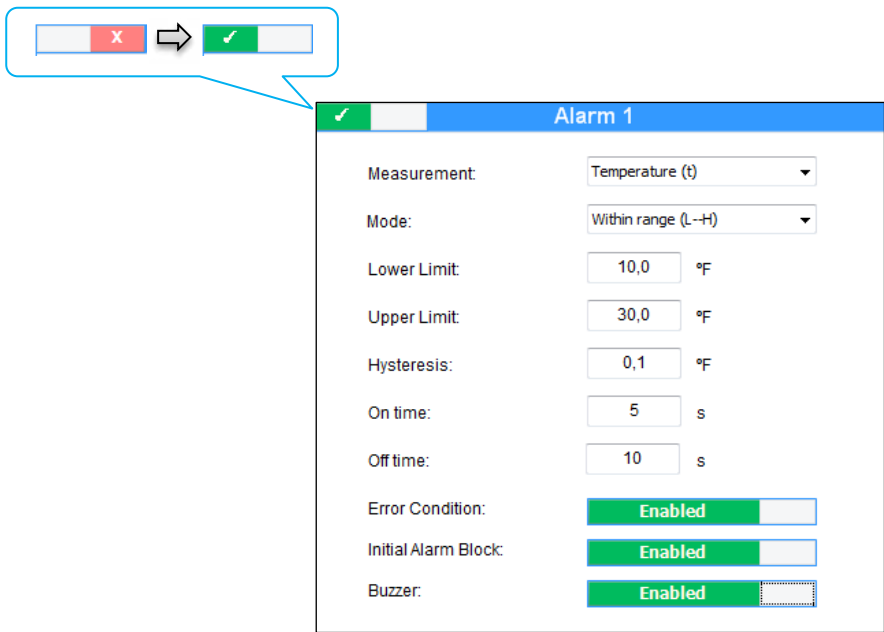

Fig. 35 – Alarm 1

The alarm output may be timed using the **Time on** and **Time off** parameters. Depending on the set values, the output may behave in the following ways: If the device is configured with alarm **Lo, Hi, L-H** or **-LH-**, the **Error condition** parameter allows for configuring the alarm output if the temperature and relative humidity sensor fails. In this case, the output will be turned on or off according to the value configured in this parameter.

In some applications using the **RHT Climate Transmitter**, the occurrence of alarms right when turning the device on may need to be disregarded. A typical example is an application in which an environment needs to be kept cool. Supposing that the alarm is configured to go off when temperatures is lower than -10 °C or higher than 2 °C, if the initial environment temperature is 25 °C when the **RHT Climate Transmitter** is turned on, the alarm will be activated. To inhibit this initial activity, you can enable **Initial alarm blocking**. With initial blocking enabled, the device will need to reach a non-alarm condition for an alarm event to activate the output.

The buzzer* activation can be linked to each alarm output. As such, whenever the alarm output is turned on, the buzzer will be activated, abiding by the buzzer timing configurations. To link the buzzer to the alarm output, the **Buzzer** parameter must be enabled.

*The buzzer can only be linked to an alarm output in LCD models.

To select the buzzer configurations, click once on the button **Alarm 3 (Buzzer)** and enable it by sliding the enable key right.

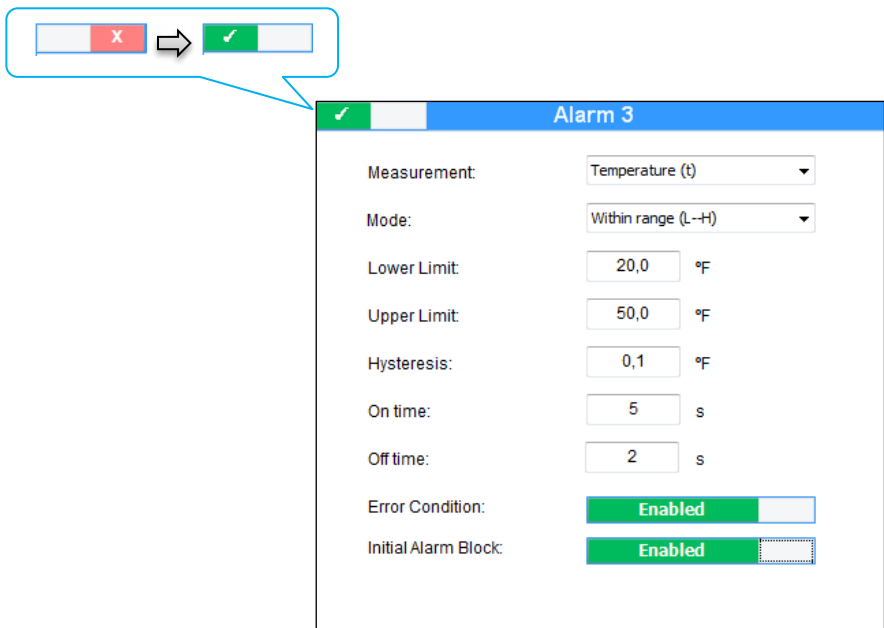



Fig. 36 – Alarm 3

The buzzer configurations are similar to those of alarms 1 and 2.

11.3.4 HMI PARAMETERS

By clicking on the icon , you can configure some features of the display and keyboard of the device. These features are available for the LCD models.

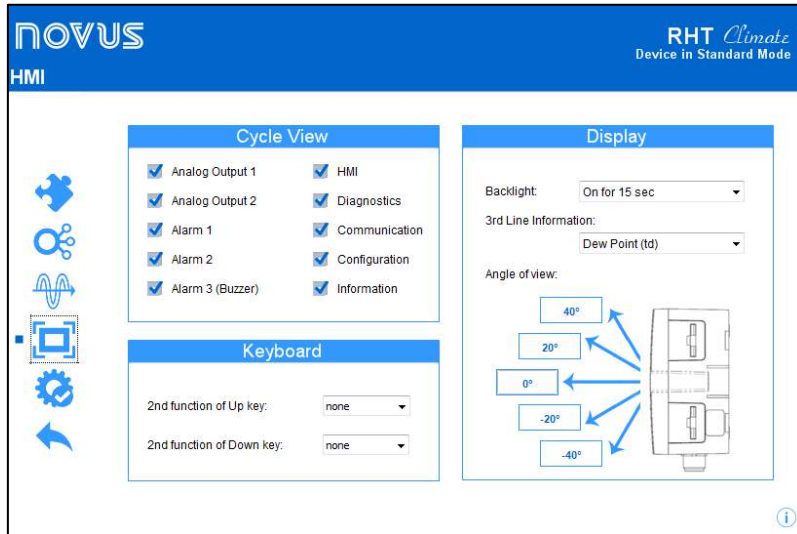



Fig. 37 – HMI Parameters

On this screen you can:

- Select the configuration cycles that will be visible on the HMI;
- Set the second function of key  and key ;
- Select the **Backlight** operating mode;
- Select the information to be displayed on the third line of the display;
- And adjust the display contrast to favor the viewing angle.

When navigating through the **RHT Climate Transmitter** configuration screens via the device keypad, only those cycles that are enabled by **NXperience** can be accessed. In the example of the figure below, you can only navigate between the selected screens:

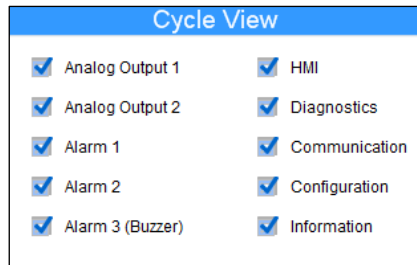



Fig. 38 – Cycle View

The device keys  and , in addition to the increase, decrease, and option selection functions, may have a second function that adds more versatility to the device. The figure below shows the configuration interface for this feature in **NXperience**.

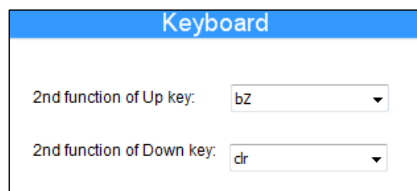





Fig. 39 – Keyboard

For the key , the second function can be selected among these options:

- None;
- Blocks buzzer;
- Blocks buzzer and alarm output.

If the second function of the key  is configured to suppress the buzzer, and if this key is pressed and held during an alarm, the buzzer will be muted but the alarm output will remain enabled.

If the second function of the key  is configured to suppress the buzzer and the alarm output, and if this key is pressed and held during an alarm, the buzzer will be muted and the alarm output will be turned off. The buzzer and the alarm output will only be reactivated if the **RHT Climate Transmitter** goes into a non-alarm condition and returns to an alarm condition.

For key , the second function can be selected from among these options:

- None;
- Reset minimum and maximum values.

If the second function of key  is configured to reset the minimum and maximum values, and if any this key is pressed and held when viewing any minimum and maximum indication screen, the minimum and maximum values of all psychrometric properties will be reset for the device.

The figure below shows the display's backlight and contrast configuration interface:

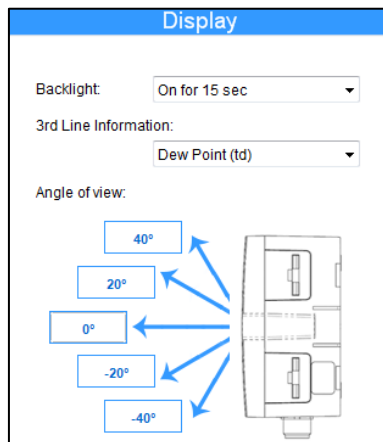

Fig. 40 – Display

For this device, the **Backlight** operating mode can be selected, which operates as follows:

- **Off:** The display backlight is always off;
- **On:** The display backlight is always on;
- **On for a time:** The display backlight always comes on when a key is pressed. If no key is pressed for 15 seconds, the backlight will turn off automatically.

The **RHT Climate Transmitter** display allows for setting five contrast levels that favor viewing of display information from different viewing angles. To select the best angle, click on the desired angle value.

It is also possible to configure the information to be displayed on the third line of the display, as shown in the **3RD Line Information** parameter:

- **Off:** The third line will not display any information.
- **Dew Point:** The third line will display the current value of the dew point.
- **Absolute Humidity:** The third line will display the current value of the absolute humidity.
- **Frost Point:** The third line will display the current value of the frost point.
- **Specific Enthalpy:** The third line will display the current value of the specific enthalpy.
- **Partial Vapor Pressure:** The third line will display the current value of the partial vapor pressure.
- **Mixture Ratio:** The third line will display the current value of the mixture ratio.

11.3.5 FINALIZATION PARAMETERS

By clicking on the icon  , the software will display the screen below and you can send the configuration to the device, save the configurations in a file, update the device firmware, and configure a password to protect the device.

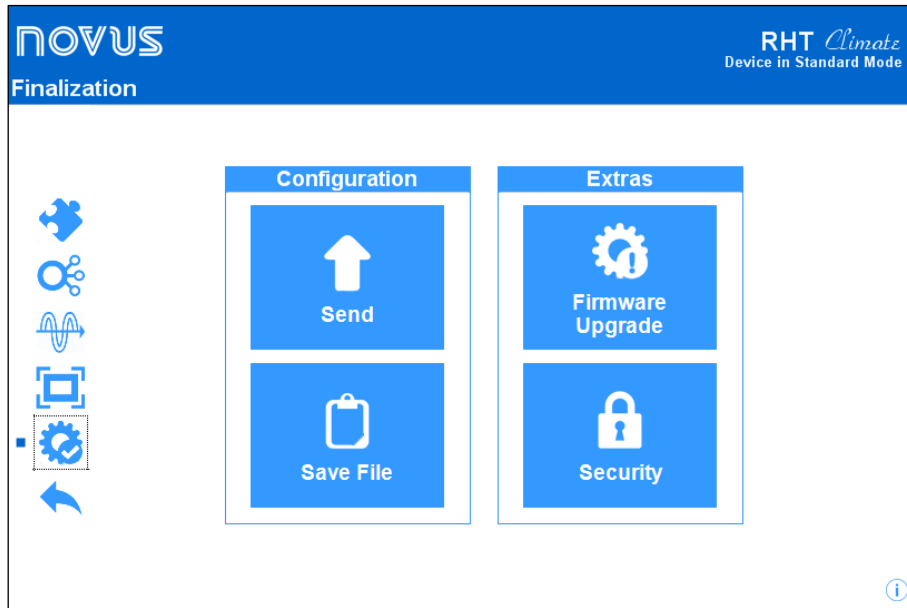

Fig. 41 – Finalization parameters

11.4 DIAGNOSTICS

In the RHT *Climate* Transmitter configuration screen, there is the "Diagnostics" screen. By clicking on it, the software will monitor some device states. The information update interval is 1 second.

In this section you can check whether the device is working properly by forcing temperature and relative humidity readings, alarm outputs and buzzer.

11.4.1 INPUT DIAGNOSTICS

The input diagnostics shows information about the instantaneous value of the psychrometric properties, displayed with two decimal places. In addition, it is also possible to force a value of temperature or relative humidity with one decimal place. To force a value, use the slider or type the input value for temperature or relative humidity and then press the button **Force**.

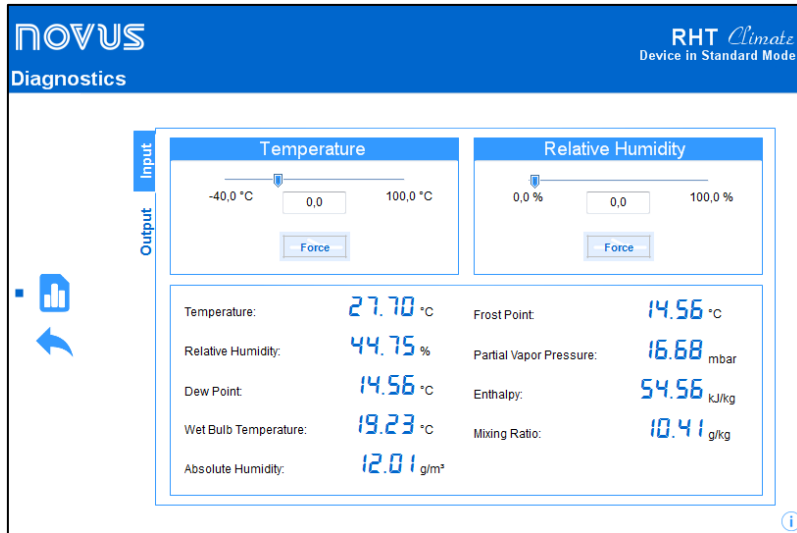

Fig. 42 – Diagnostics parameters

In the example shown on the screen below, the value of 18 °C is being forced in the temperature field, while the relative humidity value is being read directly from the sensor. The other psychrometric properties are calculated by the RHT *Climate* Transmitter based on these values. Note that the button that was used for forcing temperature changed to **Release**.

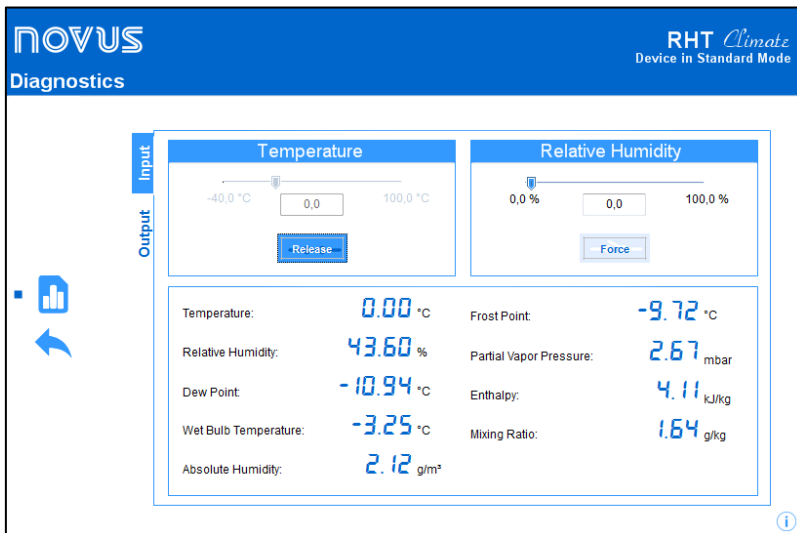

Fig. 43 – Diagnostics Input Parameters

11.4.2 OUTPUT DIAGNOSTICS

During output diagnostics, you can force voltage or current values at the two transmission analog outputs. The transmission mode (0 - 10 V or 4 – 20 mA) that will be forced at outputs depends on the configuration applied to each of them. The alarm outputs and the buzzer also have the forcing feature and need to be enabled for forcing to be possible. Output forcing is very useful for checking proper functioning of the device and testing the configurations applied to the **RHT Climate Transmitter**. The figure below shows the output forcing screen in **NXperience**.

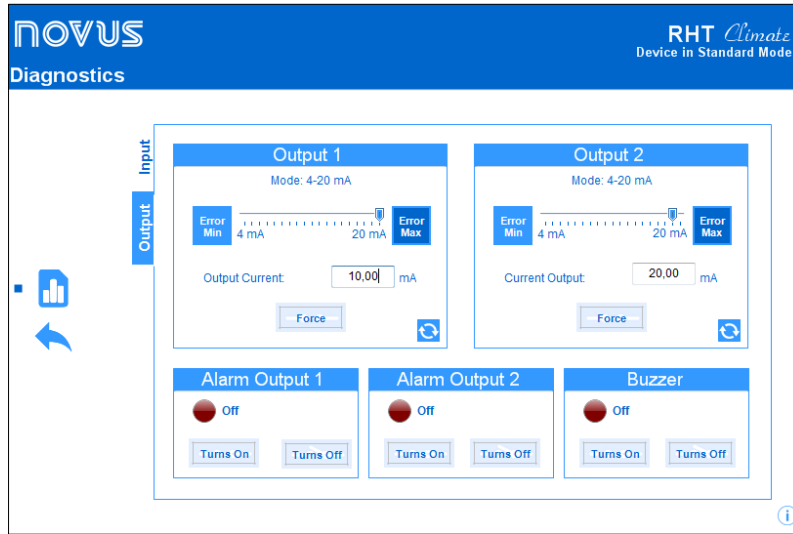

Fig. 44 – Diagnostics Output Parameters

To force a value at a transmission analog output use the slider or type the desired value directly into the edit field and then press the button **Force**. As of this time, the **RHT Climate Transmitter** will be forcing the set value at the transmission output. Note that the button that was used for forcing changed to **Release**.

If you press the key again, the forced value is no longer applied to the output. In the example on the screen below, the 10.0 mA value is being forced at analog output 1.

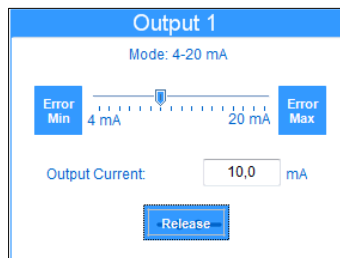

Fig. 45 – Output 1

For each analog output, transmission of an error value can also be forced via buttons **Error min** and **Error max**. These values depend on the mode (0-10 V or 4-20 mA) configured for each output.

Alarm and buzzer outputs allow for forcing the on and off condition. As the alarm output can be activated due to an alarm condition in some cases, it may be desirable to force the off status so that you can identify a possible failure in the device's electrical installation or configuration.

The images below show the interface for forcing alarm output 1 in the three possible conditions: Without forcing, forcing in on state, and forcing in off state.

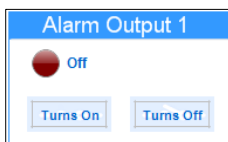

Fig. 46 – Alarm 1 output without forcing

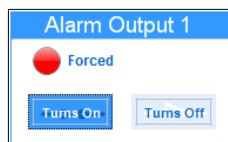

Fig. 47 – Alarm 1 output with forcing in on state

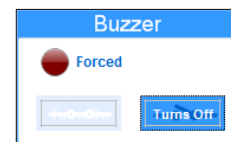
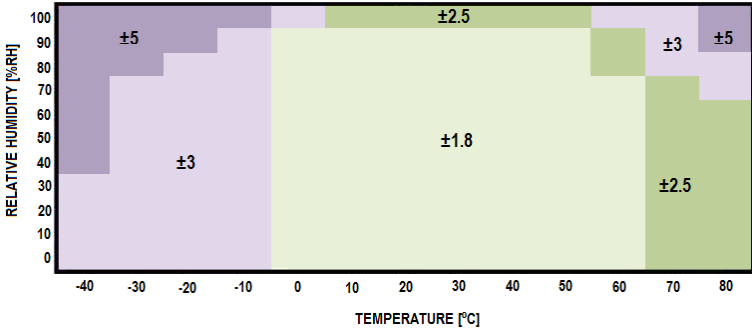

Fig. 48 – Alarm 1 output with forcing in off state

12 TECHNICAL SPECIFICATIONS

Humidity measurement	Measurement range: <ul style="list-style-type: none"> • Configurable: Between 0 % RH and 100 % RH (no condensing); • Configurable: Between -90 °C at 100 °C in dew point. 																	
	Response time (1/e (63 %)): < 4 seconds @25 °C (with air moving at 1 m/s and polyamide tip)																	
Temperature measurement	Measuring Range: <ul style="list-style-type: none"> • -40 °C to 100 °C for DM models; • -40 °C to 60 °C for WM models. 																	
	Response time (1/e (63 %)): < 5 seconds @25 °C (with air moving at 1 m/s and polyamide tip).																	
Accuracy	<ul style="list-style-type: none"> • Temperature: ± 0.4 °C (0 °C to 60 °C); • Relative Humidity: See image below. 																	
	 <p>Other error sources:</p> <table border="1" data-bbox="432 1043 1426 1312"> <thead> <tr> <th>Error Source</th> <th>Humidity</th> <th>Temperature</th> </tr> </thead> <tbody> <tr> <td>Degradation over time</td> <td>< 0.5 % RH/year</td> <td>< 0.05 °C/year</td> </tr> <tr> <td>Reproducibility</td> <td>± 0.2 % RH</td> <td>± 0.1 °C</td> </tr> <tr> <td>Linearity</td> <td>< ± 1 % RH</td> <td>Does not apply</td> </tr> <tr> <td>Hysteresis</td> <td>< ± 1 % RH</td> <td>Does not apply</td> </tr> <tr> <td>Thermal drift</td> <td>0.05 % RH/°C</td> <td>Does not apply</td> </tr> </tbody> </table>	Error Source	Humidity	Temperature	Degradation over time	< 0.5 % RH/year	< 0.05 °C/year	Reproducibility	± 0.2 % RH	± 0.1 °C	Linearity	< ± 1 % RH	Does not apply	Hysteresis	< ± 1 % RH	Does not apply	Thermal drift	0.05 % RH/°C
Error Source	Humidity	Temperature																
Degradation over time	< 0.5 % RH/year	< 0.05 °C/year																
Reproducibility	± 0.2 % RH	± 0.1 °C																
Linearity	< ± 1 % RH	Does not apply																
Hysteresis	< ± 1 % RH	Does not apply																
Thermal drift	0.05 % RH/°C	Does not apply																
Power supply	<ul style="list-style-type: none"> • Power supply via PWR terminals: 12 Vdc to 30 Vdc; • Power supply via USB cable: 4.75 Vdc to 5.25 Vdc; Internal protection against power supply voltage reverse polarity.																	
Maximum power supply current	< 70 mA ± 10 % @ 24 Vdc																	
Out1 / Out2 Output	They may be configured independently to operate with signals 0-10 V or 4-20 mA. <ul style="list-style-type: none"> • 0-10 V <ul style="list-style-type: none"> ○ Maximum current: 2 mA; ○ Resolution: 0.003 V. • 4-20 mA <ul style="list-style-type: none"> ○ 500 R maximum load; ○ Resolution: 0.006 mA. 																	
ALN1 Alarm ALN2 Alarm	<ul style="list-style-type: none"> • Channel N 30 V / 200 mA type output; • Protection against current > 200 mA; • Current protection reset time: 5 seconds. 																	
Protection rating	<ul style="list-style-type: none"> • Electronic module housing: IP65; • Sensor capsule: IP40 or IP20, according to the models: sintered PTFE (with device) or polyamide (optional). 																	
Housing	ABS+PC																	
NXperience	Windows 10, 8 / 8.1, 7, Vista and XP (32 and 64 bits) configurator software. Menus in Portuguese, Spanish, French and English.																	

Certifications	CE Mark This is a Class A product. In a domestic environment, this product may cause radio interference in which case the user may be required to take adequate measures.
-----------------------	---

Table 67 – Technical specifications

13 WARRANTY

Warranty conditions are available on our website www.novusautomation.com/warranty.

14 APPENDIX I – NOTIONS ABOUT PSYCHROMETRY

Psychrometry is the study of thermodynamic properties of dry air and water vapor mixtures. Obtaining the psychrometric properties is crucial in the psychrometric processes of air conditioning, refrigeration, cooling and freezing, air humidification and dehumidification, drying and dehydration of humid devices, as well as in environmental and meteorological control.

The psychrometric properties provided by the RHT *Climate Transmitter* are:

- Dry Bulb Temperature
- Relative Humidity
- Dew Point Temperature
- Wet Bulb Temperature
- Absolute Humidity
- Frost Point Temperature
- Specific Enthalpy
- Partial Vapor Pressure
- Mixture Ratio

Dry Bulb Temperature [°C] or [°F]:

It is simply the temperature of the air and water vapor mixture surrounding the thermometer.

Relative Humidity [%RH]:

Relative humidity expresses the percentage of water vapor contained in a certain amount of air. When the air reaches 100% relative humidity, it will have reached its maximum water absorption capacity. In this condition, the air is said to be saturated and water vapor condensation starts to be evident on the surfaces surrounded by this mixture.

Dew Point Temperature [°C] or [°F]:

The dew point is defined as the temperature to which the air must be cooled in order for water condensation to begin, meaning in order for the air to be saturated with water vapor. At dew point temperature, the amount of water vapor present in the air is maximum.

The capacity to retain water by air is heavily dependent on temperature: hot air can retain more water. The dew point is typically used to represent the amount of water vapor in dry air or gas. At low humidity, changes in dew point temperature are greater than changes in relative humidity, allowing for greater measurement precision and control.

Wet Bulb Temperature [°C] or [°F]:

The wet bulb temperature is measured by a thermometer with bulb covered by a mesh (usually cotton) that is submerged in a recipient containing distilled water. Water evaporation draws out heat from the bulb, making the wet bulb thermometer indicate a temperature lower than the ambient air. Evaporation consumes heat, causing cooling. This evaporation, and consequently the wet bulb temperature, is greater when the atmospheric air is drier, and is null when the atmosphere is saturated with water vapor (relative air humidity equal to 100%).

Absolute humidity [g/m³] or [gr/ft³]:

Absolute humidity expresses the mass of water vapor contained in a given volume. If all the water of one cubic meter of air is condensed in a vessel, this vessel will contain all the absolute humidity of that portion of air and the amount of condensed water can be weighed to quantify the absolute humidity.

Frost Point Temperature [°C] or [°F]:

The frost point temperature is the temperature to which air must be cooled, with constant pressure, to reach saturation (in relation to liquid water) and to settle in the form of frost on a surface.

Specific enthalpy [kJ/kg] or [BTU/lb]:

It is the energy contained in moist air by the amount of dry air. For a given mass of air to occupy a given volume at a given pressure, this occurs at the expense of energy. The higher the relative air humidity, the higher its specific enthalpy will be.

Partial Vapor Pressure [mbar] or [psi]:

The partial pressure of a gas in a gaseous mixture of ideal gases corresponds to the pressure that it would exert if it were occupying the whole container alone, at the same temperature as the ideal mixture. As such, the total pressure is calculated via the sum of partial pressures of the gases that make up the mixture.

Mixture Ratio [g/kg] or [gr/lb]:

The mixture ratio is expressed as the ratio of the mass of water vapor per kilogram of dry air into any portion of the atmosphere separated for study. The mixture ratio varies with temperature, except if the temperature is lower than the dew point, or when the air is completely saturated with water vapor. In these conditions, the drop in temperature will cause forced water condensation.