

August 1991

Features

- 10A and 8.3A, 400V - 350V
- $r_{DS(on)} = 0.55\Omega$ and 0.80Ω
- Single Pulse Avalanche Energy Rated*
- SOA is Power-Dissipation Limited
- Nanosecond Switching Speeds
- Linear Transfer Characteristics
- High Input Impedance

Description

The IRF340, IRF341, IRF342, and IRF343 are n-channel enhancement-mode silicon-gate power field-effect transistors. IRF340R, IRF341R, IRF342R, and IRF343R types are advanced power MOSFETs designed, tested, and guaranteed to withstand a specified level of energy in the breakdown avalanche mode of operation. All of these power MOSFETs are designed for applications such as switching regulators, switching converters, motor drivers, relay drivers, and drivers for high-power bipolar switching transistors requiring high speed and low gate-drive power. These types can be operated directly from integrated circuits.

The IRF types are supplied in the JEDEC TO-204AA steel package.

Package

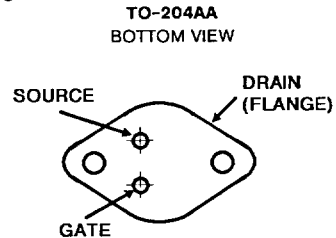

Terminal Diagram

N-CHANNEL ENHANCEMENT MODE

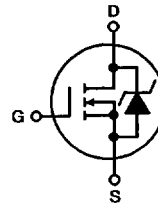

Absolute Maximum Ratings ($T_C = +25^\circ\text{C}$), Unless Otherwise Specified

	IRF340 IRF340R	IRF341 IRF341R	IRF342 IRF342R	IRF343 IRF343R	UNITS		
Drain-Source Voltage (1)	V_{DS}	400	350	400	350	V	
Drain-Gate Voltage ($R_{GS} = 20k\Omega$) (1)	V_{DGR}	400	350	400	350	V	
Continuous Drain Current	I_D	10	10	8.3	8.3	A	
$T_C = +25^\circ\text{C}$	I_D	6.3	6.3	5.2	5.2	A	
$T_C = +100^\circ\text{C}$	I_{DM}	40	40	33	33	A	
Pulsed Drain Current (3)	V_{GS}	± 20	± 20	± 20	± 20	V	
Gate-Source Voltage	P_D	125	125	125	125	W	
Maximum Power Dissipation	Linear Derating Factor	1.0	1.0	1.0	1.0	W/ $^\circ\text{C}$	
Inductive Current, Clamped	I_{LM}	40	40	32	32	A	
(See Figure 14, $L = 100\mu\text{H}$)	Single Pulse Avalanche Energy Rating (4)	E_{AS}^*	520	520	520	520	mJ
Operating and Storage Junction	T_J, T_{STG}	-55 to +150	-55 to +150	-55 to +150	-55 to +150	$^\circ\text{C}$	
Temperature Range	Maximum Lead Temperature for Soldering	T_L	300	300	300	300	$^\circ\text{C}$
(0.063" (1.6mm) from case for 10s)							

NOTES:

1. $T_J = +25^\circ\text{C}$ to $+150^\circ\text{C}$.

2. Pulse Test: Pulse width $\leq 300\mu\text{s}$, Duty Cycle $\leq 2\%$.

3. Repetitive Rating: Pulse width limited by max junction temp. See Transient Thermal Impedance Curve (Figure 5).

4. $V_{DD} = 50\text{V}$, starting $T_J = +25^\circ\text{C}$, $L = 9.2\text{mH}$, $R_{GS} = 25\Omega$, $I_{PEAK} = 10\text{A}$. See Figure 15.

* R Suffix Types Only

IRF340, IRF341, IRF342, IRF343 IRF340R, IRF341R, IRF342R, IRF343R

4
N-CHANNEL
POWER MOSFETS

Electrical Characteristics $T_C = +25^\circ\text{C}$, Unless Otherwise Specified

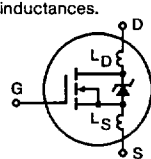
CHARACTERISTIC	SYMBOL	TEST CONDITIONS	LIMITS			UNITS
			MIN	TYP	MAX	
Drain-Source Breakdown Voltage IRF340/342, IRF340R/342R IRF341/343, IRF341R/343R	BV_{DSS}	$V_{GS} = 0V, I_D = 250\mu A$	400 350	- -	- -	V V
Gate Threshold Voltage	$V_{GS(TH)}$	$V_{DS} = V_{GS}, I_D = 250\mu A$	2.0	-	4.0	V
Gate-Source Leakage Forward	I_{GSS}	$V_{GS} = 20V$	-	-	100	nA
Gate-Source Leakage Reverse	I_{GSS}	$V_{GS} = -20V$	-	-	-100	nA
Zero Gate Voltage Drain Current	I_{DSS}	$V_{DS} = \text{Max Rating}, V_{GS} = 0V$	-	-	250	μA
		$V_{DS} = \text{Max Rating} \times 0.8, V_{GS} = 0V, T_J = +125^\circ\text{C}$	-	-	1000	μA
On-State Drain Current (Note 2) IRF340/341, IRF340R/341R IRF342/343, IRF342R/343R	$I_{D(ON)}$	$V_{DS} > I_{D(ON)} \times r_{DS(ON)} \text{ Max}, V_{GS} = 10V$	10 8.3	- -	- -	A A
Static Drain-Source On-State Resistance (Note 2) IRF340/341, IRF340R/341R IRF342/343, IRF342R/343R	$r_{DS(ON)}$	$V_{GS} = 10V, I_D = 5.2A$	- -	0.4 0.5	0.55 0.80	Ω Ω
Forward Transconductance (Note 2)	g_{fs}	$V_{DS} \geq 50V, I_D = 5.2A$	5.8	8	-	S(V)
Input Capacitance	C_{ISS}	$V_{GS} = 0V, V_{DS} = 25V, f = 1.0\text{MHz}$ See Figure 10	-	1250	-	pF
Output Capacitance	C_{OSS}		-	300	-	pF
Reverse Transfer Capacitance	C_{RSS}		-	80	-	pF
Turn-On Delay Time	$t_{d(ON)}$	$V_{DD} = 200V, I_D \approx 10A, R_G = 9.1\Omega$ See Figure 16. (MOSFET switching times are essentially independent of operating temperature)	-	17	21	ns
Rise Time	t_r		-	27	41	ns
Turn-Off Delay Time	$t_{d(OFF)}$		-	45	75	ns
Fall Time	t_f		-	20	36	ns
Total Gate Charge (Gate-Source + Gate-Drain)	Q_g	$V_{GS} = 10V, I_D = 10A, V_{DS} = 0.8 \text{ Max Rating}$. See Figure 17 for test circuit. (Gate charge is essentially independent of operating temperature.)	-	41	63	nC
Gate-Source Charge	Q_{gs}		-	7	-	nC
Gate-Drain ("Miller") Charge	Q_{gd}		-	23	-	nC
Internal Drain Inductance	L_D	Measured between the contact screw on header that is closer to source and gate pins and center of center of die.	-	5.0	-	nH
Internal Source Inductance	L_S	Measured from the source lead, 6mm (0.25") from header and source bonding pad.	-	12.5	-	nH
						
Junction-to-Case	$R_{\theta JC}$		-	-	1.0	$^\circ\text{C/W}$
Case-to-Sink	$R_{\theta CS}$	Mounting surface flat, smooth and greased	-	0.1	-	$^\circ\text{C/W}$
Junction-to-Ambient	$R_{\theta JA}$	Free air operation	-	-	30	$^\circ\text{C/W}$

Source Drain Diode Ratings and Characteristics

Continuous Source Current (Body Diode)	I_S	Modified MOSFET symbol showing the integral reverse P-N junction rectifier.	-	-	10	A
Pulse Source Current (Body Diode) (Note 3)	I_{SM}		-	-	40	A
Diode Forward Voltage (Note 2)	V_{SD}	$T_J = +25^\circ\text{C}, I_S = 10A, V_{GS} = 0V$	-	-	2.0	V
Reverse Recovery Time	t_{rr}	$T_J = +25^\circ\text{C}, I_F = 10A, dI_F/dt = 100A/\mu s$	170	350	790	ns
Reverse Recovered Charge	Q_{RR}	$T_J = +25^\circ\text{C}, I_F = 10A, dI_F/dt = 100A/\mu s$	1.6	4.0	8.2	μC
Forward Turn-on Time	t_{ON}	Intrinsic turn-on time is negligible. Turn-on speed is substantially controlled by $L_S + L_D$.	-	-	-	-

NOTES: 1. $T_J = +25^\circ\text{C}$ to $+150^\circ\text{C}$

2. Pulse Test: Pulse width $\leq 300\mu s$, Duty Cycle $\leq 2\%$

3. Repetitive Rating: Pulse width limited by max. junction temperature. See Transient Thermal Impedance Curve (Figure 5)

4. $V_{DD} = 50V$, Start $T_J = +25^\circ\text{C}$, $L = 9.2\text{mH}$, $R_{GS} = 25\Omega$, $I_{PEAK} = 10A$ (See Figure 15)

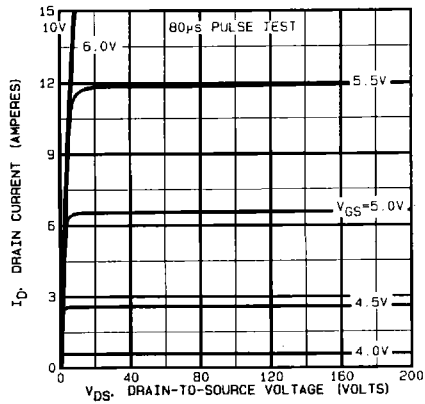

FIGURE 1. TYPICAL OUTPUT CHARACTERISTICS

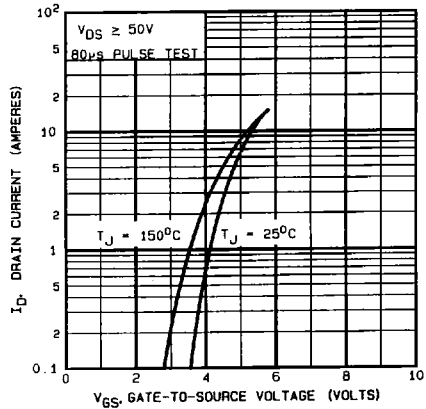

FIGURE 2. TYPICAL TRANSFER CHARACTERISTICS

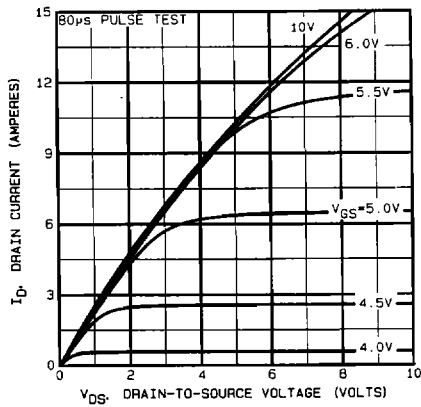

FIGURE 3. TYPICAL SATURATION CHARACTERISTICS

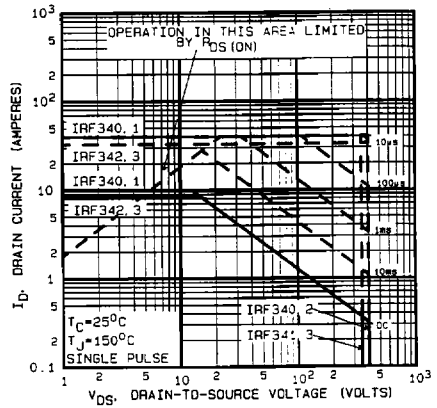

FIGURE 4. MAXIMUM SAFE OPERATING AREA

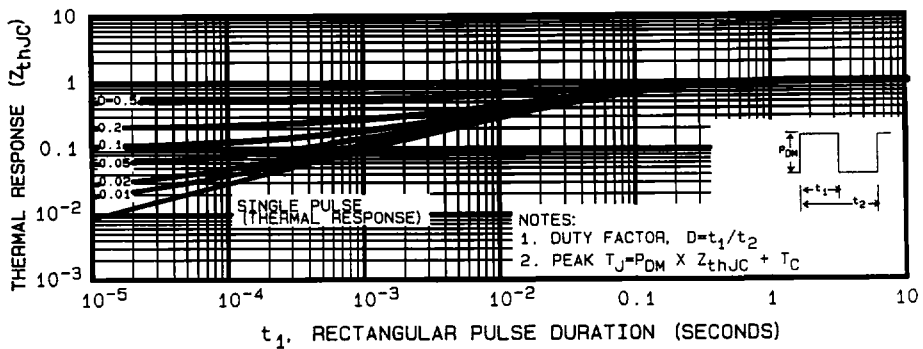

FIGURE 5. MAXIMUM EFFECTIVE TRANSIENT THERMAL IMPEDANCE, JUNCTION-TO-CASE vs PULSE DURATION

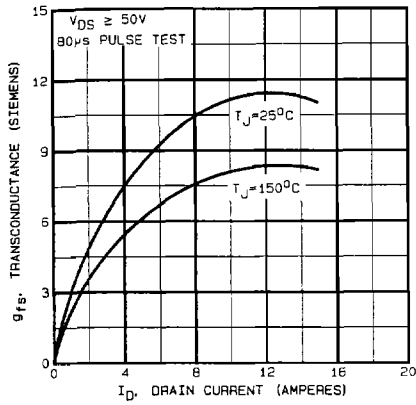

FIGURE 6. TYPICAL TRANSCONDUCTANCE vs DRAIN CURRENT

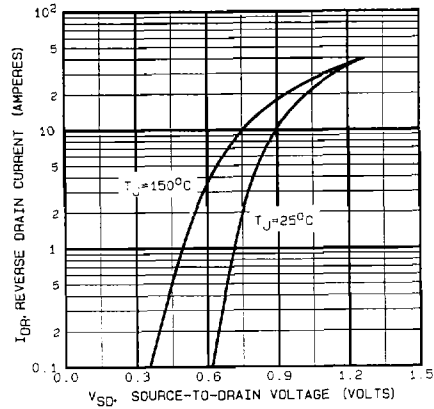

FIGURE 7. TYPICAL SOURCE-DRAIN DIODE FORWARD VOLTAGE

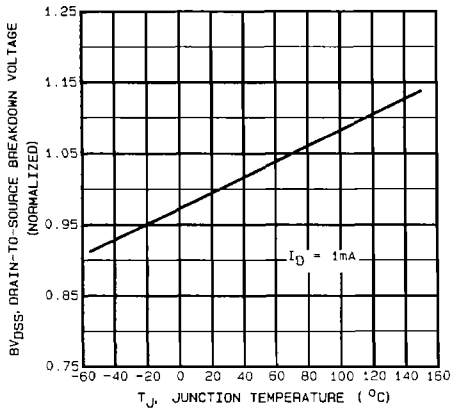

FIGURE 8. BREAKDOWN VOLTAGE vs TEMPERATURE

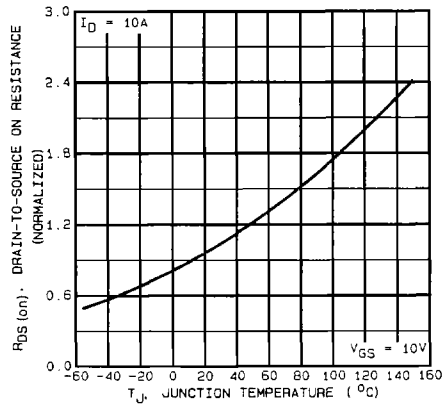

FIGURE 9. NORMALIZED ON-RESISTANCE vs TEMPERATURE

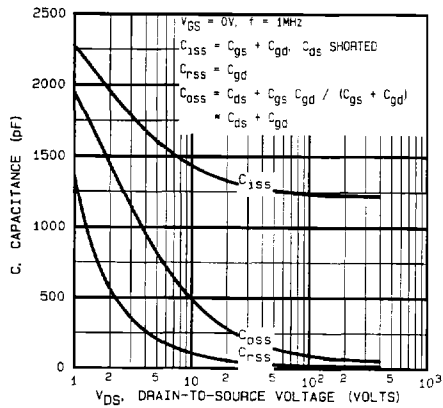

FIGURE 10. TYPICAL CAPACITANCE vs DRAIN-TO-SOURCE VOLTAGE

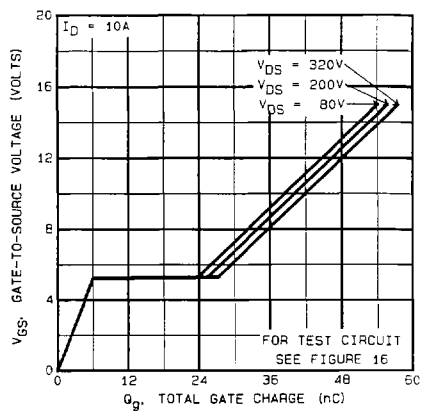

FIGURE 11. TYPICAL GATE CHARGE vs GATE-TO-SOURCE VOLTAGE

4
N-CHANNEL
POWER MOSFETS

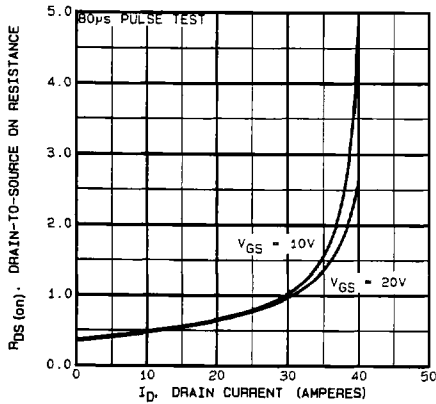

FIGURE 12. TYPICAL ON RESISTANCE vs DRAIN CURRENT

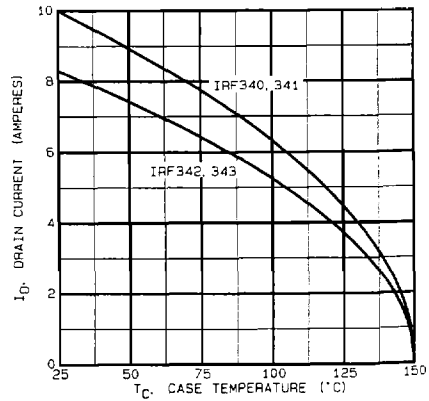

FIGURE 13. MAXIMUM DRAIN CURRENT vs CASE TEMPERATURE

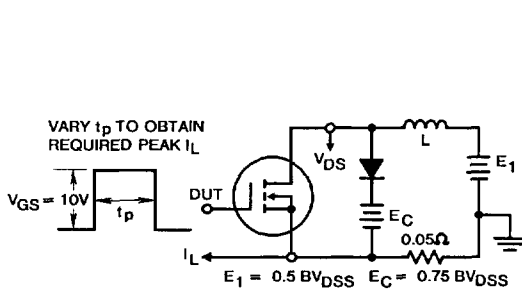

FIGURE 14a. CLAMPED INDUCTIVE TEST CIRCUIT

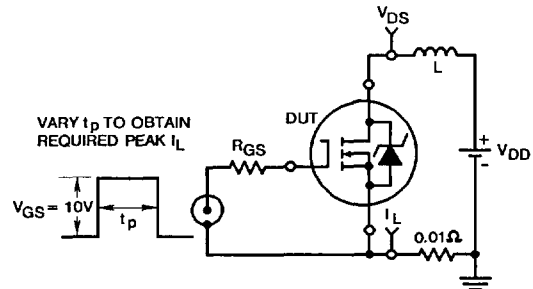

FIGURE 15a. UNCLAMPED ENERGY TEST CIRCUIT

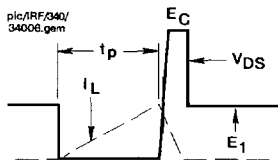

FIGURE 14b. CLAMPED INDUCTIVE WAVEFORMS

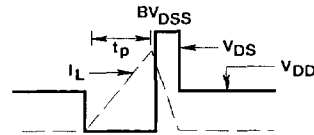

FIGURE 15b. UNCLAMPED ENERGY WAVEFORMS

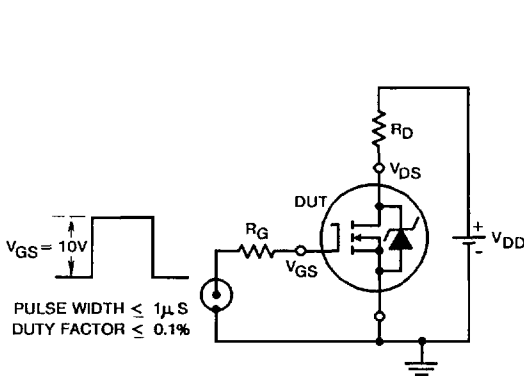

FIGURE 16. SWITCHING TIME TEST CIRCUIT

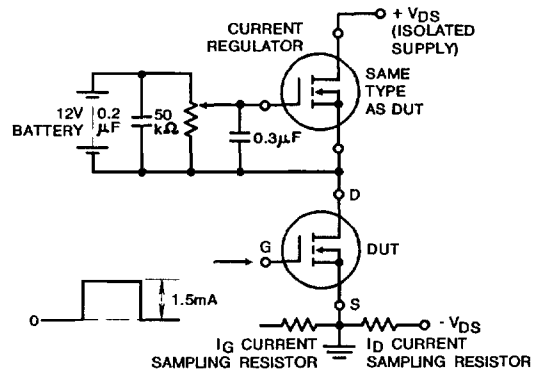

FIGURE 17. GATE CHARGE TEST CIRCUIT