

# XS218SAPAL2

Inductive proximity sensors XS, inductive sensor XS2 M18, L60mm, stainless, Sn12mm, 12...24 VDC, cable 2 m



## Main

|                                    |   |
|------------------------------------|---|
| Range of Product                   | Telemecanique Inductive proximity sensors XS                                    |
| Series name                        | Application   |
| Sensor Type                        | Inductive proximity sensor  |
| Device Application                 | Food and beverage   |
| Market Segment                     | Pharmaceutical  |
| Sensor name                        | XS2   |
| Sensor design                      | Cylindrical M18   |
| Size                               | 60 mm   |
| Body type                          | Fixed   |
| Detector flush mounting acceptance | Non flush mountable   |
| Material                           | Stainless steel   |
| Type of output signal              | Discrete  |
| Wiring Technique                   | 3-wire  |
| [Sn] nominal sensing distance      | 0.47 in (12 mm)   |
| Discrete output function           | 1 NO  |
| Output circuit type                | DC  |
| Discrete output type               | PNP   |
| Electrical connection              | Cable   |
| Cable length                       | 6.56 ft (2 m)   |
| [Us] rated supply voltage          | 12...24 V DC reverse polarity protection  |
| Switching capacity in mA           | <= 200 mA overload and short-circuit protection                                 |
| IP degree of protection            | IP68 double insulation conforming to IEC 60529<br>IP69K conforming to DIN 40050 |

## Complementary

|                          |                                |
|--------------------------|--------------------------------|
| Thread type              | M18 x 1                        |
| Detection face           | Frontal                        |
| Front material           | PPS                            |
| Enclosure Material       | Stainless steel 316 L          |
| Sensing range            | > 0.31...0.59 in (> 8...15 mm) |
| Operating zone           | 0.00...0.38 in (0...9.6 mm)    |
| Differential travel      | 1...15% of Sr                  |
| Cable composition        | 3 x 0.34 mm <sup>2</sup>       |
| Wire insulation material | PVC                            |
| Status LED               | Output state 1 LED yellow)     |
| Supply voltage limits    | 10...36 V DC                   |
| Switching frequency      | <= 1000 Hz                     |
| Maximum voltage drop     | <2 V closed)                   |
| Current consumption      | <= 10 mA no-load               |
| Maximum delay first up   | 10 ms                          |
| Maximum delay response   | 0.3 ms                         |
| Maximum delay recovery   | 0.7 ms                         |

|                 |                       |
|-----------------|-----------------------|
| Marking         | CE                    |
| Threaded length | 1.57 in (40 mm)       |
| Length          | 2.36 in (60 mm)       |
| Net Weight      | 0.26 lb(US) (0.12 kg) |

## Environment

|                                       |   |
|---------------------------------------|---|
| Product Certifications                | CSA<br>UL                               |
| Ambient air temperature for operation | -13...185 °F (-25...85 °C)              |
| Ambient Air Temperature for Storage   | -40...185 °F (-40...85 °C)              |
| Vibration resistance                  | 25 gn +/- 2 mm 10...55 Hz)IEC 60068-2-6 |
| Shock resistance                      | 50 gn 11 ms IEC 60068-2-27              |





## Ordering and shipping details

|                       |                            |
|-----------------------|----------------------------|
| Category              | 22486 - SENSORS, PROXIMITY |
| Discount Schedule     | DS2                        |
| GTIN                  | 3389119113144              |
| Nbr. of units in pkg. | 1                          |
| Package weight(Lbs)   | 3.81 oz (108 g)            |
| Returnability         | Yes                        |
| Country of origin     | FR                         |

## Packing Units

|                              |                        |
|------------------------------|------------------------|
| Unit Type of Package 1       | PCE                    |
| Package 1 Height             | 1.10 in (2.8 cm)       |
| Package 1 width              | 5.00 in (12.7 cm)      |
| Package 1 Length             | 5.12 in (13 cm)        |
| Unit Type of Package 2       | S02                    |
| Number of Units in Package 2 | 22                     |
| Package 2 Weight             | 5.80 lb(US) (2.632 kg) |
| Package 2 Height             | 5.91 in (15 cm)        |
| Package 2 width              | 11.81 in (30 cm)       |
| Package 2 Length             | 15.75 in (40 cm)       |
| Package 3 Height             | 5.91 in (15 cm)        |

## Offer Sustainability

|                            |   |
|----------------------------|---|
| Sustainable offer status   | Green Premium product   |
| California proposition 65  | WARNING: This product can expose you to chemicals including: Diisononyl phthalate (DINP), which is known to the State of California to cause cancer, and Di-isodecyl phthalate (DIDP), which is known to the State of California to cause birth defects or other reproductive harm. For more information go to <a href="http://www.P65Warnings.ca.gov">www.P65Warnings.ca.gov</a> |
| REACH Regulation           |  <a href="#">REACH Declaration</a>   |
| EU RoHS Directive          | Pro-active compliance (Product out of EU RoHS legal scope)  <a href="#">EU RoHS Declaration</a>  |
| Mercury free               | Yes   |
| RoHS exemption information |  Yes   |
| Environmental Disclosure   |  <a href="#">Product Environmental Profile</a>   |
| Circularity Profile        |  <a href="#">End Of Life Information</a>   |

## Contractual warranty

|          |           |
|----------|-----------|
| Warranty | 18 months |
|----------|-----------|

Dimensions

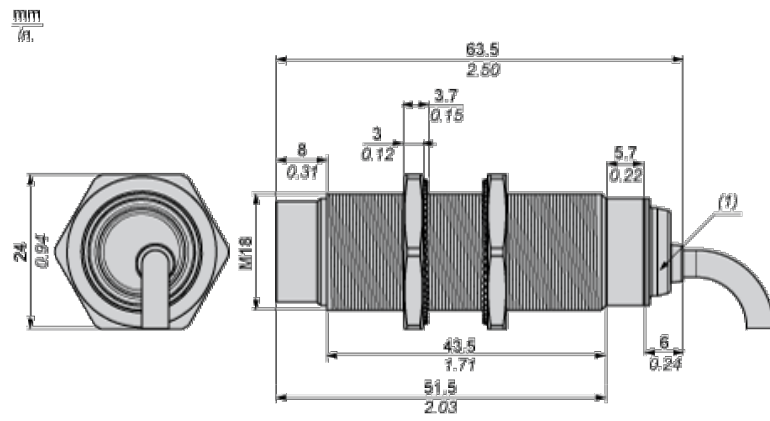

(1) LED

---

Minimum Mounting Distances

---

Side by side



e (1) 72 mm/2.83 in.

≥

Face to face

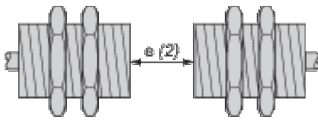

e (2) 144 mm/5.67 in.

≥

Facing a metal object

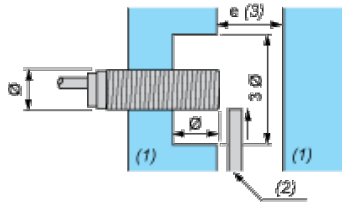

e (3) 36 mm/1.42 in

≥

(1) Metal

(2) Object to be detected

---

Mounting

---

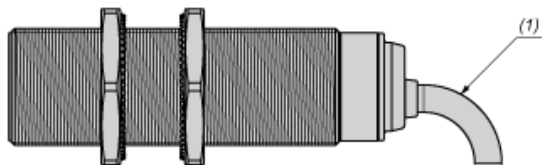

(1) Bending cable: 4 x external cable diameter

---

## Wiring Schemes

---

PNP

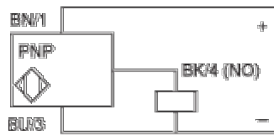

BU : Blue  
BN : Brown  
BK : Black