

75 Ohm SMB Right Angle Crimp Type Plug - Captivated Contact

INCHES (MILLIMETERS)
CUSTOMER DRAWINGS AVAILABLE UPON REQUEST

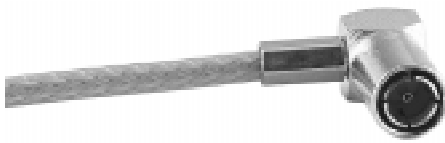

CABLE TYPE	GOLD PLATED	NICKEL PLATED	"A"	"B"
RG-179, 187	131-8403-101	131-8403-106	.505 (12.83)	.380 (9.65)

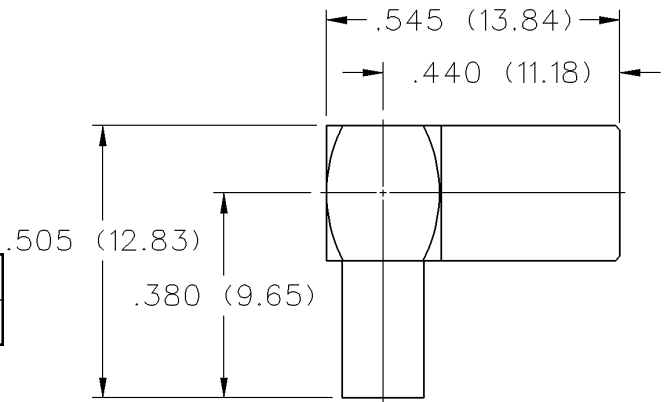

1. Identify connector parts. (4 piece parts: crimp sleeve, body assembly, expansion cap and covering ring. Die cast body only.)
2. Strip cable to dimensions shown. Do not nick braid or center conductor. A wire stripper of correct size is recommended for this step. Twist stranded center conductor into tight bundle and tin (optional). Slide crimp sleeve onto cable as shown.
3. Flare braid and slide cable into body assembly making certain that the cable insulation bottoms on center contact. Solder center conductor to contact through the rear and side access ports. Use a minimum amount of solder for a good joint. **.020 (0.51) diameter solder is recommended.**
4. Arrange braid uniformly around crimp stem of body assembly. Slide crimp sleeve over braid and crimp securely using recommended crimp tool. Place expansion cap in access port and seat with a .125 (3.17) diameter flat punch. Snap cover ring over side access port.

CABLE GROUP	PART NUMBER	"A"	"B"	CRIMP HEX
RG-179/u, 187, 316, 161, 174, 188	131-8403-101/106	.177 (4.50)	.289 (7.34)	.128 (3.25)

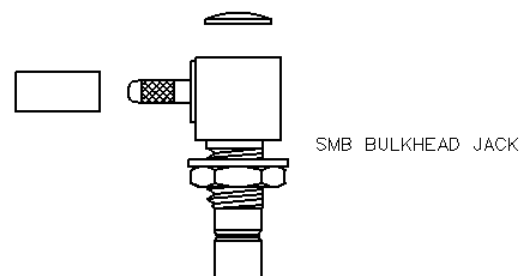
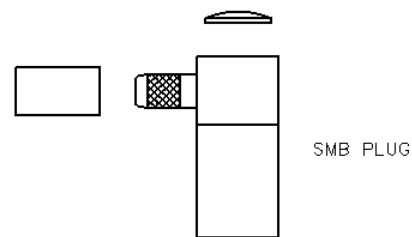
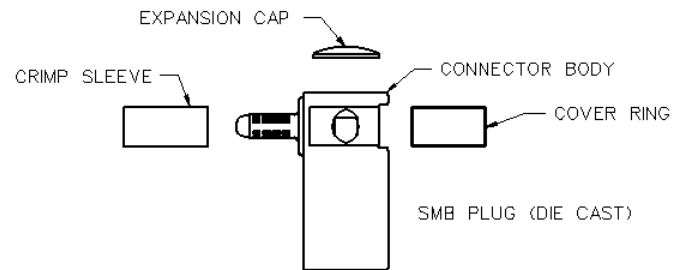
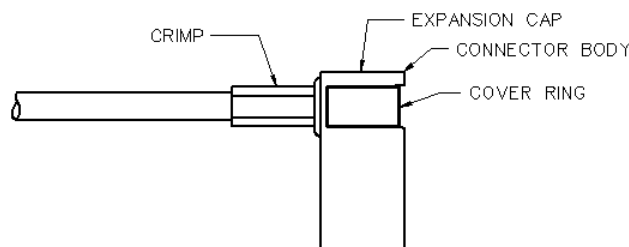
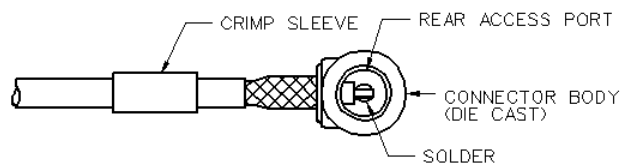
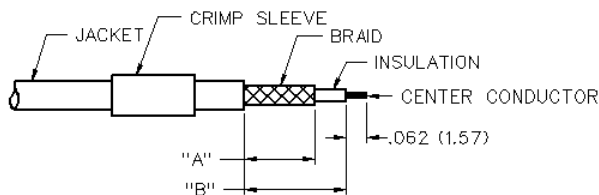

Mini-75 Ohm SMB Connectors



Specifications

INCHES (MILLIMETERS)
CUSTOMER DRAWINGS AVAILABLE UPON REQUEST

ELECTRICAL RATINGS

Impedance: 75 ohms

Frequency Range: 0-2 GHz

VSWR: f = GHz

RG-179, RG-59, Belden 735A cable:

Straight cabled connectors	1.25 + .04f
Right angle cabled connectors	1.35 + .04f
Adapters	1.20 + .04f
Type N Adapters	1.05 + .01f
Matching pad 50 ohm/75 ohm	1.05 + .1f
Loads	1.05 + .01f
Uncabled receptacles, opens, shorts	N/A

Working Voltage: (Vrms maximum)†

Connectors for Cable Type	Sea Level	70K Feet
RG-179, RG-59, Belden 735A, uncabled receptacles, adapters	335	85
Open, shorts, loads, matching pad	N/A	N/A

Dielectric Withstanding Voltage: (VRMS minimum at sea level)†

Connectors for RG-179, RG-59, Belden 735A, uncabled receptacles, adapters	1000
Open, shorts, loads, matching pad	N/A

Corona Level: (Volts minimum at 70,000 feet)†

Connectors for RG-179, RG-59, Belden 735A	250
Uncabled receptacles, adapters, open, shorts, loads, matching pad:	N/A

Electrical Length: Open ± 1.5° (± 5.2° relative to short)

Short ± 1.5° (± 5.2° relative to open)

Adapters ± 5.2° (N/A for Jack-Bulkhead Jack and N Types)

Insertion Loss: (dB maximum, tested at 1.5 GHz)

Straight cable connectors	0.30 dB
Right angle cable connectors	0.60 dB
Matching pad	6 dB nominal
Uncabled receptacles, adapters, opens, shorts, loads	N/A

Insulation Resistance: 1000 megohms minimum

Contact Resistance: (milliohms maximum)	Initial	After Environmental
Center contact (straight cabled connectors, uncabled receptacles, opens, shorts, loads)	6.0	8.0
Center contact (right angle cabled connectors and adapters)	12.0	16.0
Outer contact (gold plated connectors)	1.0	1.5
Outer contact (nickel plated connectors)	2.5	3.5
Braid to body (gold plated connectors)	1.0	N/A
Braid to body (nickel plated connectors)	2.5	N/A

RF Leakage: (dB minimum tested at 2.5 GHz)

Cable connectors	-55 dB
Uncabled receptacles, adapters opens, shorts, loads, matching pad	N/A

RF High Potential Withstanding Voltage: (Vrms minimum, tested at 4 and 7 MHz)†

Connectors for RG-179, RG-59, Belden 735A	700
Uncabled receptacles and adapters	600
Opens, shorts, loads, matching pad	N/A

Power Rating: (Loads and matching pad only) 1.0 watt at +25°C derated linearly to .5 watt at +125°C

MECHANICAL RATINGS

Engagement Design: MIL-C-39012, Series SMB

Engagement/Disengagement Force: 2 pounds minimum to 14 pounds maximum axial force

Contact Retention: 4 lbs. minimum axial force (captivated contacts)

1 inch-ounce minimum torque (uncabled receptacles)

Cable Retention:

	Axial Force* (pounds)	Torque (in-oz)
--	--------------------------	-------------------

Connectors for RG-179, Belden 735A	20	N/A
Connectors for RG-59	40	N/A

* or cable breaking strength whichever is less.

Durability: 500 cycles minimum

ENVIRONMENTAL RATINGS (Meets or exceed the applicable paragraph of MIL-C-39012)

Temperature Range: - 65°C to +165°C -- Connectors and adapters

- 65°C to +125°C -- Loads, matching pad

20°C to 26°C -- Opens, shorts

Thermal Shock: MIL-STD-202, Method 107, Condition B

(N/A opens, shorts, loads, matching pad)

Corrosion: MIL-STD-202, Method 101, Condition B

(N/A opens, shorts, loads, matching pad)

Shock: MIL-STD-210, Method 213, Condition B

(N/A opens, shorts, loads, matching pad)

Vibration: MIL-STD-202, Method 204, Condition B

(N/A opens, shorts, loads, matching pad)

Temperature Coefficient: (Loads only) ± 300 ppm/°C

MATERIAL SPECIFICATIONS

Bodies: Brass per QQ-B-626, gold plated** per MIL-G-45204 .00001" min. or nickel plated per QQ-N-290

N type adapters stainless steel per QQ-S-763, passivated per MIL-F-14072

Contacts: Male & Female - beryllium copper per QQ-C-530, gold plated per MIL-G-45204 .00003" min.

Insulators: PTFE fluorocarbon per ASTM D 1710 and ASTM D 1457

Expansion Caps: Brass per QQ-B-613, gold plated per MIL-G-45204 .00001" min. or nickel plated per QQ-N-290

Crimp Sleeves: Copper per WW-T-799, gold plated per MIL-G-45204 .00001" min. or nickel plated per QQ-N-290

Mounting Hardware: Brass (nuts) per QQ-B-626 or phosphor bronze (lockwashers) QQ-B-750, gold plated per MIL-G-45204 .00001" min. or nickel plated per QQ-N-290

** All gold plated parts include a .00005" min. nickel underplate barrier layer.

Avoid user injury due to misapplication. See safety advisory definitions inside front cover.

MATING ENGAGEMENT FOR MINI-75 OHM SMB SERIES (INTERMATEABLE WITH STANDARD 50 OHM SMB)

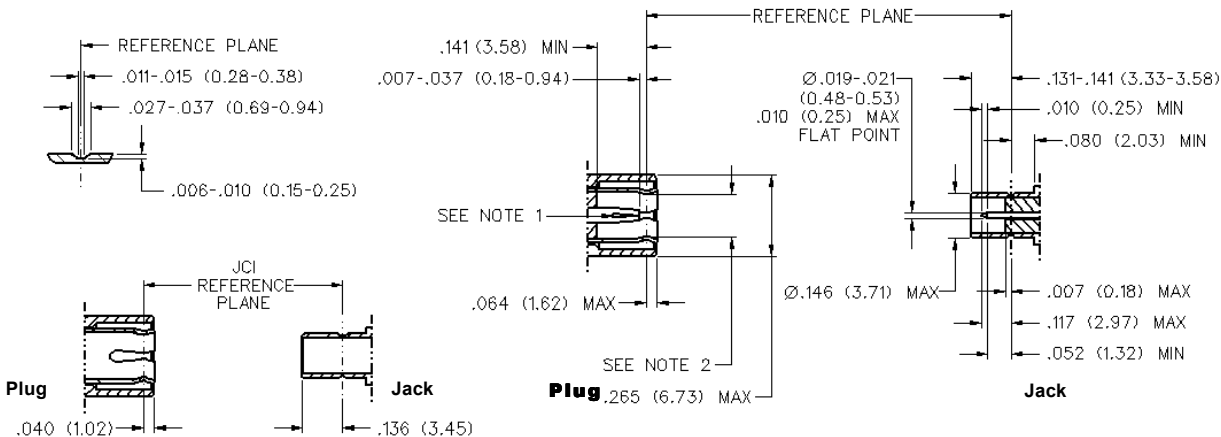

NOTES:

1. ID of contact to meet VSWR, mating characteristics and connector durability when mated with a dia .019-.021 (0.48/0.53) male contact.
2. Must meet the force to engage and disengage when mated with mating part.