



## GaAs MMIC SP4T REFLECTIVE SWITCH, 23 - 30 GHz

### Typical Applications

The HMC944LC4 is ideal for:

- Telecom Infrastructure
- Microwave Radio & VSAT
- Military & Space Hybrids
- Test Instrumentation
- SATCOM & Sensors

### Functional Diagram

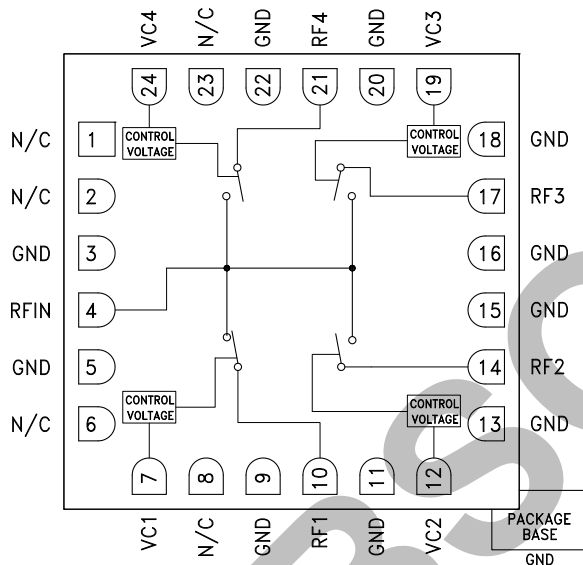

### Features

- Broadband Performance: 23 - 30 GHz
- High Isolation: 35 dB
- Insertion Loss: 2.8 dB
- 24 Lead 4x4mm SMT Package: 16mm<sup>2</sup>

### General Description

The HMC944LC4 is a broadband reflective GaAs MESFET SP4T switch in a compact 4x4 mm ceramic package. Covering 23 to 30 GHz, this switch offers high isolation and low insertion loss. The HMC944LC4 is controlled with 0/ -3V logic, exhibits fast switching speed and consumes much less DC current than pin diode based solutions. With its compact form factor, the HMC944LC4 is ideal for microwave radio as well as SATCOM and sensor applications. The HMC944LC4 is housed in a leadless 4x4 mm SMT package which is compatible with surface mount manufacturing techniques.

### Electrical Specifications, $T_A = +25^\circ C$ , With 0/-3V Control, 50 Ohm System

Parameter	Frequency	Min.	Typ.	Max.	Units
Insertion Loss	(RFC to RF1, RF4)	23 - 30 GHz	2.8	4	dB
	(RFC to RF2, RF3)		3.5	5	
Isolation (RFIN to RF1 - RF4)	23 - 30 GHz	30	35		dB
Return Loss [1]	"On State"	23 - 30 GHz	10		dB
Return Loss [2]	"Off State"	23 - 30 GHz	4		dB
Input Power for 0.1 dB Compression	23 - 30 GHz		17		dBm
Input Third Order Intercept (Two-Tone Input Power= 0 dBm Each Tone)	23 - 30 GHz		30		dBm
Switching Characteristics	tRISE, tFALL (10/90% RF)	23 - 30 GHz	15		ns
	tON, tOFF (50% CTL to 10/90% RF)	23 - 30 GHz	53		ns

[1] Return loss with switch path in insertion loss state.

[2] Return loss with switch path in isolation state.



**GaAs MMIC SP4T REFLECTIVE SWITCH, 23 - 30 GHz**

**Insertion Loss RFIN to RF1, RF4 vs. Temperature**

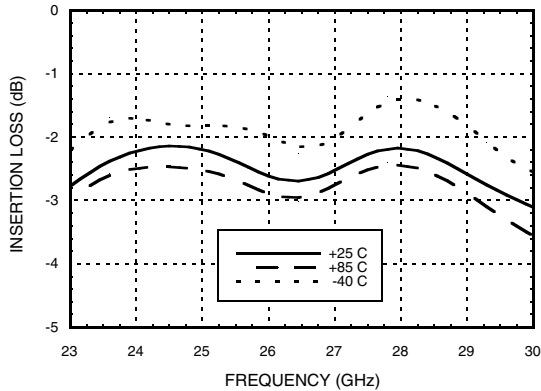

**Insertion Loss RFIN to RF2, RF3 vs. Temperature**

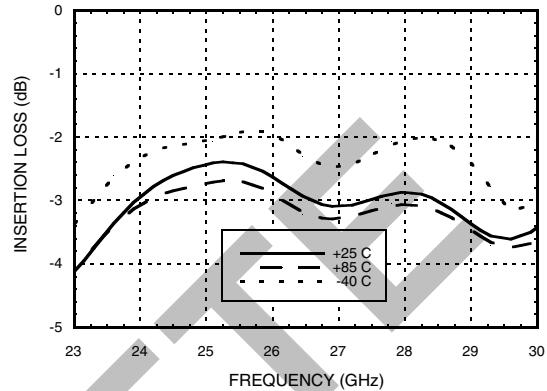

**Isolation [1]**

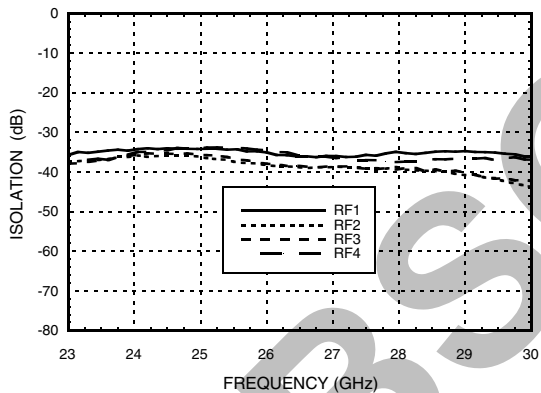

**Return Loss On State [2]**

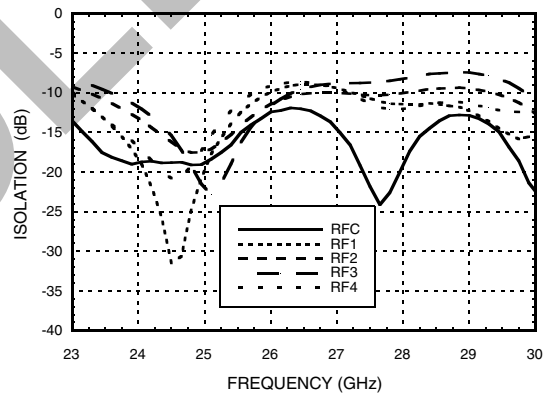

**Return Loss Off State**

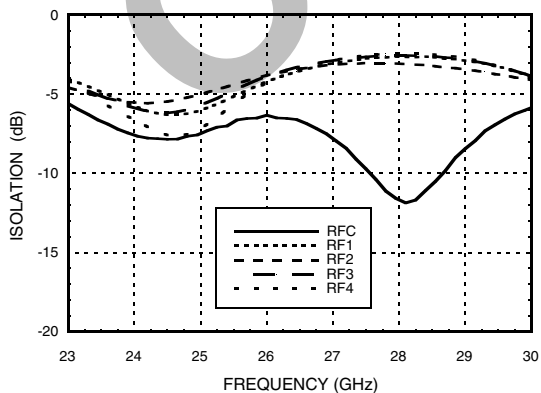

**0.1 dB Input Compression Point**

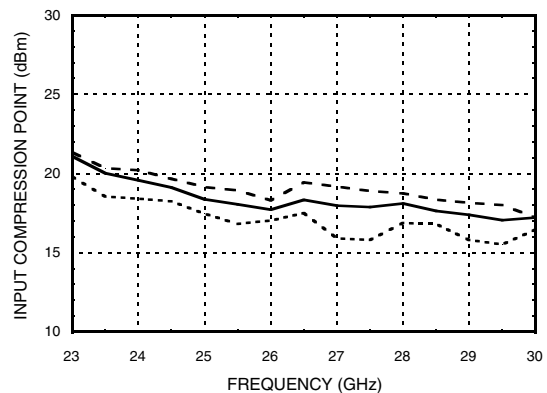

[1] Return loss with switch path in insertion loss state.  
 [2] Return loss with switch path in isolation state.

**GaAs MMIC SP4T REFLECTIVE  
SWITCH, 23 - 30 GHz**
**Absolute Maximum Ratings**

Control Voltage Range (VC1, VC2, VC3, VC4)	<+2V and >-5V
Maximum Input Power	2W (33 dBm)
Channel Temperature	150 °C
Thermal Resistance Channel to die bottom (Insertion Loss Path)	12 °C/W
Storage Temperature	-65 to +150 °C
Operating Temperature	-40 to +85 °C
ESD Sensitivity (HBM)	Class 1B



**ELECTROSTATIC SENSITIVE DEVICE  
OBSERVE HANDLING PRECAUTIONS**

**Bias Voltage & Current**

VC (V)	IC (µA)
VC1 = -3V	IC1 <10 µA
VC2 = -3V	IC2 <10 µA
VC3 = -3V	IC3 <10 µA
VC4 = -3V	IC4 <10 µA

**Truth Table**

VC1	VC2	VC3	VC4	RFIN to:
-3V	0V	0V	0V	RF1
0V	-3V	0V	0V	RF2
0V	0V	-3V	0V	RF3
0V	0V	0V	-3V	RF4

**Control Voltages**

State	Bias Condition
Low	+1V to -0.25V
High	-2.7V to -5V, < 10 µA

OBSOLETE



**GaAs MMIC SP4T REFLECTIVE  
SWITCH, 23 - 30 GHz**

**Outline Drawing**

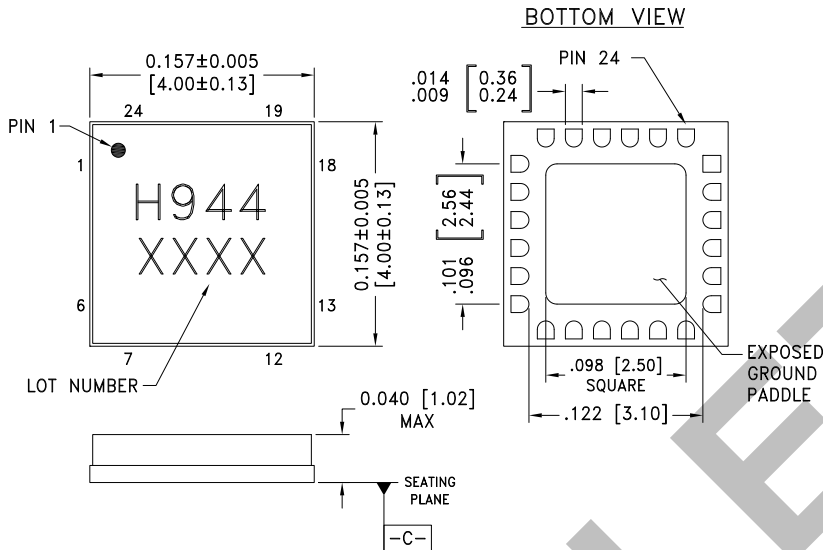

**NOTES:**

1. PACKAGE BODY MATERIAL: ALUMINA
2. LEAD AND GROUND PADDLE PLATING: 30-80 MICROINCHES GOLD OVER 50 MICROINCHES MINIMUM NICKEL.
3. DIMENSIONS ARE IN INCHES [MILLIMETERS].
4. LEAD SPACING TOLERANCE IS NON-CUMULATIVE
5. PACKAGE WARP SHALL NOT EXCEED 0.05mm DATUM -C-
6. ALL GROUND LEADS AND GROUND PADDLE MUST BE SOLDERED TO PCB RF GROUND.



**Package Information**

Part Number	Package Body Material	Lead Finish	MSL Rating	Package Marking <sup>[2]</sup>
HMC944LC4	Alumina, White	Gold over Nickel	MSL3 <sup>[1]</sup>	H944 XXXX

[1] Max peak reflow temperature of 260 °C

[2] 4-Digit lot number XXXX

**GaAs MMIC SP4T REFLECTIVE  
SWITCH, 23 - 30 GHz**
**Pin Descriptions**

Pin Number	Function	Description	Interface Schematic
1, 2, 6, 8, 23	N/C	These pins are not connected internally; however, all data shown herein was measured with these pins connected to RF/DC ground externally.	
3, 5, 9, 11, 13, 15, 16, 18, 20, 22	GND	These pins and the exposed ground paddle must be connected to RF/DC ground.	
4, 10, 14, 17, 21	RIN, RF1, RF2, RF3, RF4	These pads are DC coupled (to GND) and matched to 50 Ohms.	
7, 12, 19, 24	VC1, VC2, VC3, VC4	See Truth Table	

OBSOLETE



**GaAs MMIC SP4T REFLECTIVE  
SWITCH, 23 - 30 GHz**

**Evaluation PCB**

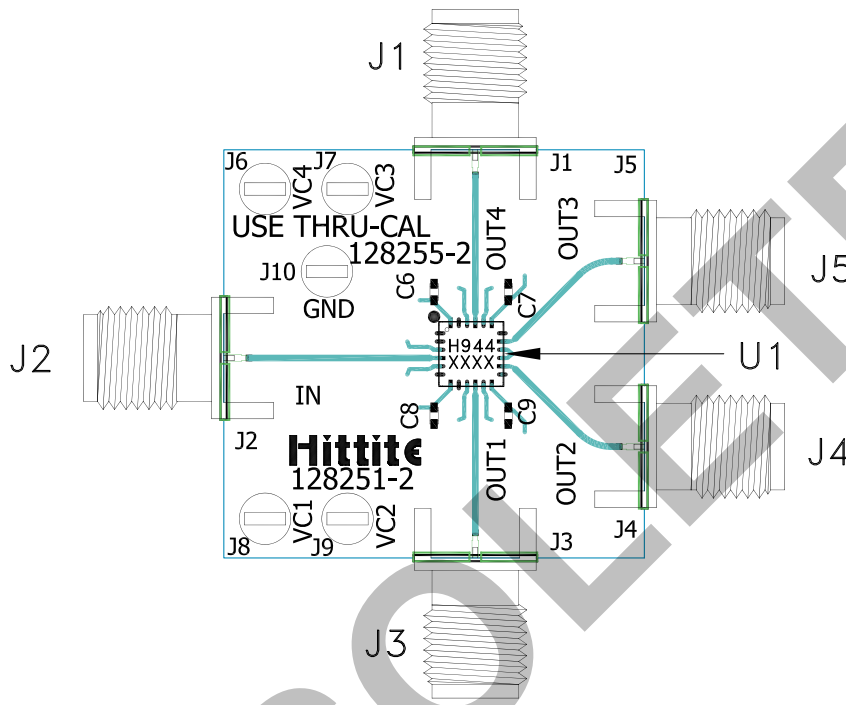

**List of Materials for Evaluation PCB 128253 [1]**

Item	Description
J1 - J5	PCB Mount K Connector
C6 - C9	1000 pF Capacitor, 0402 Pkg.
U1	HMC944LC4 Switch
PCB [2]	128251 Evaluation PCB

[1] Reference this number when ordering complete evaluation PCB

[2] Circuit Board Material: Rogers 4350 or Arlon FR4

The circuit board used in the application should use RF circuit design techniques. Signal lines should have 50 Ohm impedance while the package ground leads and exposed paddle should be connected directly to the ground plane similar to that shown. A sufficient number of via holes should be used to connect the top and bottom ground planes. The evaluation board should be mounted to an appropriate heat sink. The evaluation circuit board shown is available from Hittite upon request.