



HiPerFRED

V_{RRM}	=	600 V
I_{FAV}	=	30 A
t_{rr}	=	35 ns

High Performance Fast Recovery Diode
Low Loss and Soft Recovery
Single Diode

Part number

DSEP30-06A

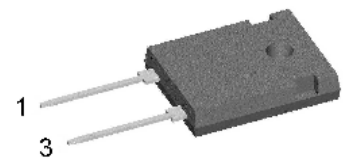

Backside: cathode

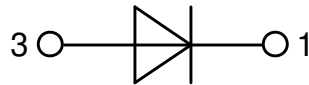

Features / Advantages:

- Planar passivated chips
- Very low leakage current
- Very short recovery time
- Improved thermal behaviour
- Very low I_{rm} -values
- Very soft recovery behaviour
- Avalanche voltage rated for reliable operation
- Soft reverse recovery for low EMI/RFI
- Low I_{rm} reduces:
 - Power dissipation within the diode
 - Turn-on loss in the commutating switch

Applications:

- Antiparallel diode for high frequency switching devices
- Antisaturation diode
- Snubber diode
- Free wheeling diode
- Rectifiers in switch mode power supplies (SMPS)
- Uninterruptible power supplies (UPS)

Package: TO-247

- Industry standard outline
- RoHS compliant
- Epoxy meets UL 94V-0

Disclaimer Notice

Information furnished is believed to be accurate and reliable. However, users should independently evaluate the suitability of and test each product selected for their own applications. Littelfuse products are not designed for, and may not be used in, all applications. Read complete Disclaimer Notice at www.littelfuse.com/disclaimer-electronics.



Fast Diode				Ratings			
Symbol	Definition	Conditions	min.	typ.	max.	Unit	
V_{RSM}	max. non-repetitive reverse blocking voltage	$T_{VJ} = 25^{\circ}C$			600	V	
V_{RRM}	max. repetitive reverse blocking voltage	$T_{VJ} = 25^{\circ}C$			600	V	
I_R	reverse current, drain current	$V_R = 600 V$	$T_{VJ} = 25^{\circ}C$		250	μA	
		$V_R = 600 V$	$T_{VJ} = 150^{\circ}C$		1	mA	
V_F	forward voltage drop	$I_F = 30 A$	$T_{VJ} = 25^{\circ}C$		1.60	V	
		$I_F = 60 A$			1.91	V	
		$I_F = 30 A$	$T_{VJ} = 150^{\circ}C$		1.25	V	
		$I_F = 60 A$			1.52	V	
I_{FAV}	average forward current	$T_C = 135^{\circ}C$ rectangular $d = 0.5$	$T_{VJ} = 175^{\circ}C$		30	A	
V_{FO}	threshold voltage	} for power loss calculation only	$T_{VJ} = 175^{\circ}C$		0.91	V	
r_F	slope resistance				8.7	m Ω	
R_{thJC}	thermal resistance junction to case				0.9	K/W	
R_{thCH}	thermal resistance case to heatsink			0.25		K/W	
P_{tot}	total power dissipation		$T_C = 25^{\circ}C$		165	W	
I_{FSM}	max. forward surge current	$t = 10 \text{ ms}; (50 \text{ Hz}), \text{ sine}; V_R = 0 V$	$T_{VJ} = 45^{\circ}C$		250	A	
C_J	junction capacitance	$V_R = 400 V$ $f = 1 \text{ MHz}$	$T_{VJ} = 25^{\circ}C$		26	pF	
I_{RM}	max. reverse recovery current	} $I_F = 30 A; V_R = 300 V$ $-di_F/dt = 200 A/\mu s$	$T_{VJ} = 25^{\circ}C$		6	A	
			$T_{VJ} = 100^{\circ}C$		10	A	
t_{rr}	reverse recovery time		$T_{VJ} = 25^{\circ}C$		35	ns	
			$T_{VJ} = 100^{\circ}C$		100	ns	



Package TO-247			Ratings			
Symbol	Definition	Conditions	min.	typ.	max.	Unit
I_{RMS}	RMS current	per terminal			70	A
T_{VJ}	virtual junction temperature		-55		175	°C
T_{op}	operation temperature		-55		150	°C
T_{stg}	storage temperature		-55		150	°C
Weight				6		g
M_D	mounting torque		0.8		1.2	Nm
F_C	mounting force with clip		20		120	N

Product Marking

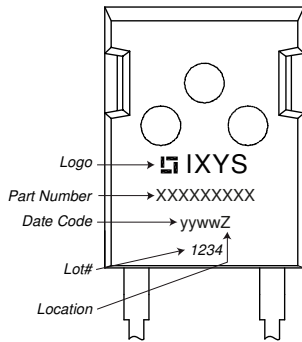

Ordering	Ordering Number	Marking on Product	Delivery Mode	Quantity	Code No.
Standard	DSEP30-06A	DSEP30-06A	Tube	30	471828

Similar Part	Package	Voltage class
DSEP29-06A	TO-220AC (2)	600
DSEP29-06AS	TO-263AB (D2Pak) (2)	600
DSEP30-06B	TO-247AD (2)	600
DSEP30-06BR	ISOPLUS247 (2)	600

DHG30I600HA	TO-247AD (2)	600
DHG30I600PA	TO-220AC (2)	600
DHG30IM600PC	TO-263AB (D2Pak) (2)	600

Equivalent Circuits for Simulation

* on die level

$T_{VJ} = 175^{\circ}\text{C}$

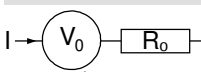

Fast Diode

$V_{0\ max}$ threshold voltage

0.91

V

$R_{0\ max}$ slope resistance *

6.1

mΩ



Outlines TO-247

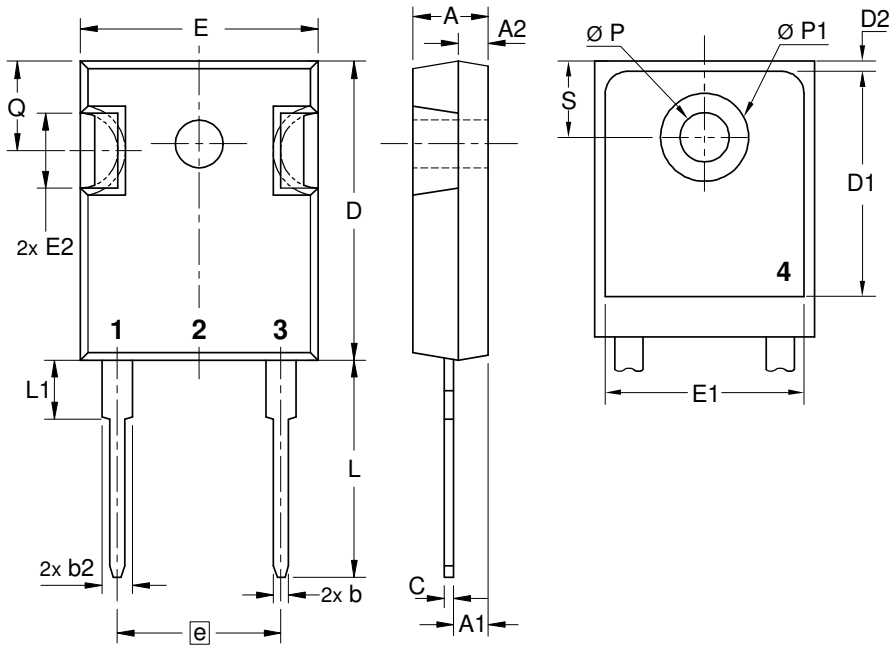

Sym.	Inches		Millimeter	
	min.	max.	min.	max.
A	0.185	0.209	4.70	5.30
A1	0.087	0.102	2.21	2.59
A2	0.059	0.098	1.50	2.49
D	0.819	0.845	20.79	21.45
E	0.610	0.640	15.48	16.24
E2	0.170	0.216	4.31	5.48
e	0.430 BSC		10.92 BSC	
L	0.780	0.800	19.80	20.30
L1	-	0.177	-	4.49
Ø P	0.140	0.144	3.55	3.65
Q	0.212	0.244	5.38	6.19
S	0.242 BSC		6.14 BSC	
b	0.039	0.055	0.99	1.40
b2	0.065	0.094	1.65	2.39
b4	0.102	0.135	2.59	3.43
c	0.015	0.035	0.38	0.89
D1	0.515	-	13.07	-
D2	0.020	0.053	0.51	1.35
E1	0.530	-	13.45	-
Ø P1	-	0.29	-	7.39



Fast Diode

 Fig. 1 Forward current I_F versus V_F

 Fig. 2 Typ. reverse recov. charge Q_r versus $-di_F/dt$

 Fig. 3 Typ. peak reverse current I_{RM} versus $-di_F/dt$

 Fig. 4 Dynamic parameters Q_r , I_{RM} versus T_{VJ}

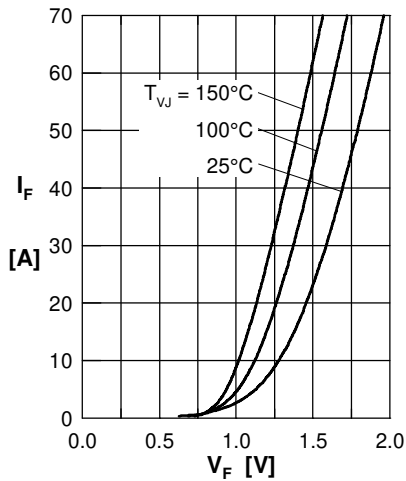
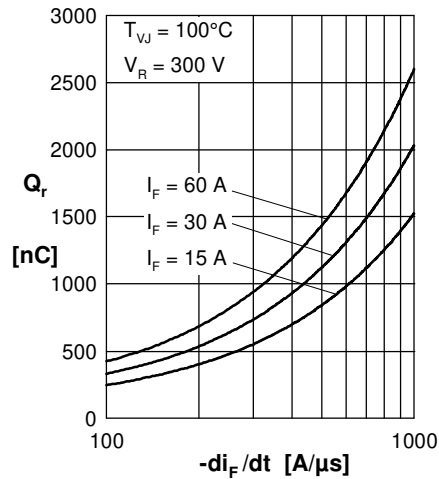
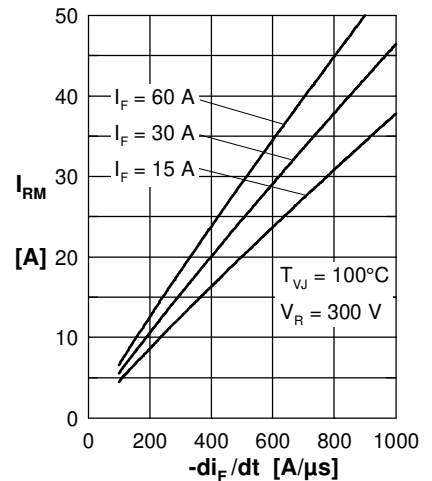
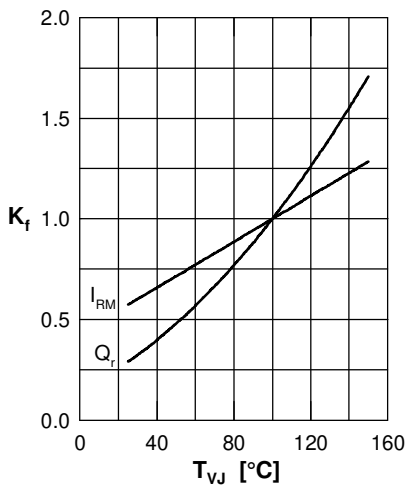
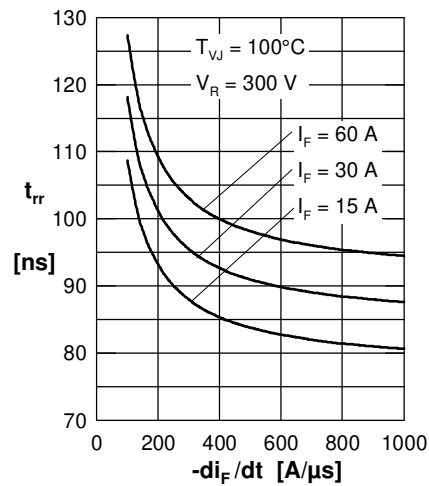
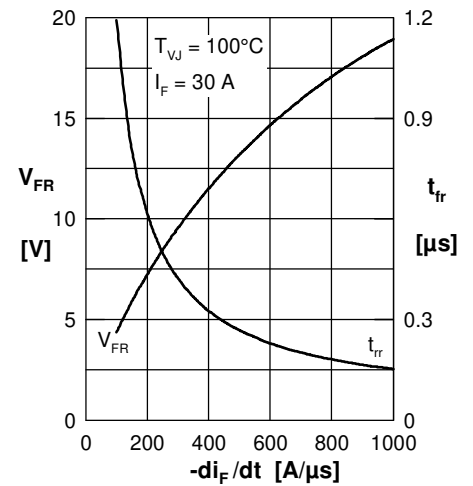
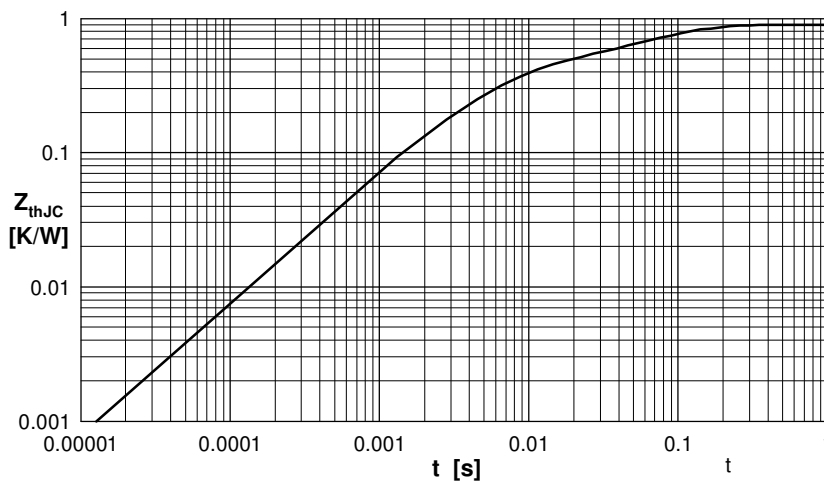
 Fig. 5 Typ. recovery time t_{tr} versus $-di_F/dt$

 Fig. 6 Typ. peak forward voltage V_{FR} and t_{tr} versus di_F/dt

Fig. 7 Transient thermal impedance junction to case

 Constants for Z_{thJC} calculation:

i	R_{thi} (K/W)	t_i (s)
1	0.030	0.001
2	0.080	0.030
3	0.300	0.006
4	0.490	0.060