

TPDxF003 Four-, Six-, and Eight-Channel EMI Filters With Integrated ESD Protection

1 Features

- Four-, Six-, and Eight-Channel EMI Filtering for Data Ports
- –3 dB Bandwidth of 200 MHz
- Greater than 25 dB attenuation at 1 GHz
- IEC 61000-4-2 Level 4 ESD Protection
 - ±12-kV Contact Discharge
 - ±20-kV Air Gap Discharge
- Pi-Style (C-R-C) Filter Configuration (R = 100 Ω, C_{TOTAL} = 17 pF)
- Low 10-nA Leakage Current
- Easy Flow-Through Routing

2 Applications

- Display Interfaces
- Cell Phones
- Tablets
- SVGA Video Connections
- Memory Interfaces

3 Description

The TPDxF003 family is a series of highly integrated devices designed to provide Electromagnetic Interference (EMI) filtering in all systems subjected to electromagnetic interference. These filters also provide a Transient Voltage Suppressor (TVS) diode circuit for Electrostatic Discharge (ESD) protection which prevents damage to the application when subjected to ESD stress far exceeding IEC 61000-4-2 (Level 4).

The TPDxF003 family is specified for –40°C to 85°C operation. These filters are also packaged in space-saving 0.4-mm pitch DQD packages.

Device Information⁽¹⁾

PART NUMBER	PACKAGE	BODY SIZE (NOM)
TPD4F003	WSON (8)	1.70 mm x 1.35 mm
TPD6F003	WSON (12)	2.50 mm x 1.35 mm
TPD8F003	WSON (16)	3.30 mm x 1.35 mm

(1) For all available packages, see the orderable addendum at the end of the datasheet.

Equivalent Schematic

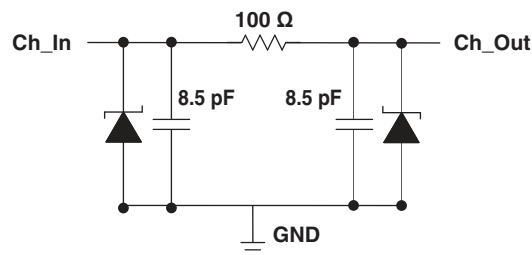

Table of Contents

1 Features	1	7.3 Feature Description	7
2 Applications	1	7.4 Device Functional Modes	8
3 Description	1	8 Applications and Implementation	9
4 Revision History	2	8.1 Application Information	9
5 Pin Configuration and Functions	3	8.2 Typical Application	9
6 Specifications	4	9 Power Supply Recommendations	11
6.1 Absolute Maximum Ratings	4	10 Layout	11
6.2 Handling Ratings	4	10.1 Layout Guidelines	11
6.3 Recommended Operating Conditions	4	10.2 Layout Example	11
6.4 Thermal Information	4	11 Device and Documentation Support	12
6.5 Electrical Characteristics	4	11.1 Related Links	12
6.6 Typical Characteristics	5	11.2 Trademarks	12
7 Detailed Description	7	11.3 Electrostatic Discharge Caution	12
7.1 Overview	7	11.4 Glossary	12
7.2 Functional Block Diagram	7	12 Mechanical, Packaging, and Orderable Information	12

4 Revision History

Changes from Revision D (January 2010) to Revision E

Page

- Added *Handling Rating* table, *Feature Description* section, *Device Functional Modes*, *Application and Implementation* section, *Power Supply Recommendations* section, *Layout* section, *Device and Documentation Support* section, and *Mechanical, Packaging, and Orderable Information* section **1**

5 Pin Configuration and Functions

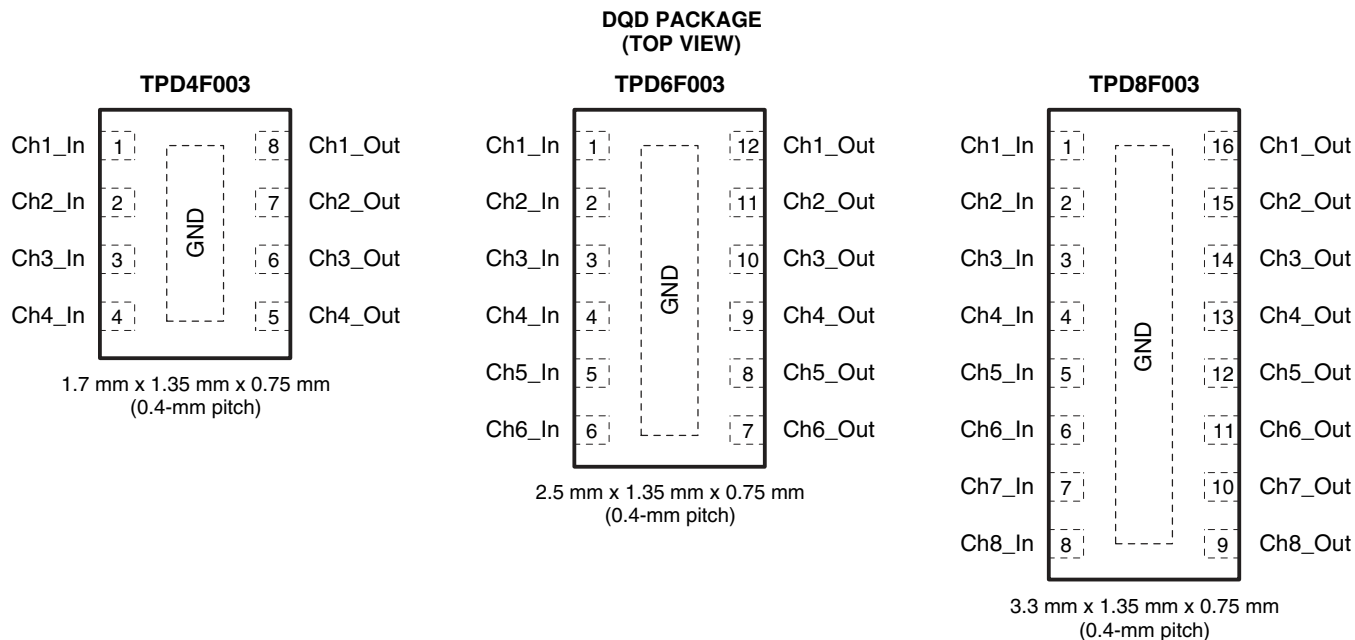

Pin Functions - TPD4F003

PIN		I/O	DESCRIPTION
NAME	No.		
ChX_In	1, 2, 3, 4	IO	ESD-protected channel, connected to corresponding ChX_Out
ChX_Out	5, 6, 7, 8	IO	ESD-protected channel, connected to corresponding ChX_In
GND	GND	G	Ground

Pin Functions - TPD6F003

PIN		I/O	Description
Name	No.		
ChX_In	1, 2, 3, 4, 5, 6	IO	ESD-protected channel, connected to corresponding ChX_Out
ChX_Out	7, 8, 9, 10, 11, 12	IO	ESD-protected channel, connected to corresponding ChX_In
GND	GND	G	Ground

Pin Functions - TPD8F003

PIN		I/O	Description
Name	No.		
ChX_In	1, 2, 3, 4, 5, 6, 7, 8	IO	ESD-protected channel, connected to corresponding ChX_Out
ChX_Out	9, 10, 11, 12, 13, 14, 15, 16	IO	ESD-protected channel, connected to corresponding ChX_In
GND	GND	G	Ground

6 Specifications

6.1 Absolute Maximum Ratings⁽¹⁾

over operating free-air temperature range (unless otherwise noted)

		MIN	MAX	UNIT
V _{IO}	IO to GND		6	V
T _J	Junction temperature		150	°C

- (1) Stresses beyond those listed under Absolute Maximum Ratings may cause permanent damage to the device. These are stress ratings only, and functional operation of the device at these or any other conditions beyond those indicated in the operational sections of the specifications is not implied. Exposure to absolute maximum rated conditions for extended periods may affect device reliability.

6.2 Handling Ratings

		MIN	MAX	UNIT	
T _{stg}	Storage temperature range	-65	150	°C	
V _(ESD)	Electrostatic discharge	Human body model (HBM), per ANSI/ESDA/JEDEC JS-001, all pins ⁽¹⁾		±15	kV
		Charged device model (CDM), per JEDEC specification JESD22-C101, all pins ⁽²⁾		±1500	V
		IEC 61000-4-2 ESD Rating - Contact		±12	kV
		IEC 61000-4-2 ESD Rating - Air		±20	

- (1) JEDEC document JEP155 states that 500-V HBM allows safe manufacturing with a standard ESD control process.
 (2) JEDEC document JEP157 states that 250-V CDM allows safe manufacturing with a standard ESD control process.

6.3 Recommended Operating Conditions

over operating free-air temperature range (unless otherwise noted)

	MIN	MAX	UNIT
V _{IO}	0	5.5	V
T _A	-40	85	°C

6.4 Thermal Information

THERMAL METRIC ⁽¹⁾		TPD4F003	TPD6F003	TPD8F003	UNIT
		DQD			
		8 PINS	12 PINS	16 PINS	
R _{θJA}	Junction-to-ambient thermal resistance	115.6	89.2	80.8	°C/W
R _{θJC(top)}	Junction-to-case (top) thermal resistance	108.5	100.1	88.3	
R _{θJB}	Junction-to-board thermal resistance	66.4	50.5	45.8	
ψ _{JT}	Junction-to-top characterization parameter	6.8	9.4	9.2	
ψ _{JB}	Junction-to-board characterization parameter	65.9	50.0	45.4	
R _{θJC(bot)}	Junction-to-case (bottom) thermal resistance	33.2	31.0	31.8	

- (1) For more information about traditional and new thermal metrics, see the *IC Package Thermal Metrics* application report, [SPRA953](#).

6.5 Electrical Characteristics

T_A = -40°C to 85°C (unless otherwise noted)

PARAMETER	TEST CONDITIONS	MIN	TYP ⁽¹⁾	MAX	UNIT	
V _{BR}	DC breakdown voltage	I _{IO} = 10 μA	6		V	
R	Resistance		85	100	115	Ω
C	Capacitance (C1 or C2)	V _{IO} = 2.5 V		8.5		pF
I _{IO}	Channel leakage current	V _{IO} = 3.3 V		10		nA
f _C	Cut-off frequency	Z _{SOURCE} = 50 Ω, Z _{LOAD} = 50 Ω		200		MHz

- (1) Typical values are at T_A = 25°C.

6.6 Typical Characteristics

6.6.1 IEC Clamping Waveforms (clamp voltage measured both at Ch_Out and Ch_In)

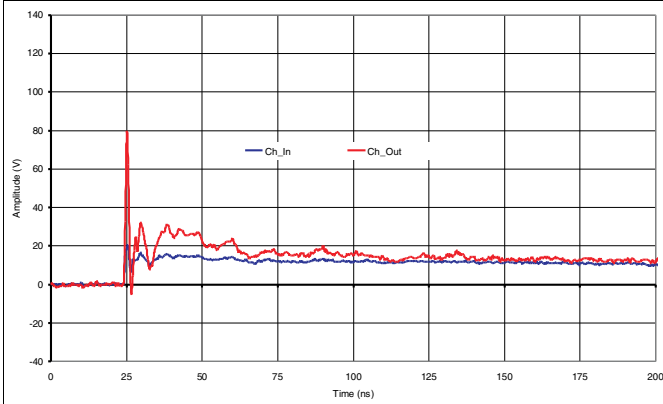

Figure 1. With 8 kV Contact ESD Stress at Ch_Out

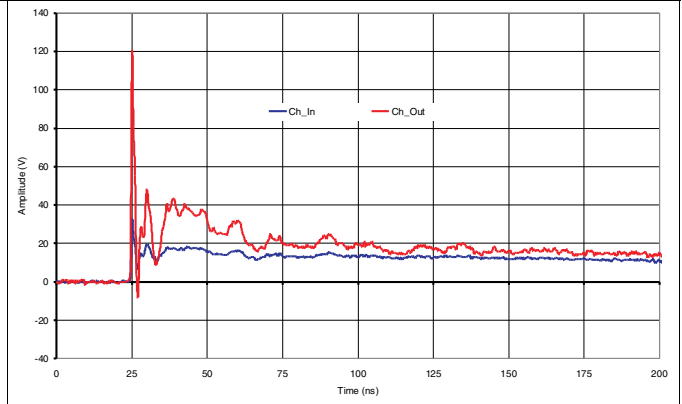

Figure 2. With 12 kV Contact ESD Stress at Ch_Out

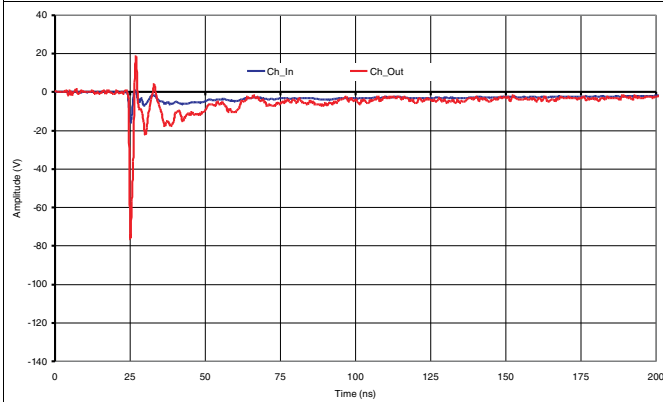

Figure 3. With -8 kV Contact ESD Stress at Ch_Out

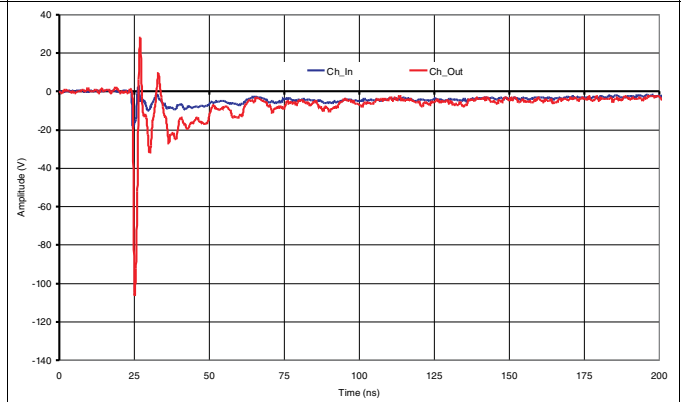

Figure 4. With -12 kV Contact ESD Stress at Ch_Out

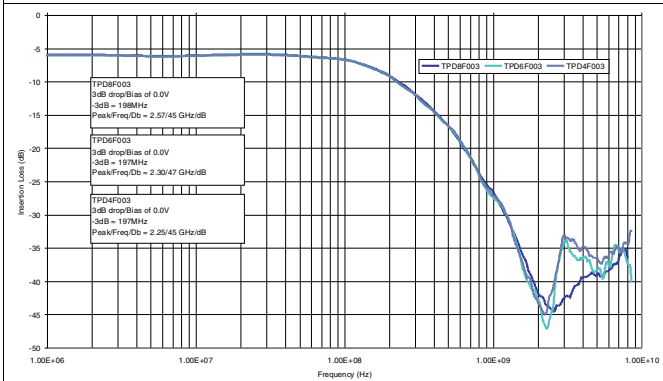

Figure 5. Frequency Response

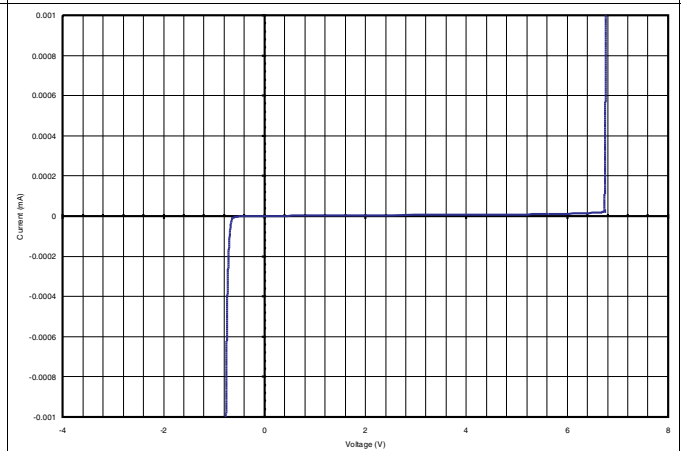

Figure 6. DC Voltage-Current Sweep Across Input/Output Pins

6.6.2 Channel-to-Channel Crosstalk

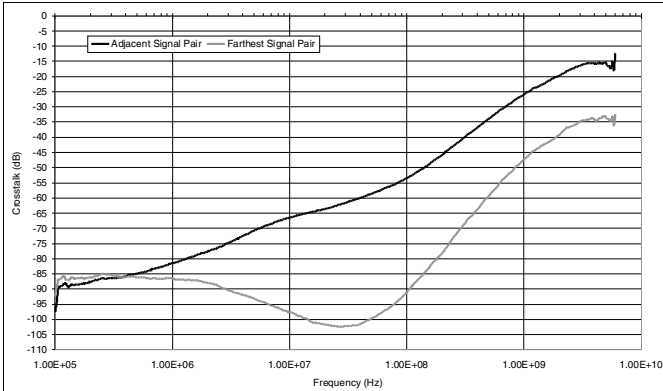

Figure 7. TPD4F003

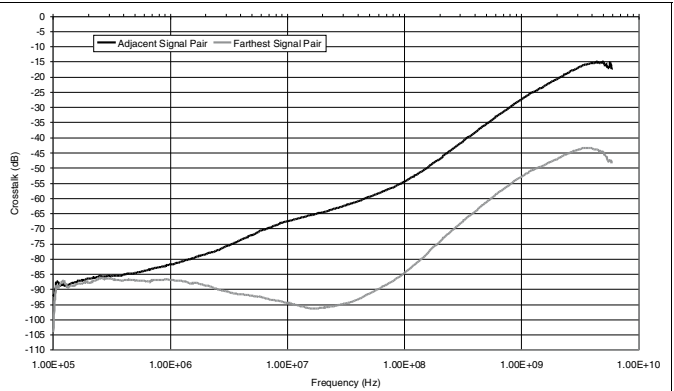

Figure 8. TPD6F003

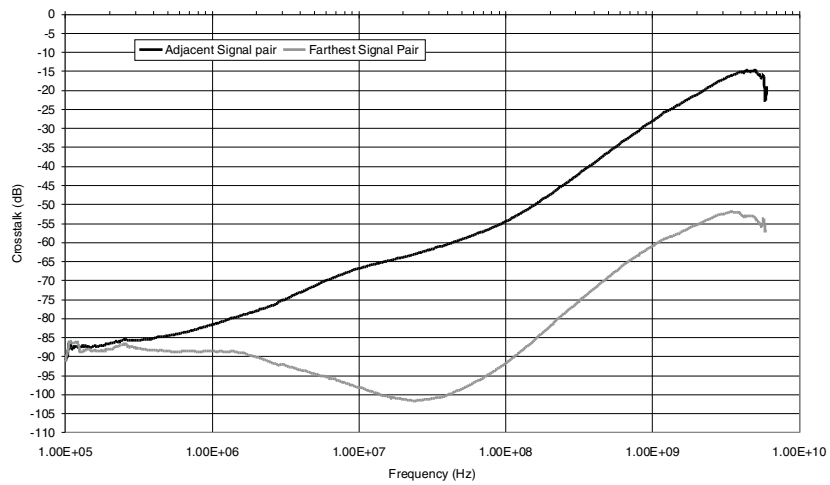

Figure 9. TPD8F003

7 Detailed Description

7.1 Overview

The TPDxF003 family is a series of highly integrated devices designed to provide EMI filtering in all systems subjected to electromagnetic interference. These filters also provide a Transient Voltage Suppressor (TVS) diode circuit for ESD protection which prevents damage to the application when subjected to ESD stress far exceeding IEC 61000-4-2 (Level 4).

7.2 Functional Block Diagram

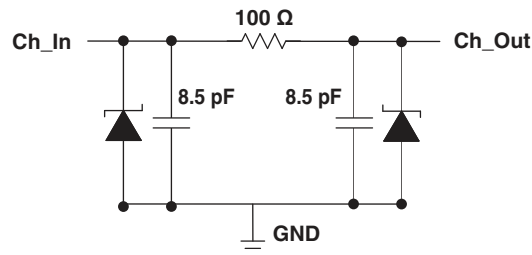

7.3 Feature Description

The TPDxF003 family is a line of ESD and EMI filtering devices designed to reduce EMI emissions and provide system level ESD protection. Each device can dissipate ESD strikes above the maximum level specified by IEC 61000-4-2 international standard. Additionally, the EMI filtering structure reduces EMI emissions by providing high frequency roll-off.

7.3.1 Four-, Six-, and Eight-Channel EMI Filtering for Data Ports

These devices provide EMI filtering for four, six, or eight channels of data lines.

7.3.2 –3 dB Bandwidth of 200 MHz

These devices have a through –3dB bandwidth of 200 MHz.

7.3.3 Greater Than 25 dB Attenuation at 1 GHz

Signal attenuation is above 25dB at 1 GHz, which provides significant reduction in spurious emissions.

7.3.4 Robust ESD Protection Exceeds IEC 61000-4-2

The ESD protection on all pins exceeds the IEC 61000-4-2 level 4 standard. Contact ESD is rated at ± 12 kV and Air-gap ESD is rated at ± 20 kV.

7.3.5 Pi-Style (C-R-C) Filter Configuration

This family of devices has a pi-style filtering configuration composed of a series resistor and two capacitors in parallel with the I/O pins. The typical resistor value is 100Ω and the typical capacitor values are 8.5 pF each.

7.3.6 Low 10-nA Leakage Current

The I/O pins feature an ultra-low leakage current of 10-nA (typical) with a bias of 3.3 V.

7.3.7 Easy Flow-Through Routing

The layout of this device makes it easy to add protection to existing layouts. The packages offer flow-through routing which requires minimal changes to existing layout for addition of these devices.

7.4 Device Functional Modes

The TPDxF003 family of devices are passive integrated circuits that passively filter EMI and trigger when voltages are above V_{BR} or below the lower diode voltage (-0.6 V). During ESD events, voltages as high as $\pm 20\text{ kV}$ (air) can be directed to ground via the internal diode network. Once the voltages on the protected line fall below the trigger levels, the device reverts to passive.

8 Applications and Implementation

8.1 Application Information

The TPDxF003 family are diode type TVS' integrated with series resistors for filtering emitted EMI. As signal passes through the device, higher frequency components are filtered out. This device also provides a path to ground during ESD events and isolates the protected IC. As the current from ESD passes through the TVS, only a small voltage drop is present across the diode. This is the voltage presented to the protected IC. In particular, these filters are ideal for EMI filtering and protecting data lines from ESD at the display, keypad, and memory interfaces.

8.2 Typical Application

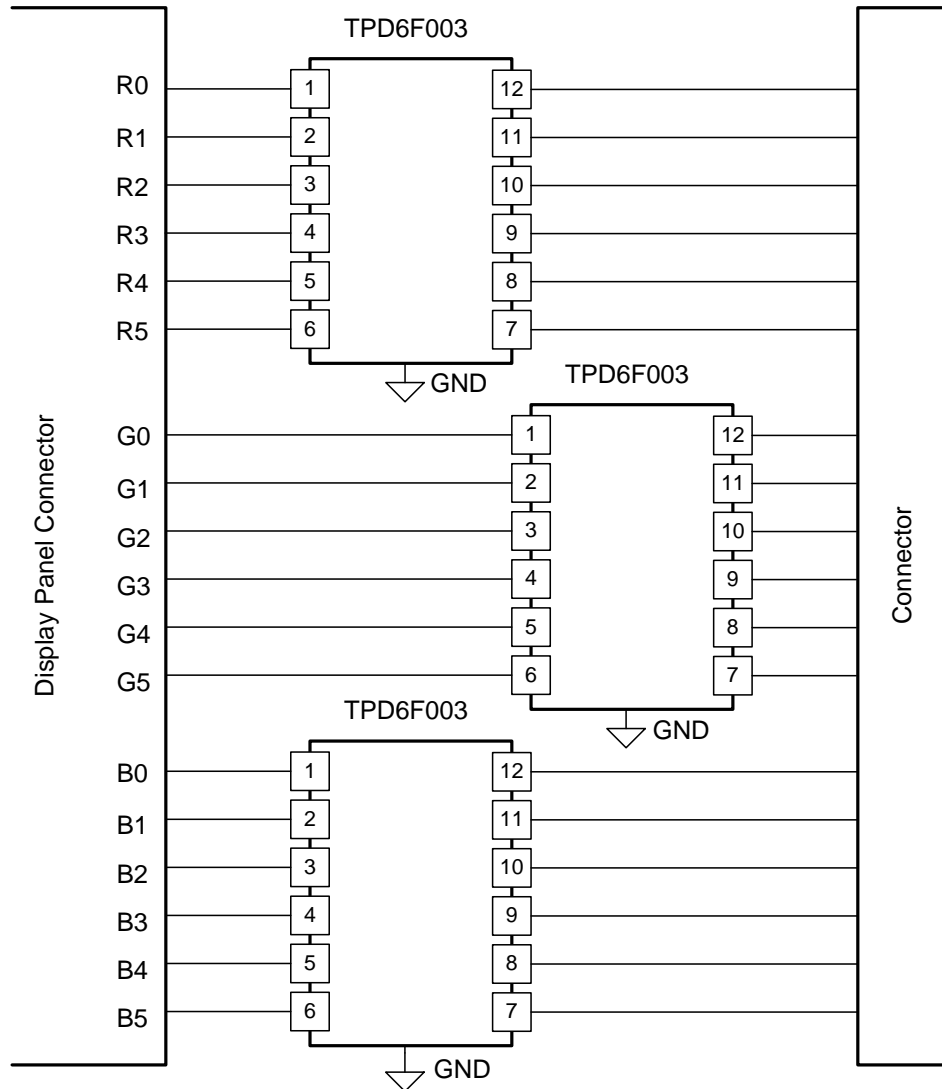

Figure 10. Display Panel Schematic

Typical Application (continued)

8.2.1 Design Requirements

For this design example, three TPD6F003 devices are used in an 18-bit display panel application. This will provide a complete ESD and EMI protection solution for the display connector.

Given the display panel application, the following parameters are known.

DESIGN PARAMETER	VALUE
Signal range on all pins except GND	0 V to 5 V
Operating Frequency	100 MHz

8.2.2 Detailed Design Procedure

To begin the design process, some design parameters must be decided; the designer need to know the following:

- Signal range on all the protected lines
- Operating frequency

8.2.2.1 Signal Range on All Protected Lines

The TPD6F003 has 8 identical protection channels for signal lines. All I/O pins will support a signal range from 0 to 5.5 V.

8.2.2.2 Operating Frequency

The TPD6F003 has a 200 MHz –3dB bandwidth, which supports the operating frequency for this display.

8.2.3 Application Curve

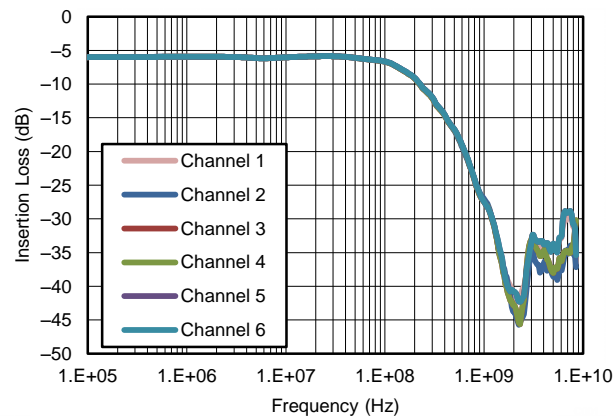

Figure 11. Frequency Response

9 Power Supply Recommendations

This family of devices are passive EMI and ESD devices so there is no need to power them. Care should be taken to not violate the recommended V_{IO} specification (5.5 V) to ensure the device functions properly.

10 Layout

10.1 Layout Guidelines

- The optimum placement is as close to the connector as possible.
 - EMI during an ESD event can couple from the trace being struck to other nearby unprotected traces, resulting in early system failures.
 - The PCB designer needs to minimize the possibility of EMI coupling by keeping any unprotected traces away from the protected traces which are between the TVS and the connector.
- Route the protected traces as straight as possible.
- Eliminate any sharp corners on the protected traces between the TVS and the connector by using rounded corners with the largest radii possible.
 - Electric fields tend to build up on corners, increasing EMI coupling.

10.2 Layout Example

This application is typical of an 18-bit RGB display panel layout.

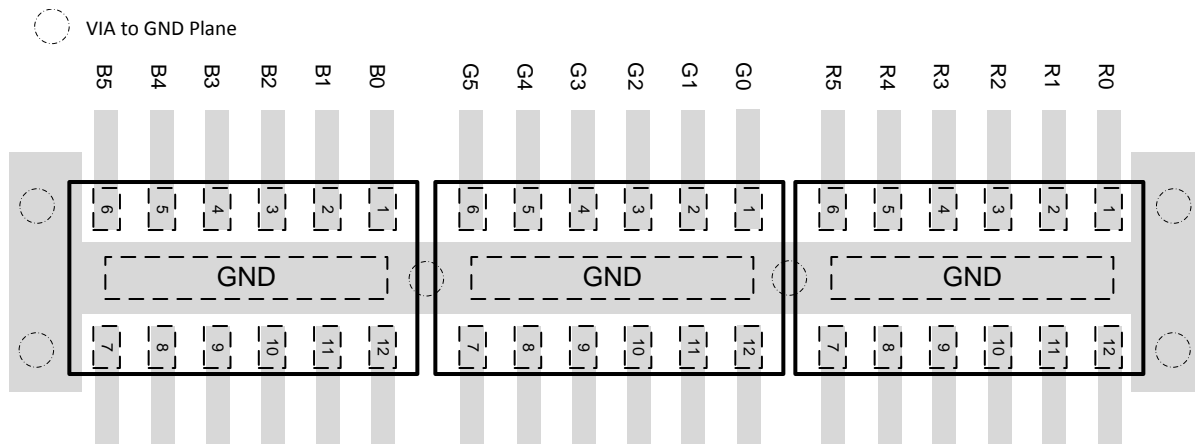

Figure 12. TPD6F003 Layout

11 Device and Documentation Support

11.1 Related Links

The table below lists quick access links. Categories include technical documents, support and community resources, tools and software, and quick access to sample or buy.

Table 1. Related Links

PARTS	PRODUCT FOLDER	SAMPLE & BUY	TECHNICAL DOCUMENTS	TOOLS & SOFTWARE	SUPPORT & COMMUNITY
TPD4F003	Click here	Click here	Click here	Click here	Click here
TPD6F003	Click here	Click here	Click here	Click here	Click here
TPD8F003	Click here	Click here	Click here	Click here	Click here

11.2 Trademarks

All trademarks are the property of their respective owners.

11.3 Electrostatic Discharge Caution



These devices have limited built-in ESD protection. The leads should be shorted together or the device placed in conductive foam during storage or handling to prevent electrostatic damage to the MOS gates.

11.4 Glossary

[SLYZ022](#) — *TI Glossary*.

This glossary lists and explains terms, acronyms, and definitions.

12 Mechanical, Packaging, and Orderable Information

The following pages include mechanical, packaging, and orderable information. This information is the most current data available for the designated devices. This data is subject to change without notice and revision of this document. For browser-based versions of this data sheet, refer to the left-hand navigation.

PACKAGING INFORMATION

Orderable Device	Status (1)	Package Type	Package Drawing	Pins	Package Qty	Eco Plan (2)	Lead finish/ Ball material (6)	MSL Peak Temp (3)	Op Temp (°C)	Device Marking (4/5)	Samples
TPD4F003DQDR	ACTIVE	WSON	DQD	8	3000	RoHS & Green	NIPDAUAG	Level-1-260C-UNLIM	-40 to 85	5RS	Samples
TPD6F003DQDR	ACTIVE	WSON	DQD	12	3000	RoHS & Green	NIPDAUAG	Level-1-260C-UNLIM	-40 to 85	47S	Samples
TPD8F003DQDR	ACTIVE	WSON	DQD	16	3000	RoHS & Green	NIPDAUAG	Level-1-260C-UNLIM	-40 to 85	(5US, 5UU)	Samples

(1) The marketing status values are defined as follows:

ACTIVE: Product device recommended for new designs.

LIFEBUY: TI has announced that the device will be discontinued, and a lifetime-buy period is in effect.

NRND: Not recommended for new designs. Device is in production to support existing customers, but TI does not recommend using this part in a new design.

PREVIEW: Device has been announced but is not in production. Samples may or may not be available.

OBSOLETE: TI has discontinued the production of the device.

(2) **RoHS:** TI defines "RoHS" to mean semiconductor products that are compliant with the current EU RoHS requirements for all 10 RoHS substances, including the requirement that RoHS substance do not exceed 0.1% by weight in homogeneous materials. Where designed to be soldered at high temperatures, "RoHS" products are suitable for use in specified lead-free processes. TI may reference these types of products as "Pb-Free".

RoHS Exempt: TI defines "RoHS Exempt" to mean products that contain lead but are compliant with EU RoHS pursuant to a specific EU RoHS exemption.

Green: TI defines "Green" to mean the content of Chlorine (Cl) and Bromine (Br) based flame retardants meet JS709B low halogen requirements of <=1000ppm threshold. Antimony trioxide based flame retardants must also meet the <=1000ppm threshold requirement.

(3) MSL, Peak Temp. - The Moisture Sensitivity Level rating according to the JEDEC industry standard classifications, and peak solder temperature.

(4) There may be additional marking, which relates to the logo, the lot trace code information, or the environmental category on the device.

(5) Multiple Device Markings will be inside parentheses. Only one Device Marking contained in parentheses and separated by a "~" will appear on a device. If a line is indented then it is a continuation of the previous line and the two combined represent the entire Device Marking for that device.

(6) Lead finish/Ball material - Orderable Devices may have multiple material finish options. Finish options are separated by a vertical ruled line. Lead finish/Ball material values may wrap to two lines if the finish value exceeds the maximum column width.

Important Information and Disclaimer:The information provided on this page represents TI's knowledge and belief as of the date that it is provided. TI bases its knowledge and belief on information provided by third parties, and makes no representation or warranty as to the accuracy of such information. Efforts are underway to better integrate information from third parties. TI has taken and continues to take reasonable steps to provide representative and accurate information but may not have conducted destructive testing or chemical analysis on incoming materials and chemicals. TI and TI suppliers consider certain information to be proprietary, and thus CAS numbers and other limited information may not be available for release.

In no event shall TI's liability arising out of such information exceed the total purchase price of the TI part(s) at issue in this document sold by TI to Customer on an annual basis.

TAPE AND REEL INFORMATION

QUADRANT ASSIGNMENTS FOR PIN 1 ORIENTATION IN TAPE

*All dimensions are nominal

Device	Package Type	Package Drawing	Pins	SPQ	Reel Diameter (mm)	Reel Width W1 (mm)	A0 (mm)	B0 (mm)	K0 (mm)	P1 (mm)	W (mm)	Pin1 Quadrant
TPD4F003DQDR	WSON	DQD	8	3000	180.0	8.4	1.65	2.0	0.95	4.0	8.0	Q1
TPD6F003DQDR	WSON	DQD	12	3000	180.0	8.4	1.68	2.79	0.91	4.0	8.0	Q1
TPD8F003DQDR	WSON	DQD	16	3000	330.0	12.4	1.65	3.6	0.95	4.0	12.0	Q1

TAPE AND REEL BOX DIMENSIONS

*All dimensions are nominal

Device	Package Type	Package Drawing	Pins	SPQ	Length (mm)	Width (mm)	Height (mm)
TPD4F003DQDR	WSON	DQD	8	3000	183.0	183.0	20.0
TPD6F003DQDR	WSON	DQD	12	3000	183.0	183.0	20.0
TPD8F003DQDR	WSON	DQD	16	3000	358.0	335.0	35.0

DQD (R-PWSON-N12)

PLASTIC SMALL OUTLINE NO-LEAD

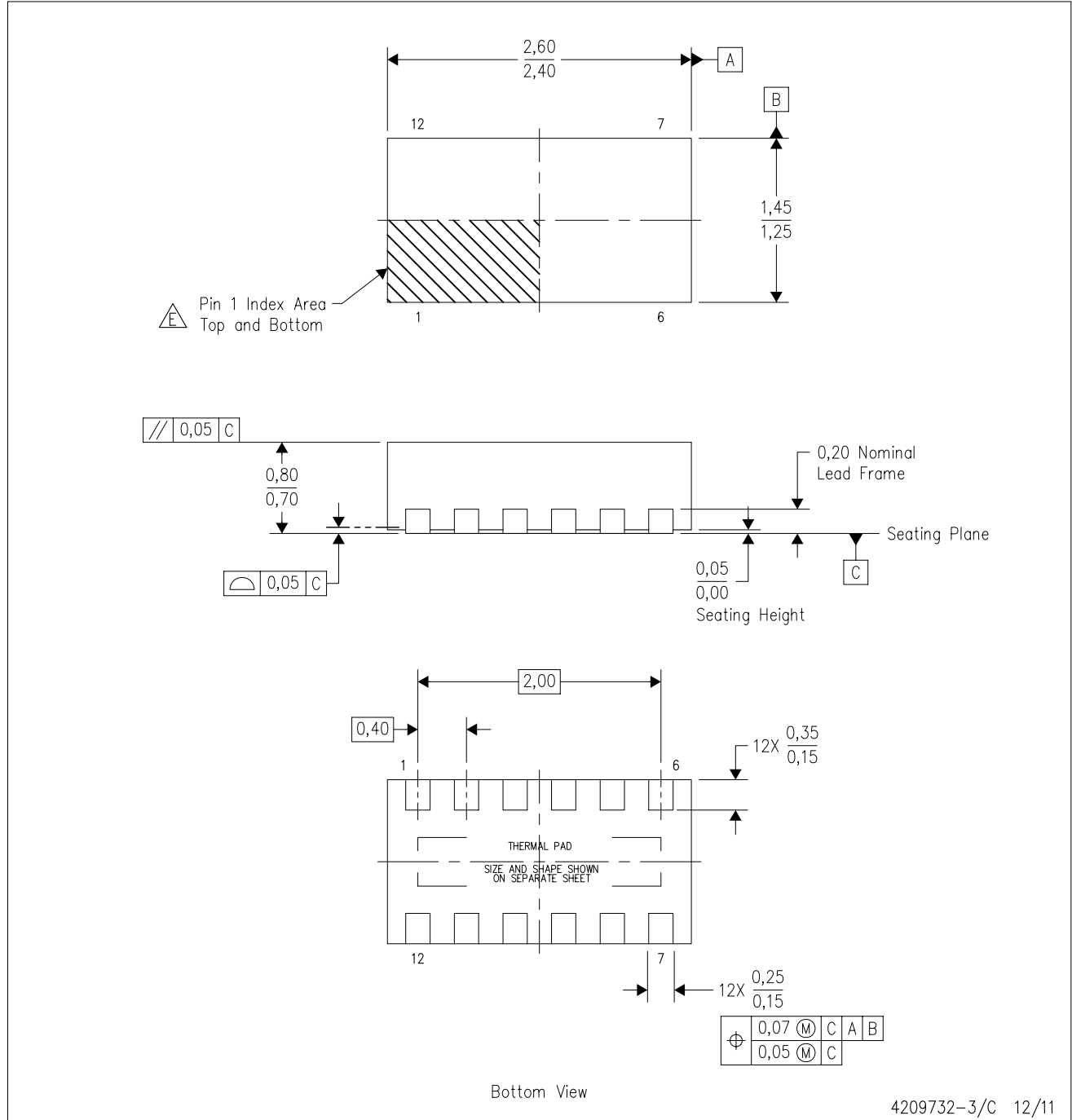

- NOTES:
- All linear dimensions are in millimeters. Dimensioning and tolerancing per ASME Y14.5M-1994.
 - This drawing is subject to change without notice.
 - SON (Small Outline No-Lead) package configuration.
 - The package thermal pad must be soldered to the board for thermal and mechanical performance.
 - See the additional figure in the Product Data Sheet for details regarding the exposed thermal pad features and dimensions.
- △ Pin 1 identifiers are located on both top and bottom of the package and within the zone indicated. The Pin 1 identifiers are either a molded, marked, or metal feature.

THERMAL PAD MECHANICAL DATA

DQD (R-PWSON-N12)

PLASTIC SMALL OUTLINE NO-LEAD

THERMAL INFORMATION

This package incorporates an exposed thermal pad that is designed to be attached directly to an external heatsink. The thermal pad must be soldered directly to the printed circuit board (PCB). After soldering, the PCB can be used as a heatsink. In addition, through the use of thermal vias, the thermal pad can be attached directly to the appropriate copper plane shown in the electrical schematic for the device, or alternatively, can be attached to a special heatsink structure designed into the PCB. This design optimizes the heat transfer from the integrated circuit (IC).

For information on the Quad Flatpack No-Lead (QFN) package and its advantages, refer to Application Report, QFN/SOIC PCB Attachment, Texas Instruments Literature No. SLUA271. This document is available at www.ti.com.

The exposed thermal pad dimensions for this package are shown in the following illustration.

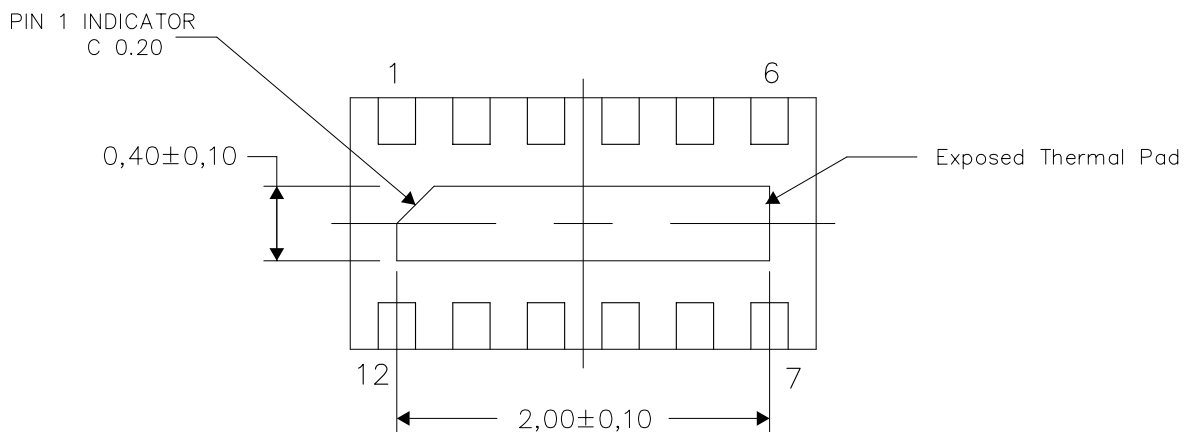

Bottom View

Exposed Thermal Pad Dimensions

4209733-3/C 12/11

NOTE: All linear dimensions are in millimeters

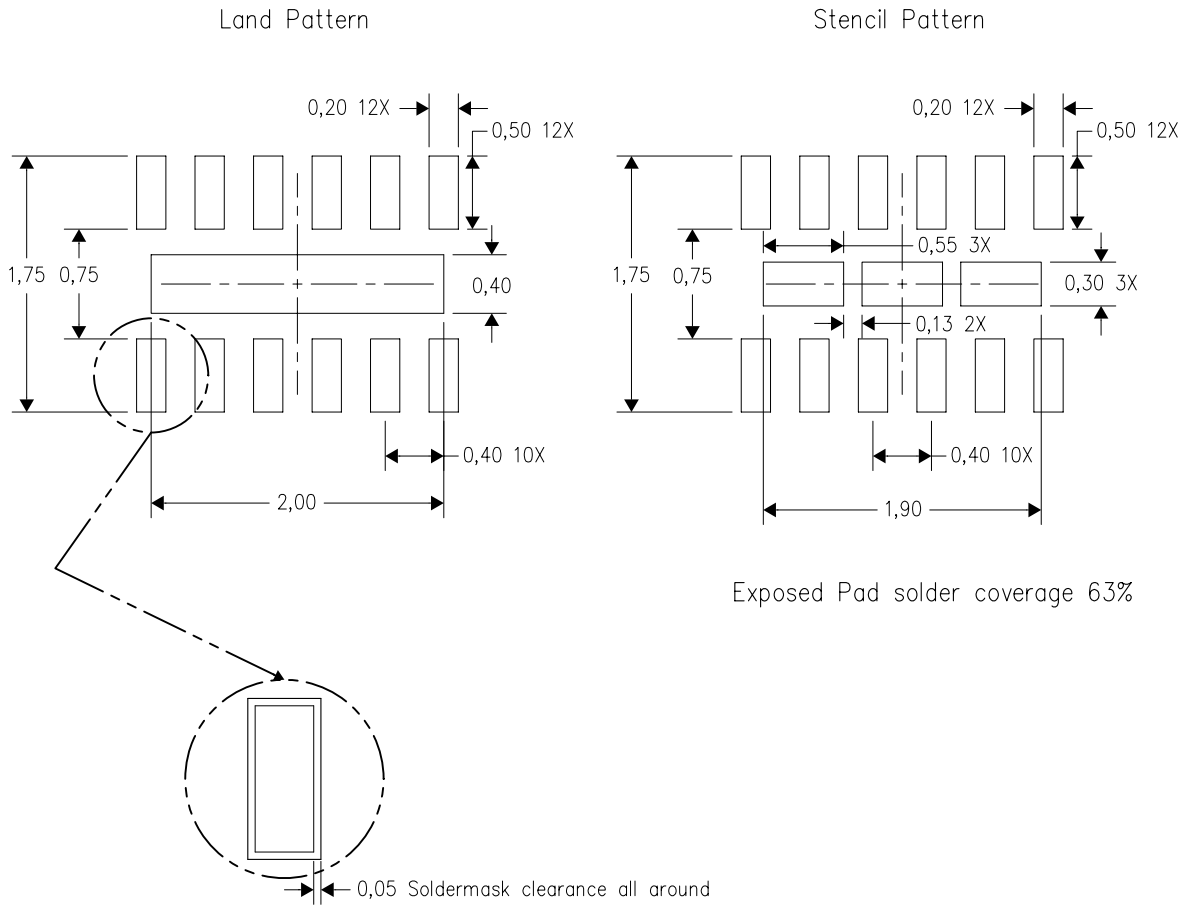

4211174-3/B 01/12

- NOTES:
- A. All linear dimensions are in millimeters.
 - B. This drawing is subject to change without notice.
 - C. Publication IPC-7351 is recommended for alternate designs.
 - D. Customers should contact their board fabrication site for minimum solder mask web tolerances between signal pads.
 - E. Maximum stencil thickness 0,1016 mm (4 mils). All linear dimensions are in millimeters.
 - F. Laser cutting apertures with trapezoidal walls and also rounding corners will offer better paste release. Customers should contact their board assembly site for stencil design recommendations. Refer to IPC 7525 for stencil design considerations.
 - G. Side aperture dimensions over-print land for acceptable area ratio > 0.66. Customer may reduce side aperture dimensions if stencil manufacturing process allows for sufficient release at smaller opening.

THERMAL PAD MECHANICAL DATA

DQD (R-PWSON-N16)

PLASTIC SMALL OUTLINE NO-LEAD

THERMAL INFORMATION

This package incorporates an exposed thermal pad that is designed to be attached directly to an external heatsink. The thermal pad must be soldered directly to the printed circuit board (PCB). After soldering, the PCB can be used as a heatsink. In addition, through the use of thermal vias, the thermal pad can be attached directly to the appropriate copper plane shown in the electrical schematic for the device, or alternatively, can be attached to a special heatsink structure designed into the PCB. This design optimizes the heat transfer from the integrated circuit (IC).

For information on the Quad Flatpack No-Lead (QFN) package and its advantages, refer to Application Report, QFN/SOIC PCB Attachment, Texas Instruments Literature No. SLUA271. This document is available at www.ti.com.

The exposed thermal pad dimensions for this package are shown in the following illustration.

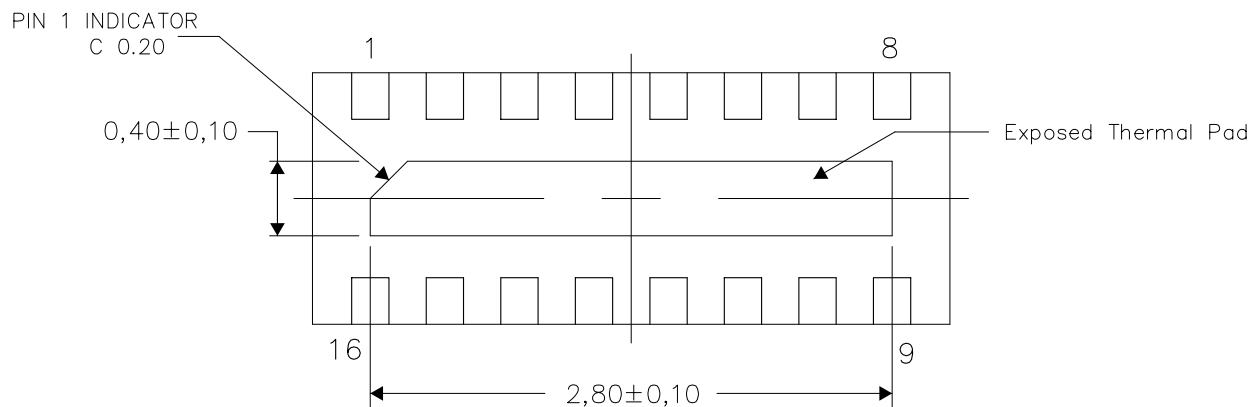

Bottom View

Exposed Thermal Pad Dimensions

4209733-4/C 12/11

NOTE: All linear dimensions are in millimeters

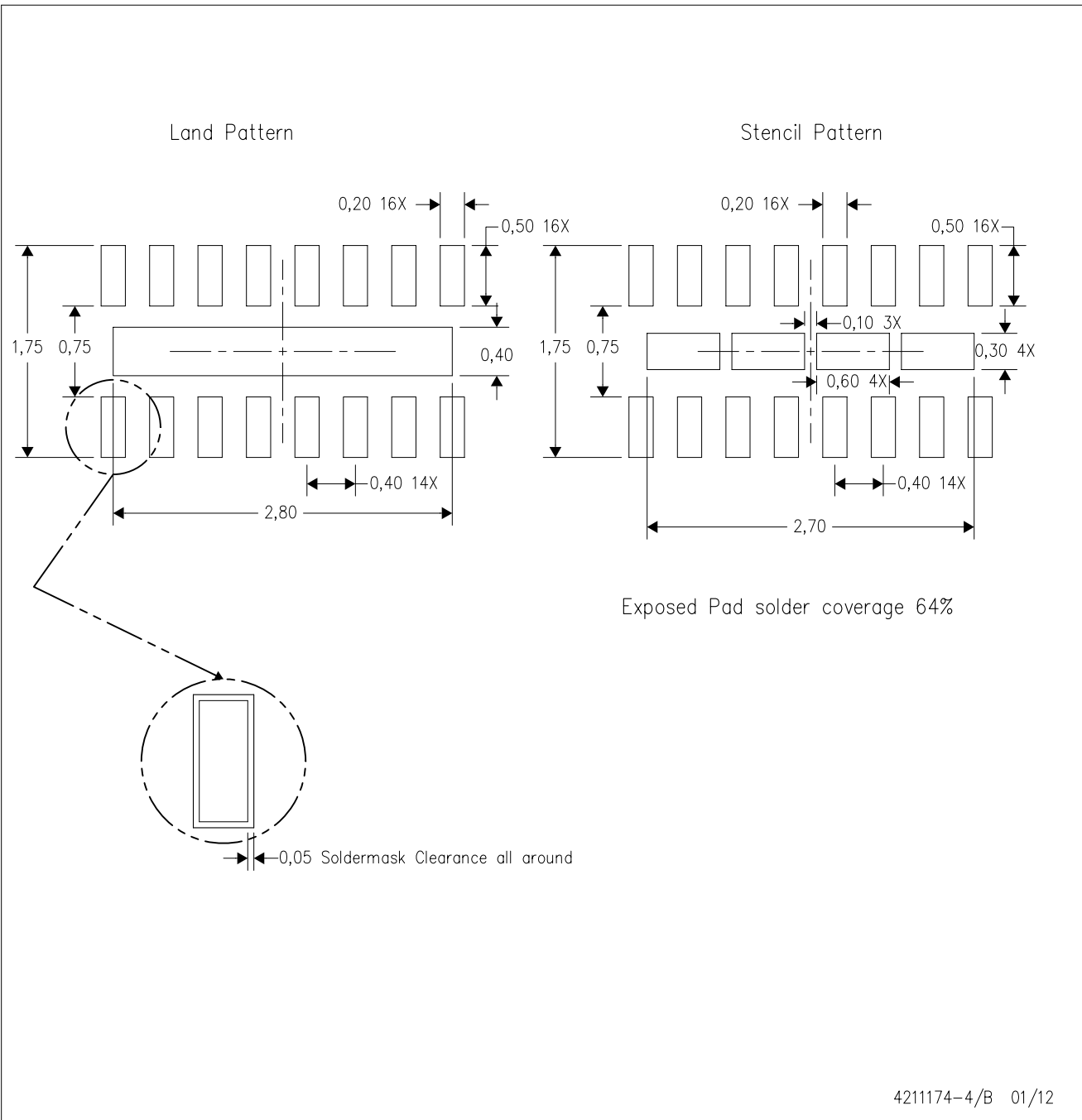

- NOTES:
- A. All linear dimensions are in millimeters.
 - B. This drawing is subject to change without notice.
 - C. Publication IPC-7351 is recommended for alternate designs.
 - D. Customers should contact their board fabrication site for minimum solder mask web tolerances between signal pads.
 - E. Maximum stencil thickness 0,1016 mm (4 mils). All linear dimensions are in millimeters.
 - F. Laser cutting apertures with trapezoidal walls and also rounding corners will offer better paste release. Customers should contact their board assembly site for stencil design recommendations. Refer to IPC 7525 for stencil design considerations.
 - G. Side aperture dimensions over-print land for acceptable area ratio > 0.66. Customer may reduce side aperture dimensions if stencil manufacturing process allows for sufficient release at smaller opening.

DSV (R-PWSON-N12)

PLASTIC SMALL OUTLINE NO-LEAD

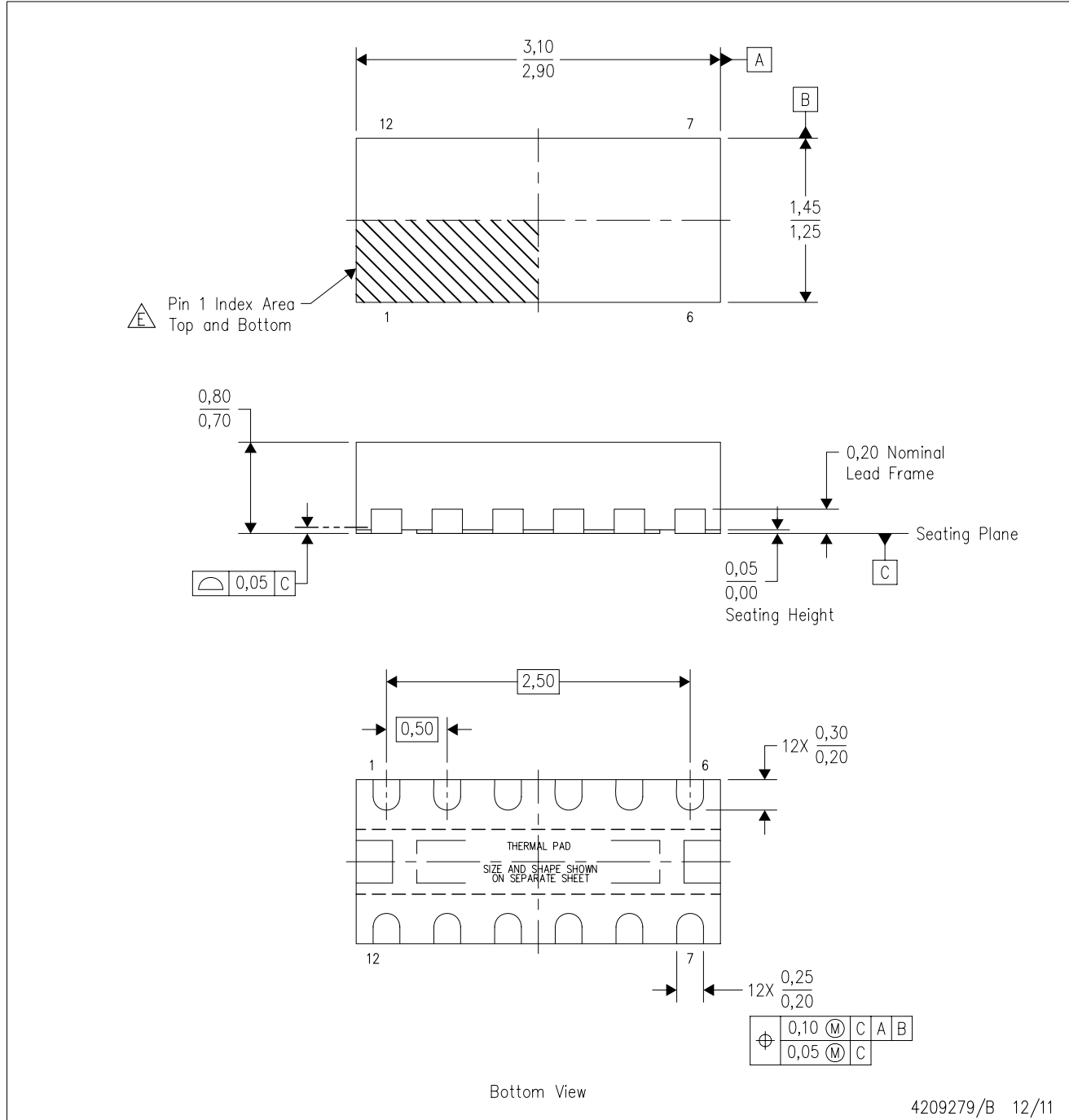

4209279/B 12/11

- NOTES:
- All linear dimensions are in millimeters. Dimensioning and tolerancing per ASME Y14.5M-1994.
 - This drawing is subject to change without notice.
 - SON (Small Outline No-Lead) package configuration.
 - The package thermal pad must be soldered to the board for thermal and mechanical performance.
 - See the additional figure in the Product Data Sheet for details regarding the exposed thermal pad features and dimensions.
- F Pin 1 identifiers are located on both top and bottom of the package and within the zone indicated. The Pin 1 identifiers are either a molded, marked, or metal feature.

DQD (R-PWSON-N8)

PLASTIC SMALL OUTLINE NO-LEAD

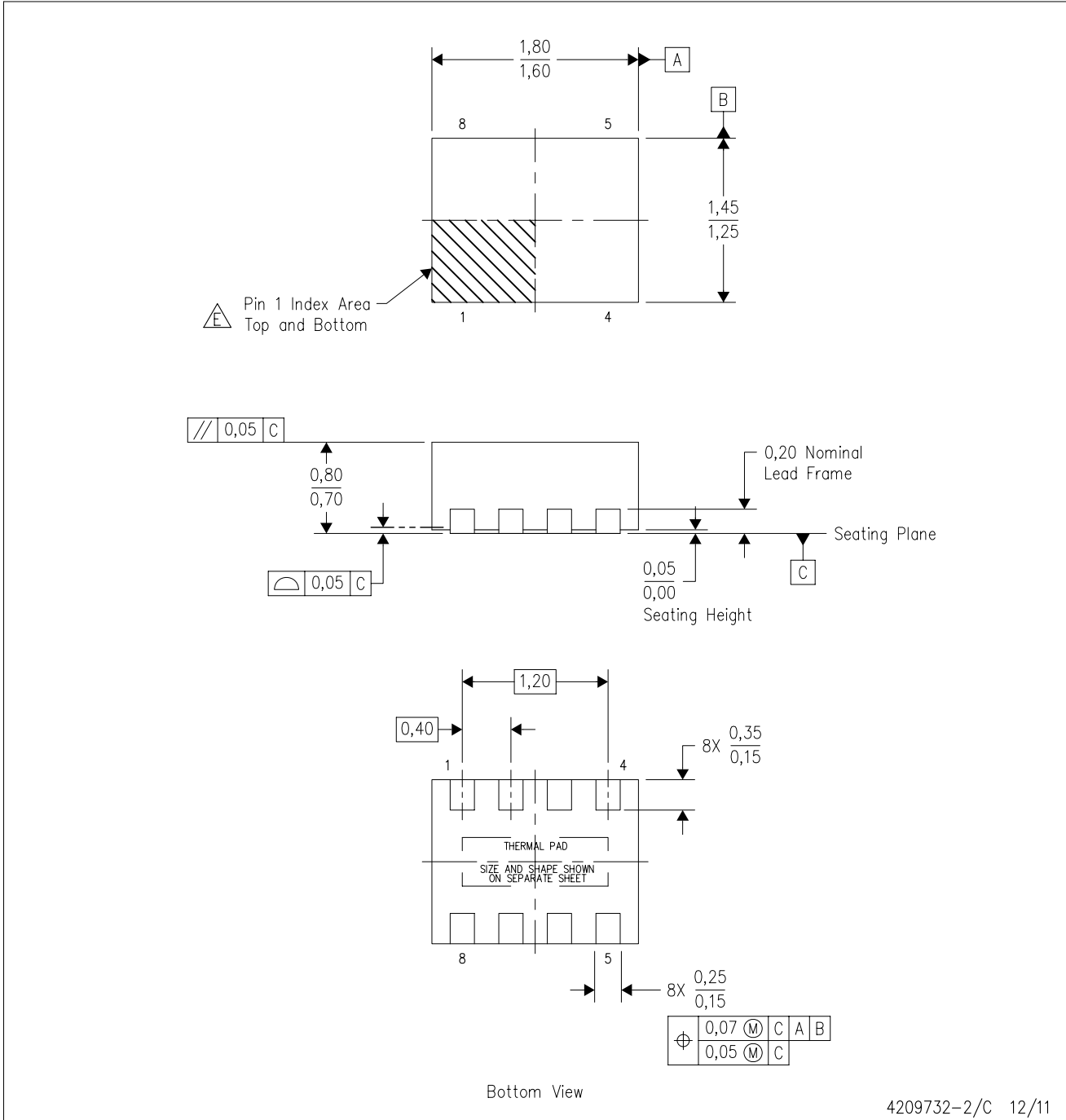

4209732-2/C 12/11

- NOTES:
- All linear dimensions are in millimeters. Dimensioning and tolerancing per ASME Y14.5M-1994.
 - This drawing is subject to change without notice.
 - SON (Small Outline No-Lead) package configuration.
 - The package thermal pad must be soldered to the board for thermal and mechanical performance.
 - See the additional figure in the Product Data Sheet for details regarding the exposed thermal pad features and dimensions.
- △ Pin 1 identifiers are located on both top and bottom of the package and within the zone indicated. The Pin 1 identifiers are either a molded, marked, or metal feature.

THERMAL PAD MECHANICAL DATA

DQD (R-PWSON-N8)

PLASTIC SMALL OUTLINE NO-LEAD

THERMAL INFORMATION

This package incorporates an exposed thermal pad that is designed to be attached directly to an external heatsink. The thermal pad must be soldered directly to the printed circuit board (PCB). After soldering, the PCB can be used as a heatsink. In addition, through the use of thermal vias, the thermal pad can be attached directly to the appropriate copper plane shown in the electrical schematic for the device, or alternatively, can be attached to a special heatsink structure designed into the PCB. This design optimizes the heat transfer from the integrated circuit (IC).

For information on the Quad Flatpack No-Lead (QFN) package and its advantages, refer to Application Report, QFN/SON PCB Attachment, Texas Instruments Literature No. SLUA271. This document is available at www.ti.com.

The exposed thermal pad dimensions for this package are shown in the following illustration.

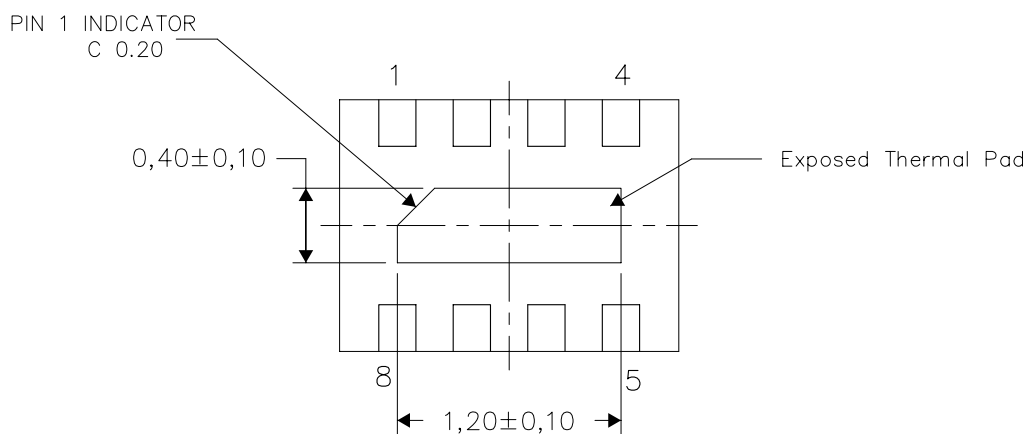

Bottom View

Exposed Thermal Pad Dimensions

4209733-2/C 12/11

NOTE: All linear dimensions are in millimeters

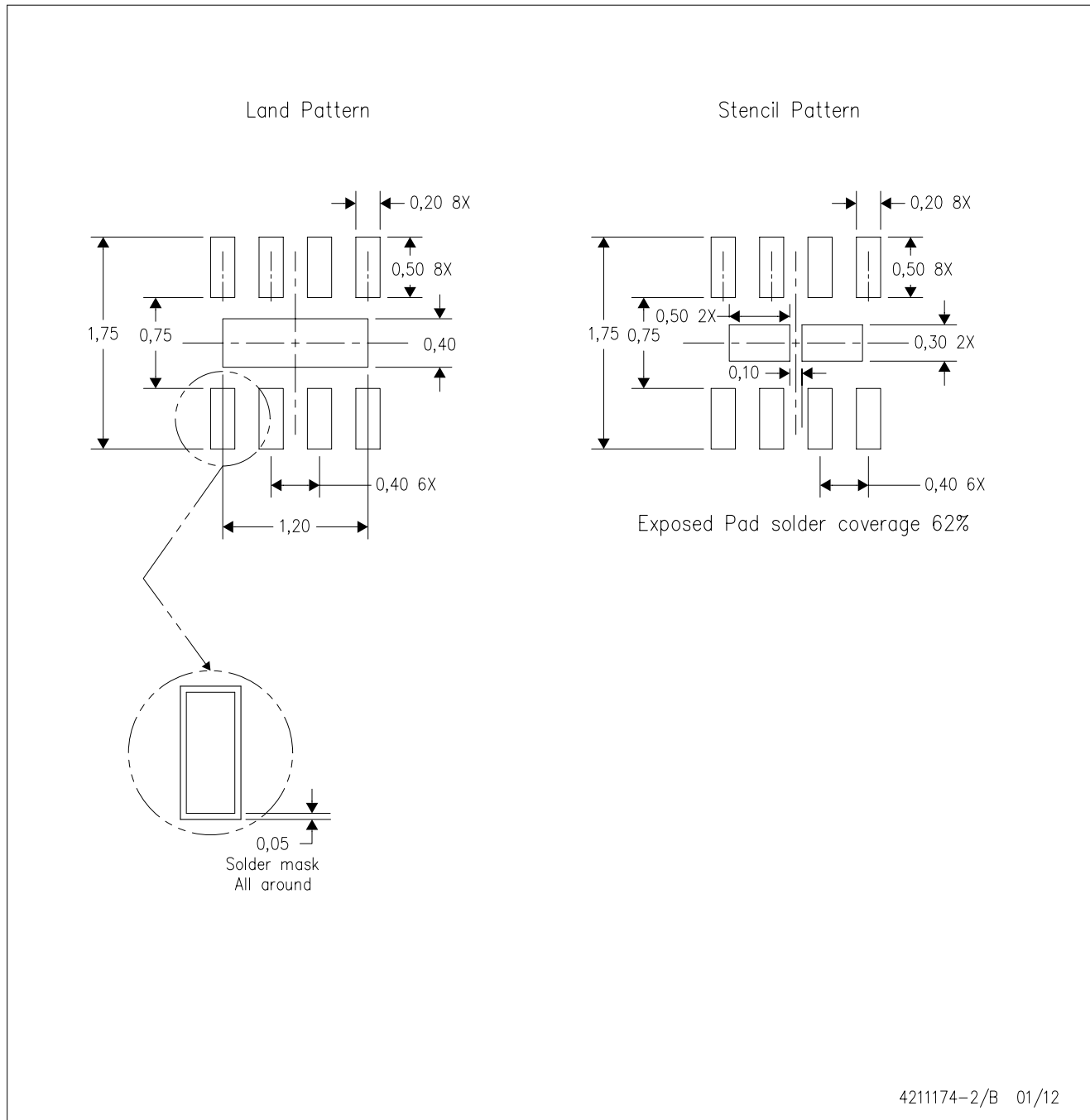

- NOTES:
- A. All linear dimensions are in millimeters.
 - B. This drawing is subject to change without notice.
 - C. Publication IPC-7351 is recommended for alternate designs.
 - D. Customers should contact their board fabrication site for minimum solder mask web tolerances between signal pads.
 - E. Maximum stencil thickness 0,1016 mm (4 mils). All linear dimensions are in millimeters.
 - F. Laser cutting apertures with trapezoidal walls and also rounding corners will offer better paste release. Customers should contact their board assembly site for stencil design recommendations. Refer to IPC 7525 for stencil design considerations.
 - G. Side aperture dimensions over-print land for acceptable area ratio > 0.66. Customer may reduce side aperture dimensions if stencil manufacturing process allows for sufficient release at smaller opening.

IMPORTANT NOTICE AND DISCLAIMER

TI PROVIDES TECHNICAL AND RELIABILITY DATA (INCLUDING DATASHEETS), DESIGN RESOURCES (INCLUDING REFERENCE DESIGNS), APPLICATION OR OTHER DESIGN ADVICE, WEB TOOLS, SAFETY INFORMATION, AND OTHER RESOURCES "AS IS" AND WITH ALL FAULTS, AND DISCLAIMS ALL WARRANTIES, EXPRESS AND IMPLIED, INCLUDING WITHOUT LIMITATION ANY IMPLIED WARRANTIES OF MERCHANTABILITY, FITNESS FOR A PARTICULAR PURPOSE OR NON-INFRINGEMENT OF THIRD PARTY INTELLECTUAL PROPERTY RIGHTS.

These resources are intended for skilled developers designing with TI products. You are solely responsible for (1) selecting the appropriate TI products for your application, (2) designing, validating and testing your application, and (3) ensuring your application meets applicable standards, and any other safety, security, or other requirements. These resources are subject to change without notice. TI grants you permission to use these resources only for development of an application that uses the TI products described in the resource. Other reproduction and display of these resources is prohibited. No license is granted to any other TI intellectual property right or to any third party intellectual property right. TI disclaims responsibility for, and you will fully indemnify TI and its representatives against, any claims, damages, costs, losses, and liabilities arising out of your use of these resources.

TI's products are provided subject to TI's Terms of Sale (<https://www.ti.com/legal/termsofsale.html>) or other applicable terms available either on [ti.com](https://www.ti.com) or provided in conjunction with such TI products. TI's provision of these resources does not expand or otherwise alter TI's applicable warranties or warranty disclaimers for TI products.

Mailing Address: Texas Instruments, Post Office Box 655303, Dallas, Texas 75265
Copyright © 2021, Texas Instruments Incorporated