

# NAIS

## HIGH PERFORMANCE MINIATURE SWITCHES WITH WIDE RANGE

# NV (AH7) SWITCHES



### FEATURES

- Extra long-life spring mechanism  
—More than  $10^7$  mechanical operations,  
 $10^5$  electrical
- High contact rating of 15 Amps with  
an operating force of only 200 g 7.05 oz
- Safety insulation guard types avail-  
able
- Available in a wide operating force  
and capacity range
- UL/CSA/VDE/SEMKO approved

### TYPICAL APPLICATIONS

- Home appliances
- Vending machines
- Amusement and communication  
equipment
- Copiers
- General industrial machines

## ORDERING INFORMATION

Ex. AH7

Type of switch	Contact arrangement	Terminal	Actuators	Operating force by pin plunger (max.)								
				Type	0.15N {15gf}	0.25N {25gf}	0.49N {50gf}	0.98N {100gf}	1.96N {200gf}	3.92N {400gf}		
NV switch	1: Bottom COM terminal SPDT 2: Bottom COM terminal SPST-NC 3: Bottom COM terminal SPST-NO 4: Side COM terminal SPDT 5: Side COM terminal SPST-NC 6: Side COM terminal SPST-NO	*(1: Solder terminal with right-hand guard) *(2: Solder terminal without guard) 4: .187 Quick-connect/solder terminal with right-hand guard 5: .187 Quick-connect/solder terminal without guard *(8: .250 Quick-connect terminal)	0: Pin plunger 1: Short hinge lever 2: Hinge lever 3: Long hinge lever 4: Simulated roller lever 5: Short roller lever 6: Roller lever 8: Wire lever	Standard type	—	—	360	460	5	7		
				Heat resistant type	.187 Quick-connect/solder terminal without guard		—	—	356	456	555	755
				(Standard)	Solder terminal without guard .250 Quick-connect terminal		—	—	*(355)	*(455)		
				Low-level circuit type (Standard)	—	—	361	461	561	—		
				Heat resistant type (Low-level circuit type)	162	262	362	462	562	—		

Remark: Please consult us for \* marked product.

## TERMINALS

mm inch

### 1. .187 Quick-connect/solder terminal

1) Bottom COM terminal

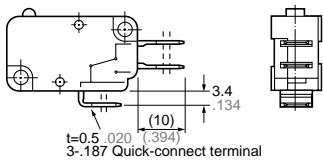

2) Side COM terminal

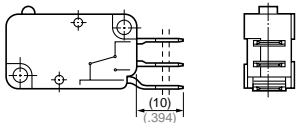

3) Terminal portion dimensions

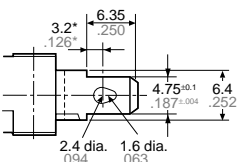

\* Indicating for the center of 1.6 dia. .063 dia.

### 2. Solder terminal

1) Bottom COM terminal

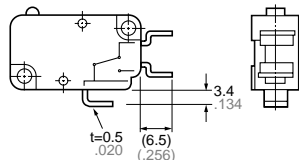

2) Terminal portion dimensions

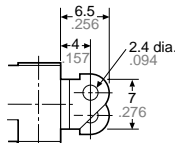

### 3. .250 Quick-connect terminal

1) Bottom COM terminal

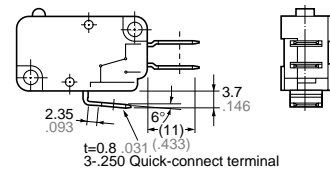

2) Terminal portion dimensions

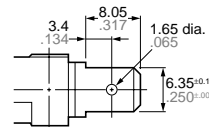

## PRODUCT TYPES

### 1. Standard type

Bottom COM terminal .187 Quick-connect/solder terminal without guard

Actuators	Operating force, max.	Contact arrangement		
		SPDT	SPST-NC	SPST-NO
Pin plunger	0.49N{50gf}	AH7150360	AH7250360	AH7350360
	0.98N{100gf}	AH7150460	AH7250460	AH7350460
	1.96N{200gf}	AH71505	AH72505	AH73505
	3.92N{400gf}	AH71507	AH72507	AH73507
Short hinge lever	0.49N{50gf}	AH7151360	AH7251360	AH7351360
	0.98N{100gf}	AH7151460	AH7251460	AH7351460
	1.96N{200gf}	AH71515	AH72515	AH73515
	3.92N{400gf}	AH71517	AH72517	AH73517
Hinge lever	0.49N{50gf}	AH7152360	AH7252360	AH7352360
	0.98N{100gf}	AH7152460	AH7252460	AH7352460
	1.96N{200gf}	AH71525	AH72525	AH73525
	3.92N{400gf}	AH71527	AH72527	AH73527
Long hinge lever	0.49N{50gf}	AH7153360	AH7253360	AH7353360
	0.98N{100gf}	AH7153460	AH7253460	AH7353460
	1.96N{200gf}	AH71535	AH72535	AH73535
	3.92N{400gf}	AH71537	AH72537	AH73537
Simulated roller lever	0.49N{50gf}	AH7154360	AH7254360	AH7354360
	0.98N{100gf}	AH7154460	AH7254460	AH7354460
	1.96N{200gf}	AH71545	AH72545	AH73545
	3.92N{400gf}	AH71547	AH72547	AH73547
Short roller lever	0.49N{50gf}	AH7155360	AH7255360	AH7355360
	0.98N{100gf}	AH7155460	AH7255460	AH7355460
	1.96N{200gf}	AH71555	AH72555	AH73555
	3.92N{400gf}	AH71557	AH72557	AH73557
Roller lever	0.49N{50gf}	AH7156360	AH7256360	AH7356360
	0.98N{100gf}	AH7156460	AH7256460	AH7356460
	1.96N{200gf}	AH71565	AH72565	AH73565
	3.92N{400gf}	AH71567	AH72567	AH73567

Remarks: 1. When ordering solder terminal, change the fifth digit of part number from "5" to "2" and delete suffix "60" from the part no.  
 2. When ordering 2.94N{300gf} types, insert the number "6" at the seventh digit of part no. instead of "360", "460", "5" or "7".  
 3. When ordering international standard approved types, please attach the following number to the part no.  
 9: UL/CSA 6×10<sup>3</sup> rated  
 4: UL/CSA 10<sup>5</sup> rated  
 8: VDE/SEMKO  
 7: UL TV rating

# AH7

Side COM terminal .187 Quick-connect/solder terminal with right-hand guard

Actuators	Operating force, max.	Contact arrangement		
		SPDT	SPST-NC	SPST-NO
Pin plunger	0.49N{50gf}	AH7440360	AH7540360	AH7640360
	0.98N{100gf}	AH7440460	AH7540460	AH7640460
	1.96N{200gf}	AH74405	AH75405	AH76405
	3.92N{400gf}	AH74407	AH75407	AH76407
Short hinge lever	0.49N{50gf}	AH7441360	AH7541360	AH7641360
	0.98N{100gf}	AH7441460	AH7541460	AH7641460
	1.96N{200gf}	AH74415	AH75415	AH76415
	3.92N{400gf}	AH74417	AH75417	AH76417
Hinge lever	0.49N{50gf}	AH7442360	AH7542360	AH7642360
	0.98N{100gf}	AH7442460	AH7542460	AH7642460
	1.96N{200gf}	AH74425	AH75425	AH76425
	3.92N{400gf}	AH74427	AH75427	AH76427
Long hinge lever	0.49N{50gf}	AH7443360	AH7543360	AH7643360
	0.98N{100gf}	AH7443460	AH7543460	AH7643460
	1.96N{200gf}	AH74435	AH75435	AH76435
	3.92N{400gf}	AH74437	AH75437	AH76437
Simulated roller lever	0.49N{50gf}	AH7444360	AH7544360	AH7644360
	0.98N{100gf}	AH7444460	AH7544460	AH7644460
	1.96N{200gf}	AH74445	AH75445	AH76445
	3.92N{400gf}	AH74447	AH75447	AH76447
Short roller lever	0.49N{50gf}	AH7445360	AH7545360	AH7645360
	0.98N{100gf}	AH7445460	AH7545460	AH7645460
	1.96N{200gf}	AH74455	AH75455	AH76455
	3.92N{400gf}	AH74457	AH75457	AH76457
Roller lever	0.49N{50gf}	AH7446360	AH7546360	AH7646360
	0.98N{100gf}	AH7446460	AH7546460	AH7646460
	1.96N{200gf}	AH74465	AH75465	AH76465
	3.92N{400gf}	AH74467	AH75467	AH76467

Remarks: 1. When ordering 2.94N{300gf} types, insert the number "6" at the seventh digit of part no.

2. When ordering international standard approved types, please attach the following number to the part no.

9: UL/CSA 6×10<sup>3</sup> rated

4: UL/CSA 10<sup>5</sup> rated

8: VDE/SEMKO (Not every part no. are approved. Please consult us.)

7: UL TV rating

## Side COM terminal .187 Quick-connect/solder terminal without guard

Actuators	Operating force, max.	Contact arrangement		
		SPDT	SPST-NC	SPST-NO
Pin plunger	0.49N{50gf}	AH7450360	AH7550360	AH7650360
	0.98N{100gf}	AH7450460	AH7550460	AH7650460
	1.96N{200gf}	AH74505	AH75505	AH76505
	3.92N{400gf}	AH74507	AH75507	AH76507
Short hinge lever	0.49N{50gf}	AH7451360	AH7551360	AH7651360
	0.98N{100gf}	AH7451460	AH7551460	AH7651460
	1.96N{200gf}	AH74515	AH75515	AH76515
	3.92N{400gf}	AH74517	AH75517	AH76517
Hinge lever	0.49N{50gf}	AH7452360	AH7552360	AH7652360
	0.98N{100gf}	AH7452460	AH7552460	AH7652460
	1.96N{200gf}	AH74525	AH75525	AH76525
	3.92N{400gf}	AH74527	AH75527	AH76527
Long hinge lever	0.49N{50gf}	AH7453360	AH7553360	AH7653360
	0.98N{100gf}	AH7453460	AH7553460	AH7653460
	1.96N{200gf}	AH74535	AH75535	AH76535
	3.92N{400gf}	AH74537	AH75537	AH76537
Simulated roller lever	0.49N{50gf}	AH7454360	AH7554360	AH7654360
	0.98N{100gf}	AH7454460	AH7554460	AH7654460
	1.96N{200gf}	AH74545	AH75545	AH76545
	3.92N{400gf}	AH74547	AH75547	AH76547
Short roller lever	0.49N{50gf}	AH7455360	AH7555360	AH7655360
	0.98N{100gf}	AH7455460	AH7555460	AH7655460
	1.96N{200gf}	AH74555	AH75555	AH76555
	3.92N{400gf}	AH74557	AH75557	AH76557
Roller lever	0.49N{50gf}	AH7456360	AH7556360	AH7656360
	0.98N{100gf}	AH7456460	AH7556460	AH7656460
	1.96N{200gf}	AH74565	AH75565	AH76565
	3.92N{400gf}	AH74567	AH75567	AH76567

Remarks: 1. When ordering 2.94N{300gf} types, insert the number "6" at the seventh digit of part no.  
2. When ordering international standard approved types, please attach the following number to the part no.  
9: UL/CSA 6×10<sup>3</sup> rated  
4: UL/CSA 10<sup>5</sup> rated  
8: VDE/SEMKO (Not every part no. are approved. Please consult us.)  
7: UL TV rating

# AH7

## 2. Heat resistant type (Standard)

.187 Quick-connect/solder terminal without guard

Actuators	Operating force, max.	Bottom COM terminal	Side COM terminal
Pin plunger	0.49N{50gf}	AH7150356	AH7450356
	0.98N{100gf}	AH7150456	AH7450456
	1.96N{200gf}	AH7150555	AH7450555
	3.92N{400gf}	AH7150755	AH7450755
Short hinge lever	0.59N{60gf}	AH7151356	AH7451356
	1.08N{110gf}	AH7151456	AH7451456
	2.16N{220gf}	AH7151555	AH7451555
	4.12N{420gf}	AH7151755	AH7451755
Hinge lever	0.29N{30gf}	AH7152356	AH7452356
	0.59N{60gf}	AH7152456	AH7452456
	1.18N{120gf}	AH7152555	AH7452555
	2.35N{240gf}	AH7152755	AH7452755
Long hinge lever	0.15N{15gf}	AH7153356	AH7453356
	0.29N{30gf}	AH7153456	AH7453456
	0.59N{60gf}	AH7153555	AH7453555
	1.18N{120gf}	AH7153755	AH7453755
Simulated roller lever	0.29N{30gf}	AH7154356	AH7454356
	0.59N{60gf}	AH7154456	AH7454456
	1.18N{120gf}	AH7154555	AH7454555
	2.35N{240gf}	AH7154755	AH7454755
Short roller lever	0.59N{60gf}	AH7155356	AH7455356
	1.08N{110gf}	AH7155456	AH7455456
	2.16N{220gf}	AH7155555	AH7455555
	4.12N{420gf}	AH7155755	AH7455755
Roller lever	0.29N{30gf}	AH7156356	AH7456356
	0.59N{60gf}	AH7156456	AH7456456
	1.18N{120gf}	AH7156555	AH7456555
	2.35N{240gf}	AH7156755	AH7456755

Remarks: 1. When ordering solder terminal, change the fifth digit of part number from "5" to "2".

(ex.) AH7150555→AH7120555

2. When ordering 2.94N{300gf} types, insert the number "655" at the seventh digit of part no. instead of "356", "456", "555" or "755".

3. Please consult us for NC and NO types.

4. When ordering international standard approved types, please attach the following number to the part no.

9: UL/CSA 6×10<sup>3</sup> rated

8: VDE/SEMKO

7: UL TV rating

## 3. Heat resistant type (Low-level circuit type)

Actuators	Operating force, max.	Bottom COM terminal	Side COM terminal
Pin plunger	0.15N{15gf}	AH7150162	AH7450162
	0.25N{25gf}	AH7150262	AH7450262
	0.49N{50gf}	AH7150362	AH7450362
	0.98N{100gf}	AH7150462	AH7450462
	1.96N{200gf}	AH7150562	AH7450562
Short hinge lever	0.59N{60gf}	AH7151362	AH7451362
	1.08N{110gf}	AH7151462	AH7451462
	2.16N{220gf}	AH7151562	AH7451562
Hinge lever	0.29N{30gf}	AH7152362	AH7452362
	0.59N{60gf}	AH7152462	AH7452462
	1.18N{120gf}	AH7152562	AH7452562
Long hinge lever	0.15N{15gf}	AH7153362	AH7453362
	0.29N{30gf}	AH7153462	AH7453462
	0.59N{60gf}	AH7153562	AH7453562
Simulated roller lever	0.29N{30gf}	AH7154362	AH7454362
	0.59N{60gf}	AH7154462	AH7454462
	1.18N{120gf}	AH7154562	AH7454562
Short roller lever	0.59N{60gf}	AH7155362	AH7455362
	1.08N{110gf}	AH7155462	AH7455462
	2.16N{220gf}	AH7155562	AH7455562
Roller lever	0.29N{30gf}	AH7156362	AH7456362
	0.59N{60gf}	AH7156462	AH7456462
	1.18N{120gf}	AH7156562	AH7456562
Wire lever	0.098N{10gf}	AH7158162	AH7458162
	0.15N{15gf}	AH7158262	AH7458262

Remarks: 1. Please consult us for NC and NO types.

2. As for International standard, please refer to the "Information".

## SPECIFICATIONS

### 1. Contact rating

Contact	Operating force by pin plunger (max.)	Rating (resistive load)
Silver alloy	0.49N {50gf}	5A 250V AC, 0.5A 125V DC
	0.98N {100gf}	10A 250V AC, 0.6A 125V DC
	1.96N, 2.94N, 3.92N {200gf, 300gf, 400gf}	15A 250V AC, 0.6A 125V DC
Gold clad	0.15N {15gf}	1A 250V AC
	0.25 to 1.96N {25 to 200gf}	3A 250V AC

- Gold clad low level circuit type (resistive load)  
6V DC 5mA  
12V DC 2mA  
24V DC 1mA

### 2. Characteristics

Contact		Silver alloy			Gold clad				
Operating force by pin plunger (max.)		0.49N {50gf}	0.98N {100gf}	1.96N, 2.94N, 3.92N {200, 300, 400gf}	0.15N {15gf}	0.25N {25gf}	0.49N {50gf}	0.98N {100gf}	1.96N {200gf}
Expected life (min.)	Mechanical (at O.T. rated)	Min. 10 <sup>7</sup> (at 60 cpm)							
	Electrical (at O.T. min.)	Min. 10 <sup>5</sup> (at rated load, 20 cpm)							
Insulation resistance (min.)		Min. 100MΩ (at 500V DC)							
Dielectric strength	Between terminals	1,000V AC for 1min.							
	Between terminals and other exposed metal parts	1,500V AC for 1min.							
	Between terminals and ground	1,500V AC for 1min.							
Contact resistance (Initial)		Max. 50mΩ (by voltage drop at 1A 6 to 8V DC)			Max. 50 mΩ (by voltage drop at 1A 6 to 8V DC)				
Vibration resistance (by pin plunger types)		10 to 55 Hz at amplitude of 0.75mm (Contact opening: max. 1msec.)							
Shock resistance (by pin plunger types) Min.		98m/s <sup>2</sup> {10G}	196m/s <sup>2</sup> {20G}	294m/s <sup>2</sup> {30G}	98m/s <sup>2</sup> {10G}		196m/s <sup>2</sup> {20G}	294m/s <sup>2</sup> {30G}	
Allowable operating speed		0.1 to 1,000mm/sec.							
Max. operating cycle rate		600/min.			300/min.		600/min.		
Ambient temperature		-25°C to +80°C -13°F to +176°F (No freezing below 0°C)							
Ambient humidity		Max. 85% R.H.							
Unit weight		8g .28oz							

### 3. Operating characteristics

#### 1) Pin plunger

mm inch

Seventh digit of part number	O.F. max.	R.F. min.	P.T. max.	M.D. max.	O.T. min.	O.P. max.
1	0.15N{15gf}	0.029N{3gf}	1.6 .063	0.8 .031	0.8 .031	14.7±0.6 .579±.024
2	0.25N{25gf}	0.059N{6gf}	1.6 .063	0.8 .031	0.8 .031	14.7±0.6 .579±.024
3	0.49N{50gf}	0.12N{12gf}	1.6 .063	0.4 .016	0.8 .031	14.7±0.6 .579±.024
4	0.98N{100gf}	0.25N{25gf}	1.6 .063	0.4 .016	0.8 .031	14.7±0.6 .579±.024
5	1.96N{200gf}	0.49N{50gf}	1.6 .063	0.4 .016	0.8 .031	14.7±0.6 .579±.024
6	2.94N{300gf}	0.74N{75gf}	1.6 .063	0.4 .016	0.8 .031	14.7±0.6 .579±.024
7	3.92N{400gf}	0.98N{100gf}	1.6 .063	0.4 .016	0.8 .031	14.7±0.6 .579±.024

#### 2) Short hinge lever

Seventh digit of part number	O.F. max.	R.F. min.	P.T. max.	M.D. max.	O.T. min.	O.P. max.
3	0.59N{60gf}	0.098N{10gf}	1.6 .063	0.5 .020	0.8 .031	15.3±0.8 .602±.031
4	1.08N{110gf}	0.20N{20gf}	1.6 .063	0.5 .020	0.8 .031	15.3±0.8 .602±.031
5	2.16N{220gf}	0.39N{40gf}	1.6 .063	0.5 .020	0.8 .031	15.3±0.8 .602±.031
6	3.14N{320gf}	0.59N{60gf}	1.6 .063	0.5 .020	0.8 .031	15.3±0.8 .602±.031
7	4.12N{420gf}	0.78N{80gf}	1.6 .063	0.5 .020	0.8 .031	15.3±0.8 .602±.031

#### 3) Hinge lever

Seventh digit of part number	O.F. max.	R.F. min.	P.T. max.	M.D. max.	O.T. min.	O.P. max.
3	0.29N{30gf}	0.049N{5gf}	3.2 .126	1.2 .047	1.2 .047	15.3±1.2 .602±.047
4	0.59N{60gf}	0.098N{10gf}	3.2 .126	1.2 .047	1.2 .047	15.3±1.2 .602±.047
5	1.18N{120gf}	0.20N{20gf}	3.2 .126	1.2 .047	1.2 .047	15.3±1.2 .602±.047
6	1.77N{180gf}	0.29N{30gf}	3.2 .126	1.2 .047	1.2 .047	15.3±1.2 .602±.047
7	2.35N{240gf}	0.39N{40gf}	3.2 .126	1.2 .047	1.2 .047	15.3±1.2 .602±.047

# AH7

## 4) Long hinge lever

Seventh digit of part number	O.F. max.	R.F. min.	P.T. max.	M.D. max.	O.T. min.	O.P. max.
3	0.15N{15gf}	0.025N{2.5gf}	7.5 .295	2.2 .087	2.2 .087	15.3±2.6 .602±.102
4	0.29N{30gf}	0.049N{5gf}	7.5 .295	2.2 .087	2.2 .087	15.3±2.6 .602±.102
5	0.59N{60gf}	0.098N{10gf}	7.5 .295	2.2 .087	2.2 .087	15.3±2.6 .602±.102
6	0.88N{90gf}	0.15N{15gf}	7.5 .295	2.2 .087	2.2 .087	15.3±2.6 .602±.102
7	1.18N{120gf}	0.39N{40gf}	7.5 .295	2.2 .087	2.2 .087	15.3±2.6 .602±.102

## 5) Simulated roller lever

Seventh digit of part number	O.F. max.	R.F. min.	P.T. max.	M.D. max.	O.T. min.	O.P. max.
3	0.29N{30gf}	0.049N{5gf}	3.2 .126	1.2 .047	1.2 .047	18.5±1.2 .728±.047
4	0.59N{60gf}	0.098N{10gf}	3.2 .126	1.2 .047	1.2 .047	18.5±1.2 .728±.047
5	1.18N{120gf}	0.20N{20gf}	3.2 .126	1.2 .047	1.2 .047	18.5±1.2 .728±.047
6	1.77N{180gf}	0.29N{30gf}	3.2 .126	1.2 .047	1.2 .047	18.5±1.2 .728±.047
7	2.35N{240gf}	0.39N{40gf}	3.2 .126	1.2 .047	1.2 .047	18.5±1.2 .728±.047

## 6) Short roller lever

Seventh digit of part number	O.F. max.	R.F. min.	P.T. max.	M.D. max.	O.T. min.	O.P. max.
3	0.59N{60gf}	0.098N{10gf}	1.6 .063	0.5 .020	0.8 .031	20.7±0.8 .815±.031
4	1.08N{110gf}	0.20N{20gf}	1.6 .063	0.5 .020	0.8 .031	20.7±0.8 .815±.031
5	2.16N{220gf}	0.39N{40gf}	1.6 .063	0.5 .020	0.8 .031	20.7±0.8 .815±.031
6	3.14N{320gf}	0.59N{60gf}	1.6 .063	0.5 .020	0.8 .031	20.7±0.8 .815±.031
7	4.12N{420gf}	0.78N{80gf}	1.6 .063	0.5 .020	0.8 .031	20.7±0.8 .815±.031

## 7) Roller lever

Seventh digit of part number	O.F. max.	R.F. min.	P.T. max.	M.D. max.	O.T. min.	O.P. max.
3	0.29N{30gf}	0.049N{5gf}	3.2 .126	1.2 .047	1.2 .047	20.7±1.2 .815±.047
4	0.59N{60gf}	0.098N{10gf}	3.2 .126	1.2 .047	1.2 .047	20.7±1.2 .815±.047
5	1.18N{120gf}	0.20N{20gf}	3.2 .126	1.2 .047	1.2 .047	20.7±1.2 .815±.047
6	1.77N{180gf}	0.29N{30gf}	3.2 .126	1.2 .047	1.2 .047	20.7±1.2 .815±.047
7	2.35N{240gf}	0.39N{40gf}	3.2 .126	1.2 .047	1.2 .047	20.7±1.2 .815±.047

## 8) Wire lever

Seventh digit of part number	O.F. max.	R.F. min.	P.T. max.	M.D. max.	O.T. min.	O.P. max.
1	0.098N{10gf}	0.010N{1gf}	3.5 .138	2 .079	1.2 .047	15.5±1.4 .610±.055
2	0.15N{15gf}	0.020N{2gf}	3.5 .138	2 .079	1.2 .047	15.5±1.4 .610±.055

## DIMENSIONS

mm inch

### 1. Pin plunger

Bottom COM terminal (Guardless)



.187 Quick-connect/Solder terminal

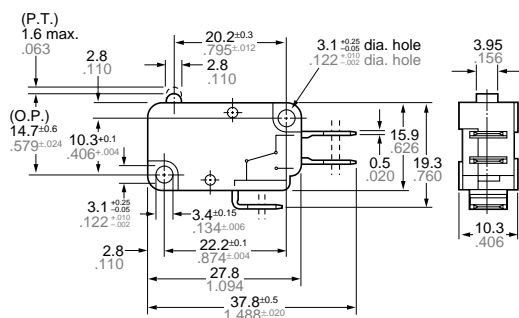

Solder terminal

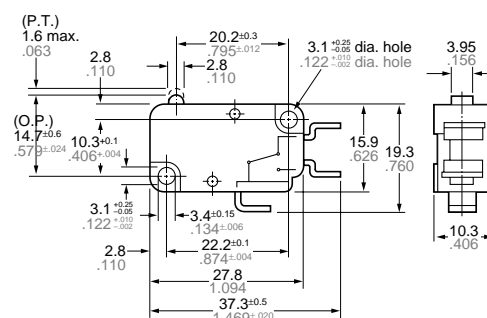

Side COM terminal (with right-hand guard)



.187 Quick-connect/Solder terminal

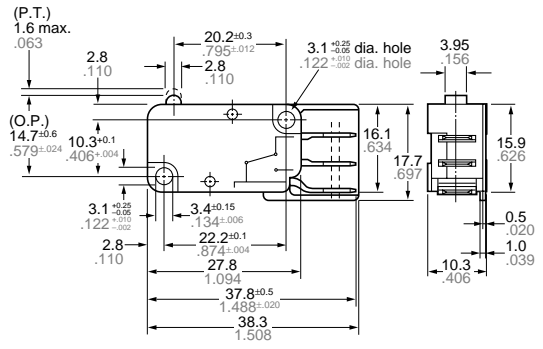

Side COM terminal (Guardless)



.187 Quick-connect/Solder terminal

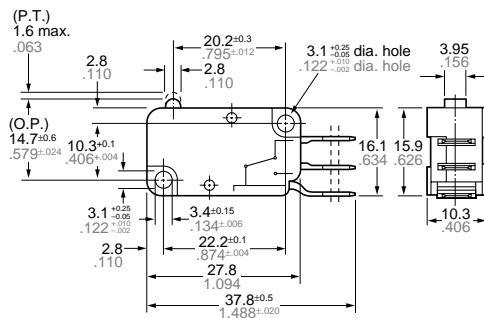

2. Short hinge lever

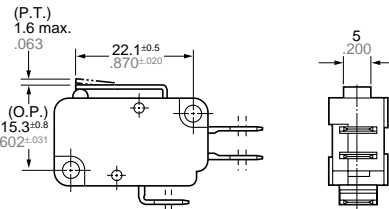

3. Hinge lever

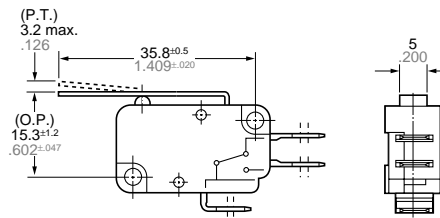

4. Long hinge lever

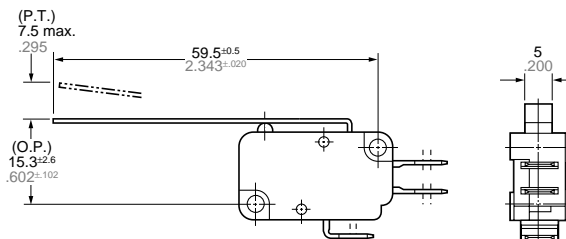



## 5. Simulated roller lever

mm inch

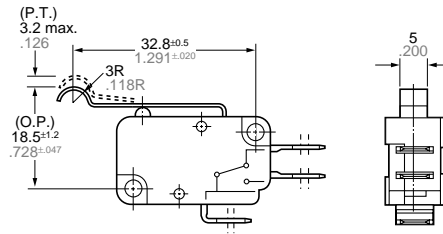

## 6. Short roller lever

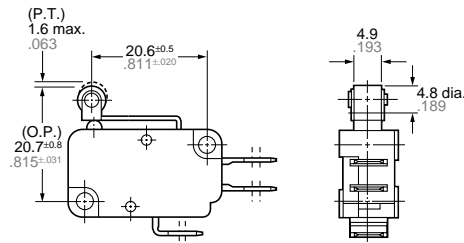

## 7. Roller lever

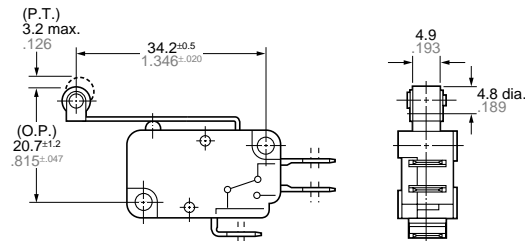

## 8. Wire lever

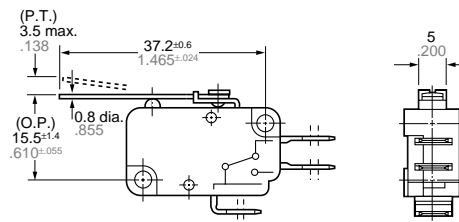

## NOTES

1. Use 3.0mm mounting screws to mount switches with less than a 5 kg-cm torque. Use of screw washers or adhesive lock is recommended. Before mounting, check insulation distance between terminals as well as between terminals and ground. If enough distance is not secured, it is recommended to use insulation material in mounting.  
 Set 70 to 100% overtravel in actual use. When the operation object is in the free position, force should not be applied directly to the actuator or to the pin plunger. Also force should be applied to the pin plunger from vertical direction to the switch.

2. When specifying NV switches, allow  $\pm$ 20% to the listed operating and release forces.  
 3. Hand soldering should be accomplished in less than 5 seconds, preferably with a 60 watt iron. Avoid contacting the switch case with the soldering iron.  
 4. Low-level circuit type is recommended for using under low-level current and voltage.

5. Avoid using NV switches in the following conditions:

- In corrosive gases, such as hydrogen sulfide.
- In flammable or explosive gases such as gasoline or thinner etc.
- In a dusty environment.
- In an ambient temperature under  $-25^{\circ}\text{C}$   $-13^{\circ}\text{F}$  or over  $80^{\circ}\text{C}$   $176^{\circ}\text{F}$ .
- In an ambient humidity over 85% R.H..