

Surface Mounting Chip LED

SS Type

Global Part No.	Conventional Part No.	Lighting Color
LNJ208R8ARA	LNJ208R8ARA	Red
LNJ208R8RRA	LNJ208R8RRA	Red
LNJ308G8LRA	LNJ308G8LRA	Green
LNJ308G8TRA	LNJ308G8TRA	Green
LNJ408K8YRA	LNJ408K8YRA	Amber
LNJ408K8ZRA	LNJ408K8ZRA	Amber
LNJ808R8ERA	LNJ808R8ERA	Orange
LNJ808K8SRA	LNJ808K8SRA	Soft Orange

Absolute Maximum Ratings ($T_a=25^\circ\text{C}$)

Lighting Color	P(mW)	I_{FDC} (mA)	I_{FP} (mA)*	V_{R} (V)	T_{opr} ($^\circ\text{C}$)	T_{stg} ($^\circ\text{C}$)
Red	50	20	100	3	-30~+85	-40~+100
Red	50	20	100	4	-25~+85	-40~+100
Green	30	10	50	4	-30~+85	-40~+100
Green	50	20	100	4	-30~+85	-40~+100
Amber	50	20	100	4	-30~+85	-40~+100
Amber	30	10	50	4	-30~+85	-40~+100
Orange	30	10	50	3	-30~+85	-40~+100
Soft Orange	50	20	100	3	-30~+85	-40~+100

*The condition of I_{pp} is 10%, Pulse width 1 msec.

Electro-Optical Characteristics ($T_a=25^\circ\text{C}$)

Global Part No.	Lighting Color	Lens Color	I_{O}		I_{F}	V_{F}		λ_{p}	$\Delta\lambda$	I_{F}	I_{R}	
			Typ	Min		Typ	Max				Max	V_{R}
LNJ208R8ARA	Red	Red Diffused	6.7	2.2	10	1.72	2.5	660	20	10	100	3
LNJ208R8RRA	Red	Red Diffused	0.45	0.2	10	2.03	2.6	700	100	10	10	4
LNJ308G8LRA	Green	Green Diffused	3.0	1.5	5	1.9	2.4	565	30	5	10	4
LNJ308G8TRA	Green	Green Diffused	5.0	1.8	10	2.03	2.6	565	30	10	10	4
LNJ408K8YRA	Amber	Amber Diffused	1.5	0.6	10	2.0	2.6	590	30	10	10	4
LNJ408K8ZRA	Amber	Amber Diffused	0.9	0.4	5	1.9	2.4	590	30	5	10	4
LNJ808R8ERA	Orange	Orange Diffused	1.1	0.4	5	1.8	2.4	630	40	5	10	3
LNJ808K8SRA	Soft Orange	Yellow Diffused	1.0	0.4	10	1.93	2.6	610	40	10	10	3
Unit	—	—	mcd	mcd	mA	V	V	nm	nm	mA	μA	V

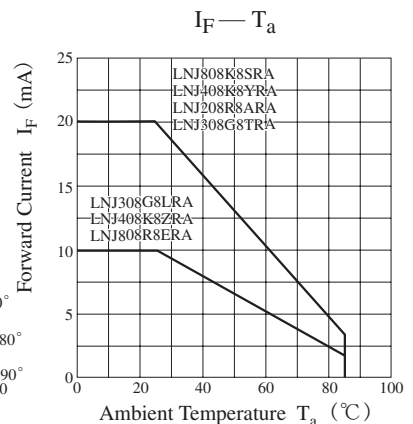
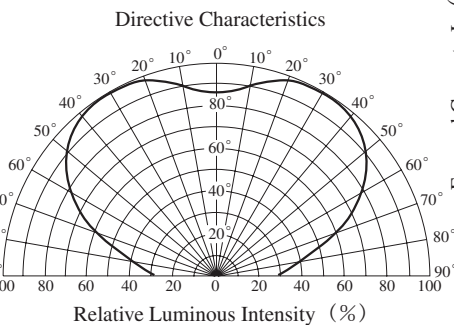
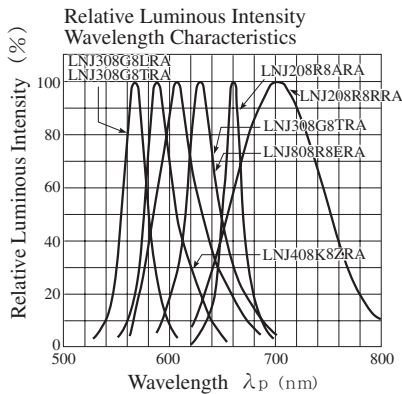
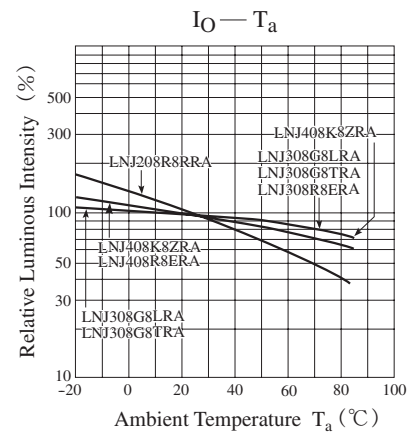
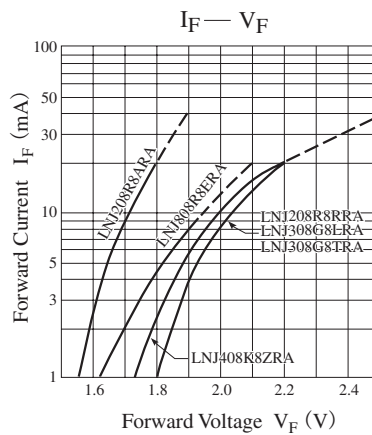
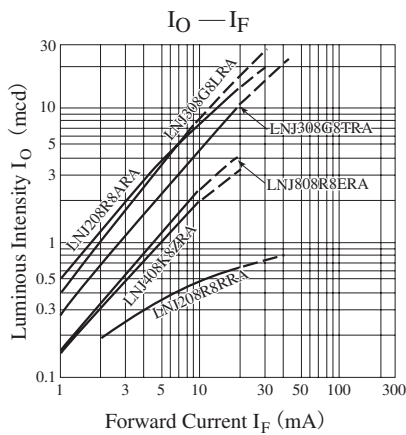
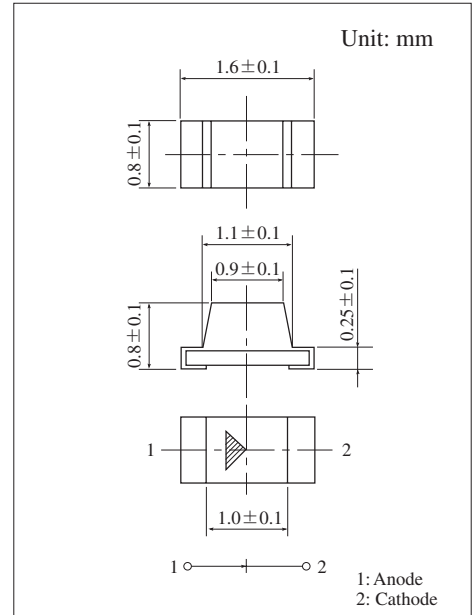

Caution for Safety

 **DANGER**

■ This product contains Gallium Arsenide (GaAs).

GaAs powder and vapor are hazardous to human health if inhaled or ingested. Do not burn, destroy, cut, cleave off, or chemically dissolve the product. Follow related laws and ordinances for disposal. The product should be excluded from general industrial waste or household garbage.

Request for your special attention and precautions in using the technical information and semiconductors described in this material

- (1) An export permit needs to be obtained from the competent authorities of the Japanese Government if any of the products or technical information described in this material and controlled under the "Foreign Exchange and Foreign Trade Law" is to be exported or taken out of Japan.
- (2) The technical information described in this material is limited to showing representative characteristics and applied circuits examples of the products. It neither warrants non-infringement of intellectual property right or any other rights owned by our company or a third party, nor grants any license.
- (3) We are not liable for the infringement of rights owned by a third party arising out of the use of the technical information as described in this material.
- (4) The products described in this material are intended to be used for standard applications or general electronic equipment (such as office equipment, communications equipment, measuring instruments and household appliances).
Consult our sales staff in advance for information on the following applications:
 - Special applications (such as for airplanes, aerospace, automobiles, traffic control equipment, combustion equipment, life support systems and safety devices) in which exceptional quality and reliability are required, or if the failure or malfunction of the products may directly jeopardize life or harm the human body.
 - Any applications other than the standard applications intended.
- (5) The products and product specifications described in this material are subject to change without notice for modification and/or improvement. At the final stage of your design, purchasing, or use of the products, therefore, ask for the most up-to-date Product Standards in advance to make sure that the latest specifications satisfy your requirements.
- (6) When designing your equipment, comply with the guaranteed values, in particular those of maximum rating, the range of operating power supply voltage, and heat radiation characteristics. Otherwise, we will not be liable for any defect which may arise later in your equipment.
Even when the products are used within the guaranteed values, take into the consideration of incidence of break down and failure mode, possible to occur to semiconductor products. Measures on the systems such as redundant design, arresting the spread of fire or preventing glitch are recommended in order to prevent physical injury, fire, social damages, for example, by using the products.
- (7) When using products for which damp-proof packing is required, observe the conditions (including shelf life and amount of time let standing of unsealed items) agreed upon when specification sheets are individually exchanged.
- (8) This material may be not reprinted or reproduced whether wholly or partially, without the prior written permission of Matsushita Electric Industrial Co., Ltd.