

IGBT - Field Stop

600 V, 40 A

FGH40N60SMD

Description

Using novel field stop IGBT technology, ON Semiconductor's new series of field stop 2nd generation IGBTs offer the optimum performance for solar inverter, UPS, welder, telecom, ESS and PFC applications where low conduction and switching losses are essential.

Features

- Maximum Junction Temperature : $T_J = 175^{\circ}\text{C}$
- Positive Temperature Co-efficient for Easy Parallel Operating
- High Current Capability
- Low Saturation Voltage: $V_{CE(sat)} = 1.9\text{ V (Typ) @ } I_C = 40\text{ A}$
- High Input Impedance
- Fast Switching: $E_{OFF} = 6.5\ \mu\text{J/A}$
- Tighten Parameter Distribution
- This Device is Pb-Free, Halogen Free/BFR Free and is RoHS Compliant

Applications

- Solar Inverter, Welder, UPS, PFC, Telecom, ESS



ON Semiconductor®

www.onsemi.com

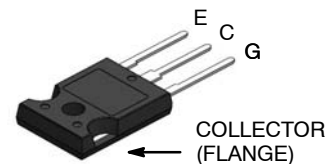
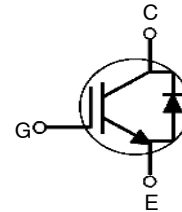

TO-247-3LD
CASE 340CK

MARKING DIAGRAMS

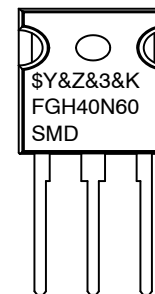

\$Y	= ON Semiconductor Logo
&Z	= Assembly Plant Code
&3	= Numeric Date Code
&K	= Lot Code
FGH40N60SMD	= Specific Device Code

ORDERING INFORMATION

See detailed ordering and shipping information in the package dimensions section on page 2 of this data sheet.

FGH40N60SMD

ABSOLUTE MAXIMUM RATINGS

Parameter	Symbol	Rated	Unit
Collector to Emitter Voltage	V_{CES}	600	V
Gate to Emitter Voltage	V_{GES}	± 20	V
Transient Gate to Emitter Voltage		± 30	V
Collector Current	I_C	$T_C = 25^\circ\text{C}$	80
Collector Current		$T_C = 100^\circ\text{C}$	40
Pulsed Collector Current (Note 1)	I_{CM}	$T_C = 25^\circ\text{C}$	120
Diode Forward Current	I_F	$T_C = 25^\circ\text{C}$	40
Diode Forward Current		$T_C = 100^\circ\text{C}$	20
Pulsed Diode Maximum Forward Current (Note 1)	I_{FM}		120
Maximum Power Dissipation	P_D	$T_C = 25^\circ\text{C}$	349
Maximum Power Dissipation		$T_C = 100^\circ\text{C}$	174
Operating Junction Temperature	T_J	-55 to +175	$^\circ\text{C}$
Storage Temperature Range	T_{stg}	-55 to +175	$^\circ\text{C}$
Maximum Lead Temp. for Soldering Purposes, 1/8" from Case for 5 Seconds	T_L	300	$^\circ\text{C}$

Stresses exceeding those listed in the Maximum Ratings table may damage the device. If any of these limits are exceeded, device functionality should not be assumed, damage may occur and reliability may be affected.

1. Repetitive rating: Pulse width limited by max. junction temperature.

THERMAL CHARACTERISTICS

Characteristic	Symbol	Value	Unit
Thermal Resistance, Junction to Case (IGBT)	$R_{\theta JC}$	0.43	$^\circ\text{C}/\text{W}$
Thermal Resistance, Junction to Case (Diode)	$R_{\theta JC}$	1.5	$^\circ\text{C}/\text{W}$
Thermal Resistance, Junction to Ambient	$R_{\theta JA}$	40	$^\circ\text{C}/\text{W}$

PACKAGE MARKING AND ORDERING INFORMATION

Part Number	Top Mark	Package	Packing Method	Reel Size	Tape Width	Quantity
FGH40N60SMD	FGH40N60SMD	TO-247-3LD	Tube	N/A	N/A	30

ELECTRICAL CHARACTERISTICS OF THE IGBT ($T_C = 25^\circ\text{C}$ unless otherwise noted)

Parameter	Symbol	Test Conditions	Min	Typ	Max	Unit
-----------	--------	-----------------	-----	-----	-----	------

OFF CHARACTERISTICS

Collector to Emitter Breakdown Voltage	BV_{CES}	$V_{GE} = 0\text{ V}, I_C = 250\ \mu\text{A}$	600	-	-	V
Temperature Coefficient of Breakdown Voltage	$\Delta BV_{CES} / \Delta T_J$	$V_{GE} = 0\text{ V}, I_C = 250\ \mu\text{A}$	-	0.6	-	$\text{V}/^\circ\text{C}$
Collector Cut-Off Current	I_{CES}	$V_{CE} = V_{CES}, V_{GE} = 0\text{ V}$	-	-	250	μA
G-E Leakage Current	I_{GES}	$V_{GE} = V_{GES}, V_{CE} = 0\text{ V}$	-	-	± 400	nA

ON CHARACTERISTICS

G-E Threshold Voltage	$V_{GE(th)}$	$I_C = 250\ \mu\text{A}, V_{CE} = V_{GE}$	3.5	4.5	6.0	V
Collector to Emitter Saturation Voltage	$V_{CE(sat)}$	$I_C = 40\text{ A}, V_{GE} = 15\text{ V}$	-	1.9	2.5	V
		$I_C = 40\text{ A}, V_{GE} = 15\text{ V}, T_C = 175^\circ\text{C}$	-	2.1	-	V

FGH40N60SMD

ELECTRICAL CHARACTERISTICS OF THE IGBT ($T_C = 25^\circ\text{C}$ unless otherwise noted) (continued)

Parameter	Symbol	Test Conditions	Min	Typ	Max	Unit
-----------	--------	-----------------	-----	-----	-----	------

DYNAMIC CHARACTERISTICS

Input Capacitance	C_{ies}	$V_{CE} = 30\text{ V}, V_{GE} = 0\text{ V},$ $f = 1\text{ MHz}$	–	1880	–	pF
Output Capacitance	C_{oes}		–	180	–	pF
Reverse Transfer Capacitance	C_{res}		–	50	–	pF

SWITCHING CHARACTERISTICS

Turn-On Delay Time	$t_{d(on)}$	$V_{CC} = 400\text{ V}, I_C = 40\text{ A},$ $R_G = 6\ \Omega, V_{GE} = 15\text{ V},$ Inductive Load, $T_C = 25^\circ\text{C}$	–	12	16	ns
Rise Time	t_r		–	20	28	ns
Turn-Off Delay Time	$t_{d(off)}$		–	92	120	ns
Fall Time	t_f		–	13	17	ns
Turn-On Switching Loss	E_{on}		–	0.87	1.30	mJ
Turn-Off Switching Loss	E_{off}		–	0.26	0.34	mJ
Total Switching Loss	E_{ts}		–	1.13	1.64	mJ
Turn-On Delay Time	$t_{d(on)}$	$V_{CC} = 400\text{ V}, I_C = 40\text{ A},$ $R_G = 6\ \Omega, V_{GE} = 15\text{ V},$ Inductive Load, $T_C = 175^\circ\text{C}$	–	15	–	ns
Rise Time	t_r		–	22	–	ns
Turn-Off Delay Time	$t_{d(off)}$		–	116	–	ns
Fall Time	t_f		–	16	–	ns
Turn-On Switching Loss	E_{on}		–	0.97	–	mJ
Turn-Off Switching Loss	E_{off}		–	0.60	–	mJ
Total Switching Loss	E_{ts}		–	1.57	–	mJ
Total Gate Charge	Q_g	$V_{CE} = 400\text{ V}, I_C = 40\text{ A},$ $V_{GE} = 15\text{ V}$	–	119	180	nC
Gate to Emitter Charge	Q_{ge}		–	13	20	nC
Gate to Collector Charge	Q_{gc}		–	58	90	nC

ELECTRICAL CHARACTERISTICS OF THE DIODE ($T_C = 25^\circ\text{C}$ unless otherwise noted)

Parameter	Symbol	Test Conditions	Min	Typ	Max	Unit	
Diode Forward Voltage	V_{FM}	$I_F = 20\text{ A}$	$T_C = 25^\circ\text{C}$	–	2.3	2.8	V
			$T_C = 175^\circ\text{C}$	–	1.67	–	V
Reverse Recovery Energy	E_{rec}	$I_F = 20\text{ A},$ $di_F/dt = 200\text{ A}/\mu\text{s},$	$T_C = 175^\circ\text{C}$	–	48.9	–	μJ
Diode Reverse Recovery Time	t_{rr}		$T_C = 25^\circ\text{C}$	–	36	–	ns
			$T_C = 175^\circ\text{C}$	–	110	–	ns
Diode Reverse Recovery Charge	Q_{rr}		$T_C = 25^\circ\text{C}$	–	46.8	–	nC
			$T_C = 175^\circ\text{C}$	–	445	–	nC

Product parametric performance is indicated in the Electrical Characteristics for the listed test conditions, unless otherwise noted. Product performance may not be indicated by the Electrical Characteristics if operated under different conditions.

FGH40N60SMD

TYPICAL PERFORMANCE CHARACTERISTICS

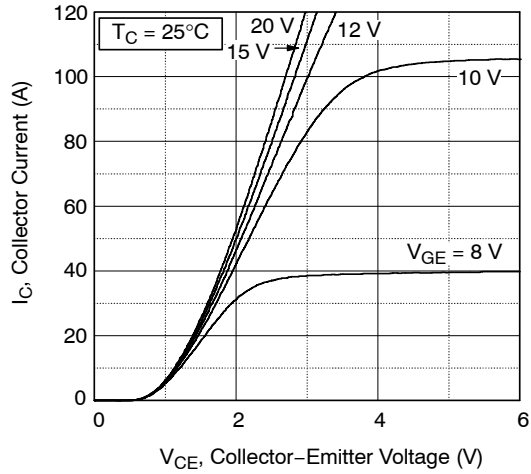

Figure 1. Typical Output Characteristics

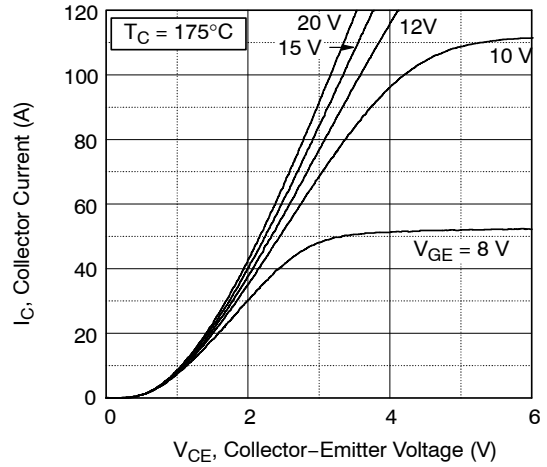

Figure 2. Typical Output Characteristics

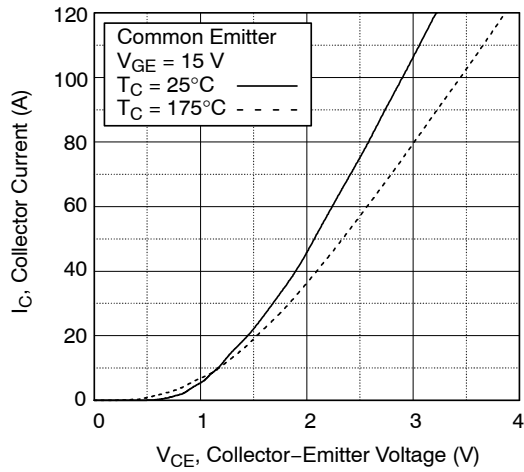

Figure 3. Typical Saturation Voltage Characteristics

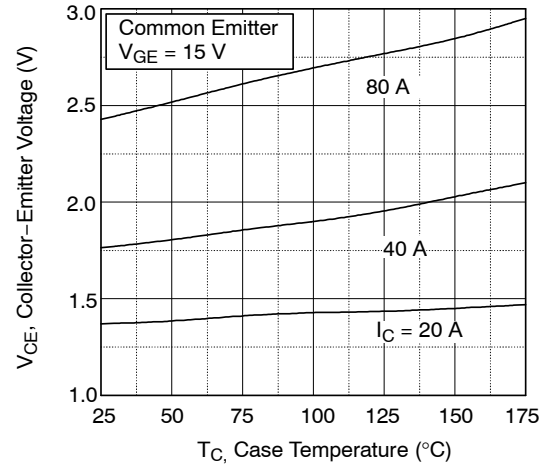

Figure 4. Saturation Voltage vs. Case Temperature at Variant Current Level

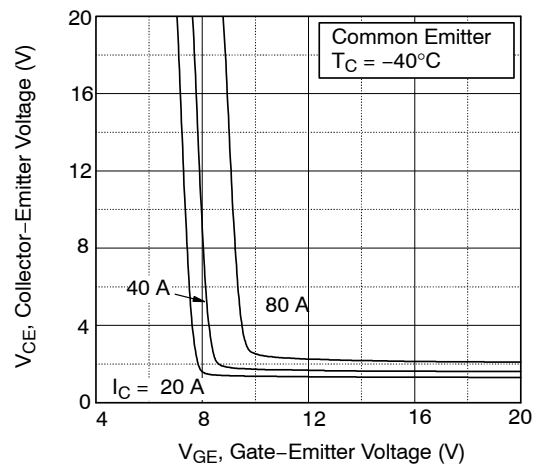

Figure 5. Saturation Voltage vs. V_{GE}

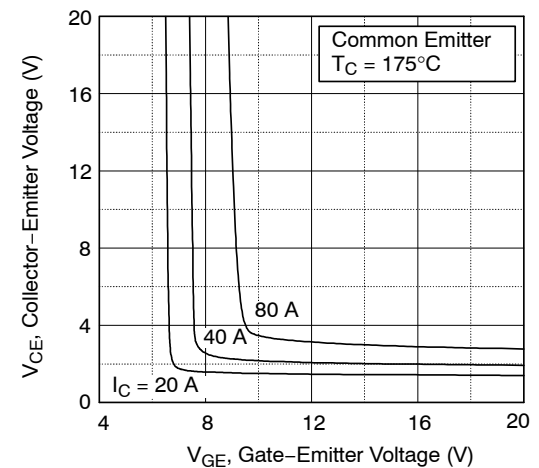

Figure 6. Saturation Voltage vs V_{GE}

FGH40N60SMD

TYPICAL PERFORMANCE CHARACTERISTICS (continued)

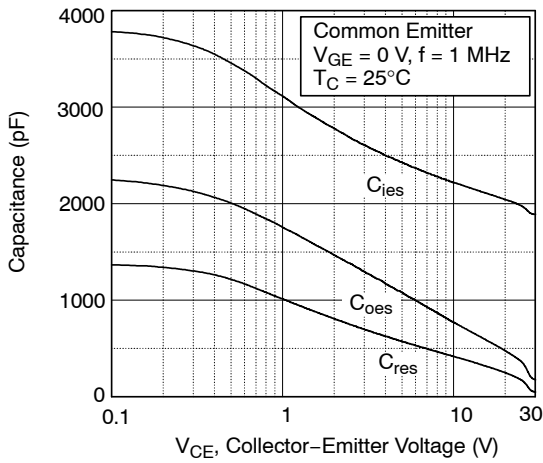

Figure 7. Capacitance Characteristics

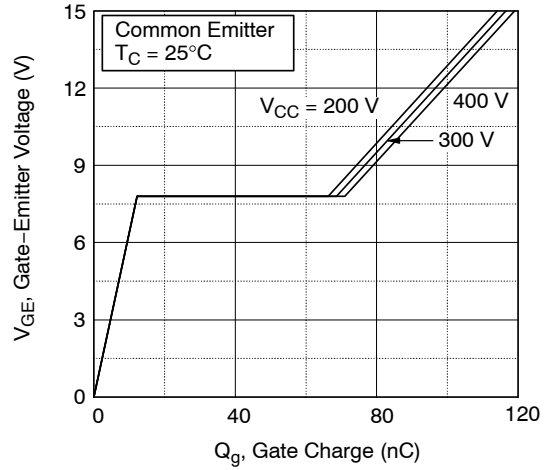

Figure 8. Gate Charge Characteristics

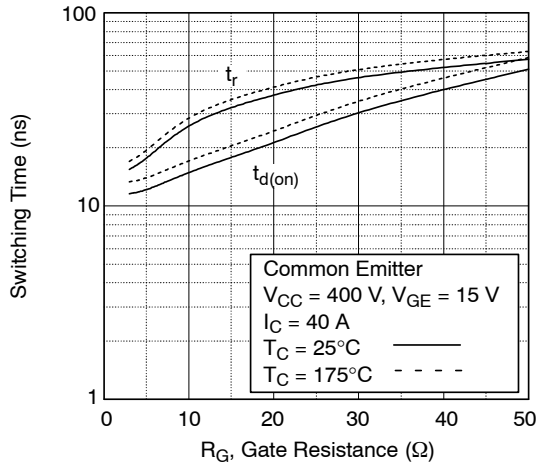

Figure 9. Turn-On Characteristics vs. Gate Resistance

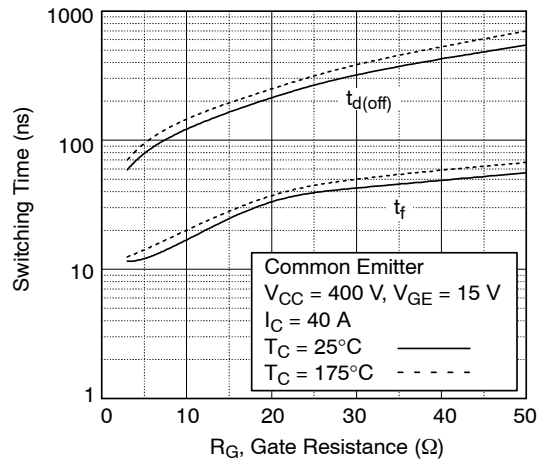

Figure 10. Turn-Off Characteristics vs. Gate Resistance

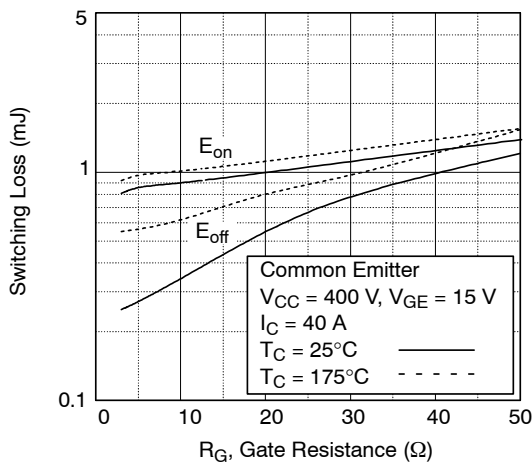

Figure 11. Switching Loss vs. Gate Resistance

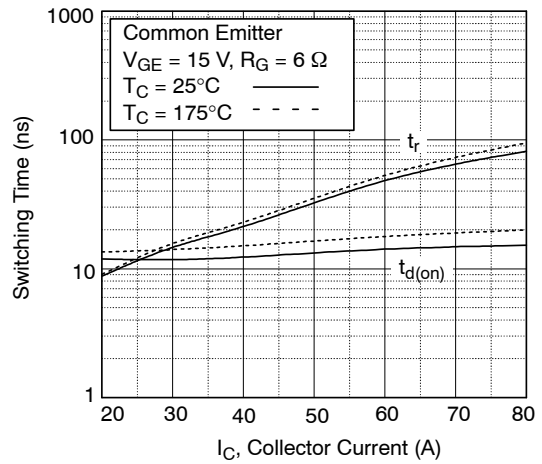

Figure 12. Turn-On Characteristics vs. Collector Current

TYPICAL PERFORMANCE CHARACTERISTICS (continued)

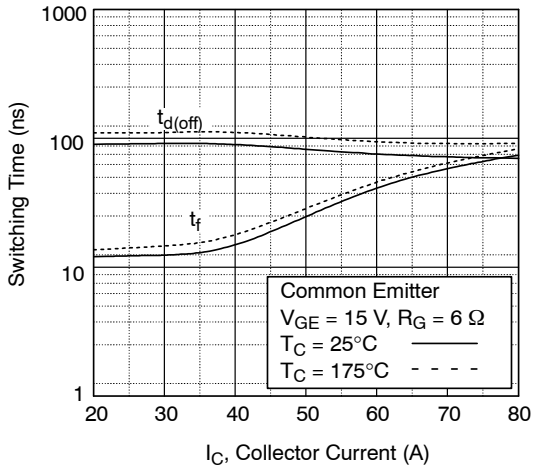

Figure 13. Turn-Off Characteristics vs. Collector Current

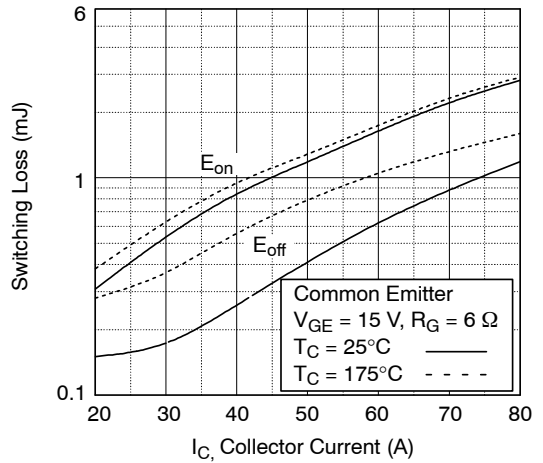

Figure 14. Switching Loss vs. Collector Current

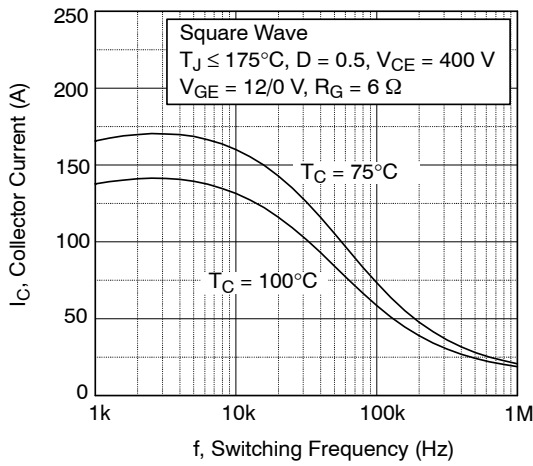

Figure 15. Load Current vs. Frequency

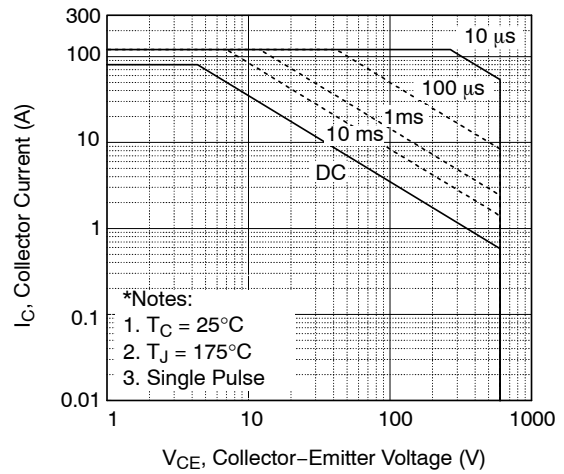

Figure 16. SOA Characteristics

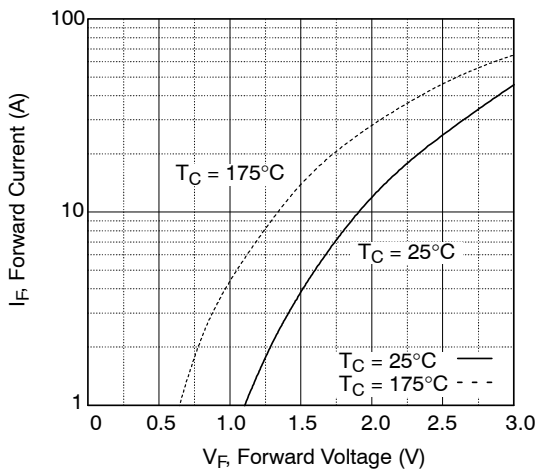

Figure 17. Forward Characteristics

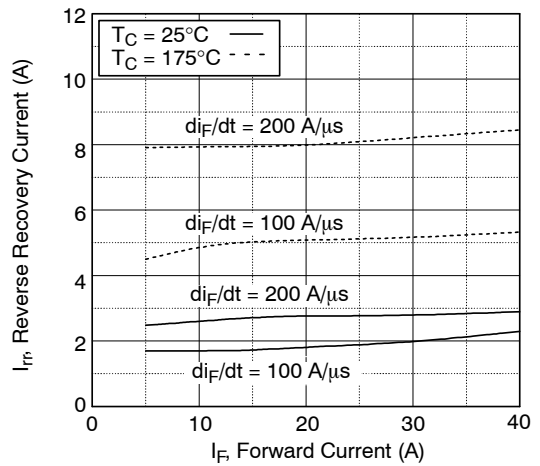

Figure 18. Reverse Recovery Current

FGH40N60SMD

TYPICAL PERFORMANCE CHARACTERISTICS (continued)

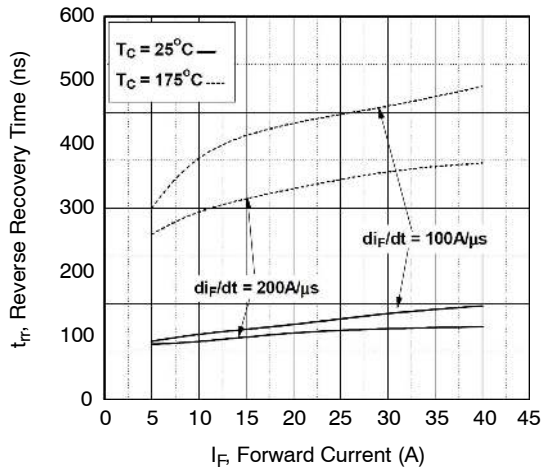

Figure 19. Reverse Recovery Time

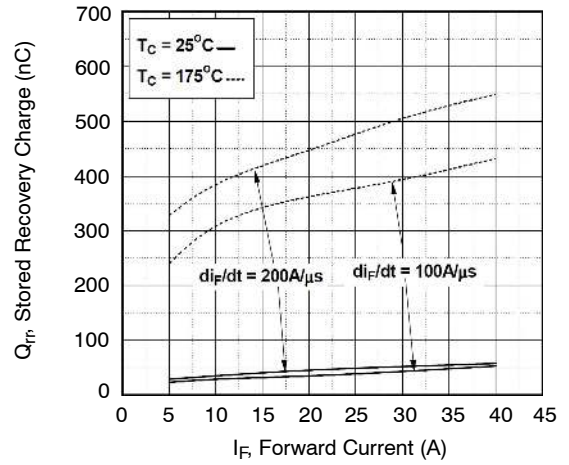

Figure 20. Stored Charge

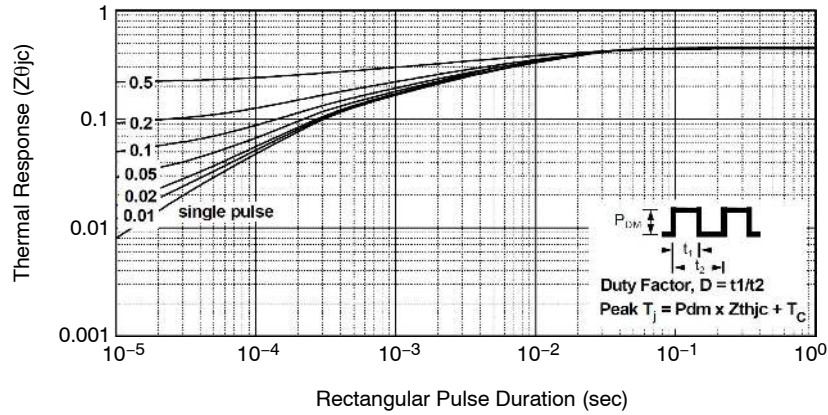

Figure 21. Transient Thermal Impedance of IGBT

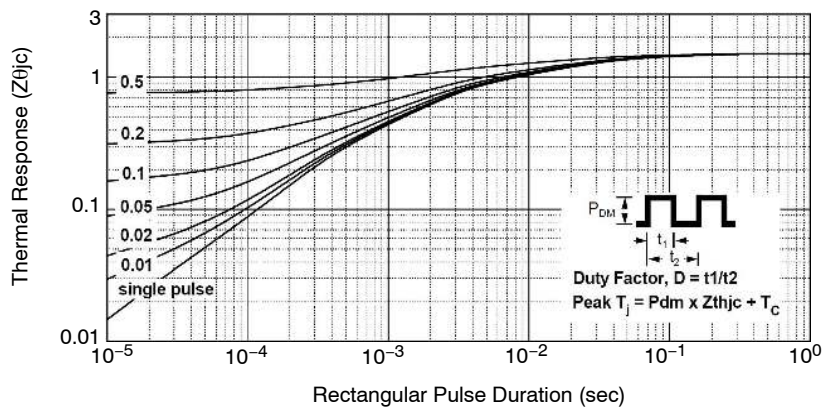
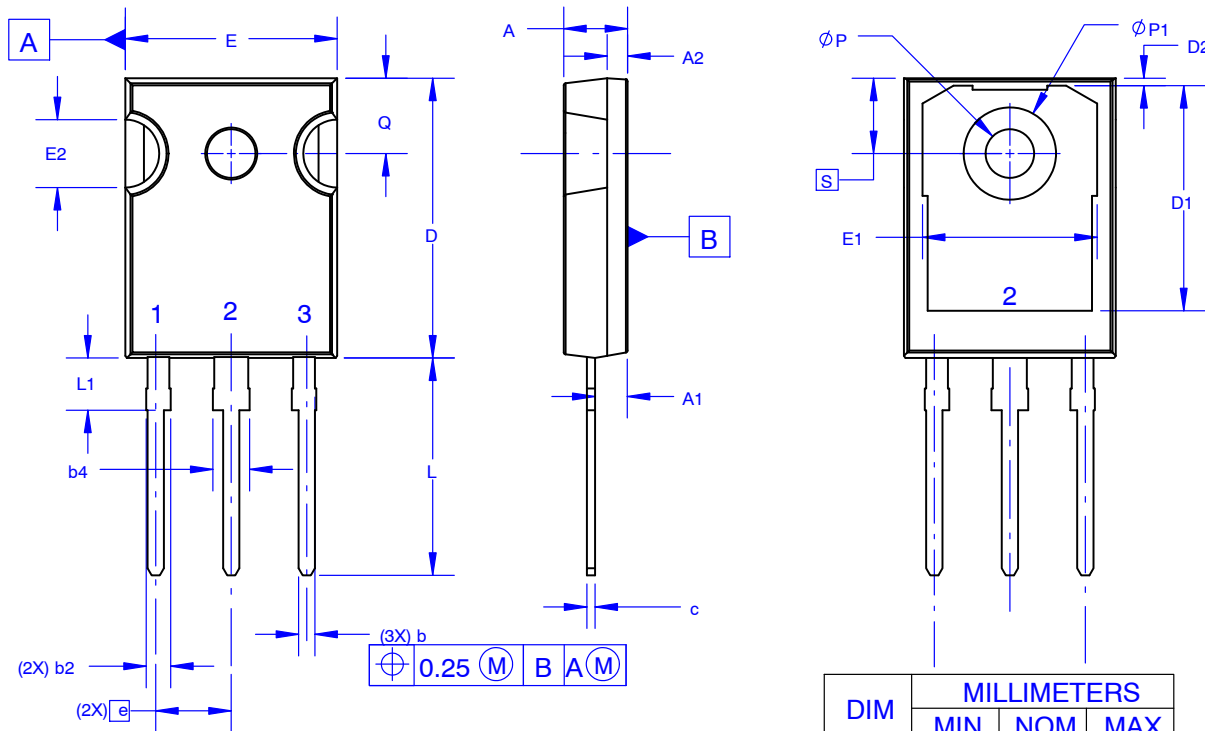

Figure 22. Time Transient Thermal Impedance of Diode



TO-247-3LD SHORT LEAD
CASE 340CK
ISSUE A

DATE 31 JAN 2019



NOTES: UNLESS OTHERWISE SPECIFIED.

- A. DIMENSIONS ARE EXCLUSIVE OF BURRS, MOLD FLASH, AND TIE BAR EXTRUSIONS.
- B. ALL DIMENSIONS ARE IN MILLIMETERS.
- C. DRAWING CONFORMS TO ASME Y14.5 - 2009.
- D. DIMENSION A1 TO BE MEASURED IN THE REGION DEFINED BY L1.
- E. LEAD FINISH IS UNCONTROLLED IN THE REGION DEFINED BY L1.

GENERIC MARKING DIAGRAM*

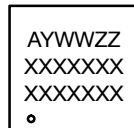

- XXXX = Specific Device Code
- A = Assembly Location
- Y = Year
- WW = Work Week
- ZZ = Assembly Lot Code

*This information is generic. Please refer to device data sheet for actual part marking. Pb-Free indicator, "G" or microdot "•", may or may not be present. Some products may not follow the Generic Marking.

DIM	MILLIMETERS		
	MIN	NOM	MAX
A	4.58	4.70	4.82
A1	2.20	2.40	2.60
A2	1.40	1.50	1.60
b	1.17	1.26	1.35
b2	1.53	1.65	1.77
b4	2.42	2.54	2.66
c	0.51	0.61	0.71
D	20.32	20.57	20.82
D1	13.08	~	~
D2	0.51	0.93	1.35
E	15.37	15.62	15.87
E1	12.81	~	~
E2	4.96	5.08	5.20
e	~	5.56	~
L	15.75	16.00	16.25
L1	3.69	3.81	3.93
ØP	3.51	3.58	3.65
ØP1	6.60	6.80	7.00
Q	5.34	5.46	5.58
S	5.34	5.46	5.58

DOCUMENT NUMBER:	98AON13851G	Electronic versions are uncontrolled except when accessed directly from the Document Repository. Printed versions are uncontrolled except when stamped "CONTROLLED COPY" in red.
DESCRIPTION:	TO-247-3LD SHORT LEAD	PAGE 1 OF 1

ON Semiconductor and are trademarks of Semiconductor Components Industries, LLC dba ON Semiconductor or its subsidiaries in the United States and/or other countries. ON Semiconductor reserves the right to make changes without further notice to any products herein. ON Semiconductor makes no warranty, representation or guarantee regarding the suitability of its products for any particular purpose, nor does ON Semiconductor assume any liability arising out of the application or use of any product or circuit, and specifically disclaims any and all liability, including without limitation special, consequential or incidental damages. ON Semiconductor does not convey any license under its patent rights nor the rights of others.

onsemi, **Onsemi**, and other names, marks, and brands are registered and/or common law trademarks of Semiconductor Components Industries, LLC dba "**onsemi**" or its affiliates and/or subsidiaries in the United States and/or other countries. **onsemi** owns the rights to a number of patents, trademarks, copyrights, trade secrets, and other intellectual property. A listing of **onsemi**'s product/patent coverage may be accessed at www.onsemi.com/site/pdf/Patent-Marking.pdf. **onsemi** reserves the right to make changes at any time to any products or information herein, without notice. The information herein is provided "as-is" and **onsemi** makes no warranty, representation or guarantee regarding the accuracy of the information, product features, availability, functionality, or suitability of its products for any particular purpose, nor does **onsemi** assume any liability arising out of the application or use of any product or circuit, and specifically disclaims any and all liability, including without limitation special, consequential or incidental damages. Buyer is responsible for its products and applications using **onsemi** products, including compliance with all laws, regulations and safety requirements or standards, regardless of any support or applications information provided by **onsemi**. "Typical" parameters which may be provided in **onsemi** data sheets and/or specifications can and do vary in different applications and actual performance may vary over time. All operating parameters, including "Typicals" must be validated for each customer application by customer's technical experts. **onsemi** does not convey any license under any of its intellectual property rights nor the rights of others. **onsemi** products are not designed, intended, or authorized for use as a critical component in life support systems or any FDA Class 3 medical devices or medical devices with a same or similar classification in a foreign jurisdiction or any devices intended for implantation in the human body. Should Buyer purchase or use **onsemi** products for any such unintended or unauthorized application, Buyer shall indemnify and hold **onsemi** and its officers, employees, subsidiaries, affiliates, and distributors harmless against all claims, costs, damages, and expenses, and reasonable attorney fees arising out of, directly or indirectly, any claim of personal injury or death associated with such unintended or unauthorized use, even if such claim alleges that **onsemi** was negligent regarding the design or manufacture of the part. **onsemi** is an Equal Opportunity/Affirmative Action Employer. This literature is subject to all applicable copyright laws and is not for resale in any manner.

ADDITIONAL INFORMATION

TECHNICAL PUBLICATIONS:

Technical Library: www.onsemi.com/design/resources/technical-documentation
onsemi Website: www.onsemi.com

ONLINE SUPPORT: www.onsemi.com/support

For additional information, please contact your local Sales Representative at www.onsemi.com/support/sales