

10 9 8 7 6 5 4 3 2 1

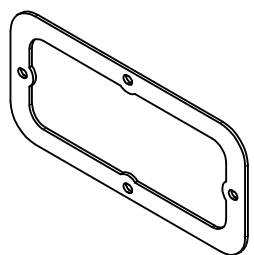

850710016

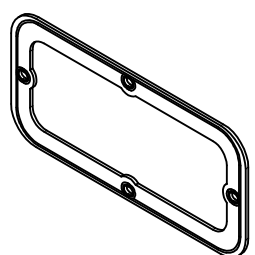
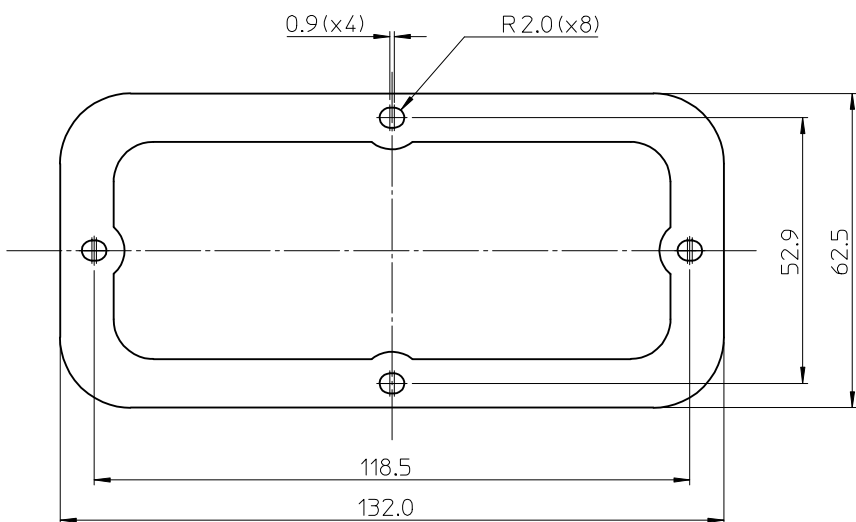
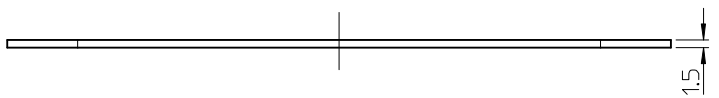

850710017

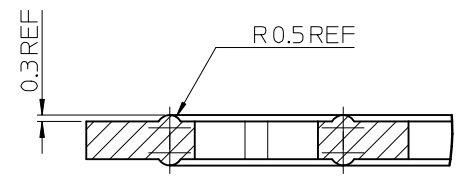

DETAIL 1

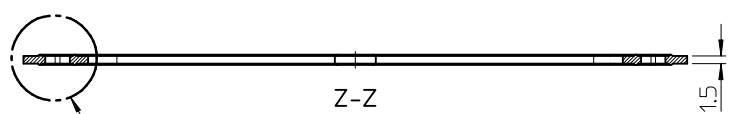

SEE DETAIL 1

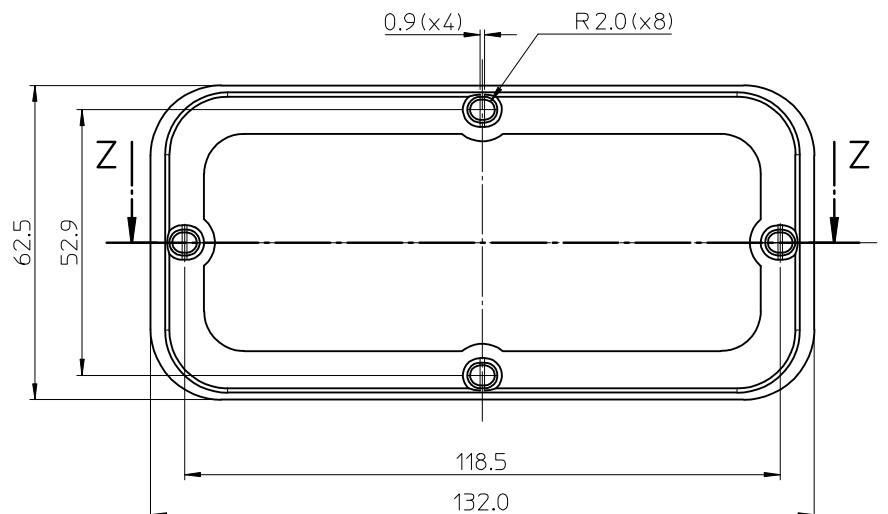

PART NUMBER	MATERIAL	COLOUR
850710016	FLUOROELASTOMER	BLACK
850710017	SILICONE RUBBER	RED

NOTES:  
 1. MATERIAL: SEE TABLE  
 2. PACKAGING SPECIFICATION: PK-85071-002

ORIGINAL RELEASE  
 EC NO: IPG2012-0350  
 DRW: DSHEA 2012/02/03  
 CHKD:  
 APPR: EFOLAN 2012/05/22

QUALITY SYMBOLS  
 = 0  
 = 0

GENERAL TOLERANCES (UNLESS SPECIFIED)

	mm	INCH
4 PLACES	± ---	± ---
3 PLACES	± ---	± ---
2 PLACES	± 0.20	± ---
1 PLACE	± 0.5	± ---
ANGULAR ± .5 °		

DRAFT WHERE APPLICABLE MUST REMAIN WITHIN DIMENSIONS

DIMENSION STYLE  
**MM ONLY**

SCALE  
**1:1**

DESIGN UNITS  
**METRIC**

THIRD ANGLE PROJECTION

TITLE  
**SRC FLANGE GASKET**

MOLEX INCORPORATED

DOCUMENT NO.  
**SD-85071-016**

SHEET NO.  
**1 OF 1**

THIS DRAWING CONTAINS INFORMATION THAT IS PROPRIETARY TO MOLEX INCORPORATED AND SHOULD NOT BE USED WITHOUT WRITTEN PERMISSION

9 8 7 6 5 4 3 2 1