

bq2084EVM-001 SBS 1.1 Battery Management Solution Evaluation Module

User's Guide



Literature Number: SLUU184B
November 2005—Revised October 2013

1	bq2084EVM-001 SBS 1.1 Battery Management Solution Evaluation Module	4
1	INTRODUCTION	4
1.1	FEATURES	4
1.2	KIT CONTENTS	4
1.3	ORDERING INFORMATION	4
2	bq2084/bq29312-BASED CIRCUIT MODULE	5
2.1	CIRCUIT MODULE CONNECTIONS	5
2.2	PIN DESCRIPTIONS	5
3	bq2084/bq29312 CIRCUIT MODULE SCHEMATIC	6
3.1	PREVIEW SCHEMATIC	6
3.2	MODIFICATIONS FOR CHOOSING PARTICULAR PRECHARGE MODE	7
3.3	TESTING FUSE-BLOWING CIRCUIT	7
4	CIRCUIT MODULE PHYSICAL LAYOUTS AND BILL OF MATERIALS	7
4.1	BOARD LAYOUT	7
4.2	BILL OF MATERIALS	10
4.3	bq2084/bq29312/bq29401 CIRCUIT MODULE PERFORMANCE SPECIFICATION SUMMARY	11
5	EVM HARDWARE AND SOFTWARE SETUP	11
5.1	SYSTEM REQUIREMENTS	11
5.2	SOFTWARE INSTALLATION	11
5.3	HARDWARE CONNECTION	12
6	OPERATION	14
6.1	STARTING THE PROGRAM	14
6.2	SETTING PROGRAMMABLE bq2084 and bq29312 OPTIONS	15
6.3	CALIBRATION OF A bq2084/bq29312/bq29401-BASED MODULE USING THE EV2300-84 SOFTWARE	16
6.4	DIRECT ACCESS COMMUNICATION	18

List of Figures

1	bq2084/bq29312/bq29401 EVM Schematic	6
2	bq2084EVM-001 Layout	7
3	Top Assembly	8
4	Layer 1	8
5	Layer 2 (Internal 1)	8
6	Layer 3 (Internal 2)	9
7	Layer 4	9
8	Bottom Assembly	9
9	bq2084/bq29312 Circuit Module Connection to Cells and System Load/Charger	12
10	SBS Data Screen	14
11	SBS Data Screen - Status Bit Window	14
12	Data Flash Screen, AFE Configuration, and Module Calibration Locations	16
13	Calibration Screen	17
14	Pro Screen	18

List of Tables

1	Ordering Information	4
2	Components and Flash-Memory Settings for Different Precharge Modes	7
3	Bill of Materials	10
4	Performance Specification Summary	11
5	Circuit Module to EV2300 Connections	12
6	Example Log File	15
7	Example Log File	15

bq2084EVM-001 SBS 1.1 Battery Management Solution Evaluation Module

1 INTRODUCTION

This EVM is a complete evaluation system for the bq2084/bq29312/bq29401 battery management system. The EVM includes one bq2084/bq29312/ bq29401 circuit module, a current sense resistor, a thermistor and Windows®- based PC software. The circuit module includes one bq2084 IC, one bq29312 IC, one bq29401 IC, and all other onboard components necessary to monitor and predict capacity, perform cell balancing, monitor critical parameters, protect the cells from overcharge, over discharge, short circuit, and overcurrent in 2-, 3- or 4-series cell Li-Ion or Li-Polymer battery packs. The circuit module connects directly across the cells in a battery. An EV2300 board for gas gauge interface is required to interface this EVM with the PC and can be purchased separately. With the EV2300 interface board and software, the user can read the bq2084 data registers, program the chipset for different pack configurations, log cycling data for further evaluation and evaluate the overall functionality of the bq2084/bq29312/bq29401 solution under different charge and discharge conditions.

1.1 FEATURES

- Complete evaluation system for the bq2084 SBS 1.1-compliant advanced gas gauge, bq29312 analog front end and protection IC, and bq29401 independent overvoltage protection IC
- Populated circuit module for quick setup
- PC software and interface board for easy evaluation
- Software that allows data logging for system analysis

1.2 KIT CONTENTS

- bq2084/bq29312/bq29401 circuit module
- Software CD with the evaluation software
- Set of support documentation

1.3 ORDERING INFORMATION

Table 1. Ordering Information

EVM PART NUMBER	CHEMISTRY	CONFIGURATION	CAPACITY
bq2084EVM-001	Li-Ion	2, 3, or 4 cell	Any

2 bq2084/bq29312-BASED CIRCUIT MODULE

The bq2084/bq29312/bq29401-based circuit module is a complete and compact example solution of a bq2084 and bq29312 circuit for battery management and protection of Li-Ion or Li-Polymer packs. The circuit module incorporates a bq2084 battery monitor IC, bq29312 AFE and protection IC, bq29401 independent overvoltage protection IC, and all other components necessary to accurately predict the capacity of 2-, 3-, or 4-series cells.

2.1 CIRCUIT MODULE CONNECTIONS

Contacts on the circuit module provide the following connections:

- Direct connection to the cells: 1N (BAT-), 1P, 2P, 3P, 4P (BAT+)
- To the serial communications port (SMBC, SMBD).
- The system load and charger connect across PACK+ and PACK-.
- To the system present pin (SYS PRES)
- To the sleep pin (SLEEP)

2.2 PIN DESCRIPTIONS

1N	-ve connection of first (bottom) cell
1P	+ve connection of first (bottom) cell
2P	+ve connection of second cell
3P	+ve connection of third cell
4P	+ve connection of fourth (top) cell
SMBC	Serial communication port clock
SMBD	Serial communication data port
SYS PRES	System present pin (if low, system is present)
SLEEP	Sleep mode pin (if high, AFE enters sleep mode)
PACK-	Pack negative terminal
VSS	Pack negative terminal
PACK+	Pack positive terminal

3 bq2084/bq29312 CIRCUIT MODULE SCHEMATIC

This chapter contains a preview schematic (thumbnail) of the circuit for the bq2084/bq29312/bq29401 implementation.

3.1 PREVIEW SCHEMATIC

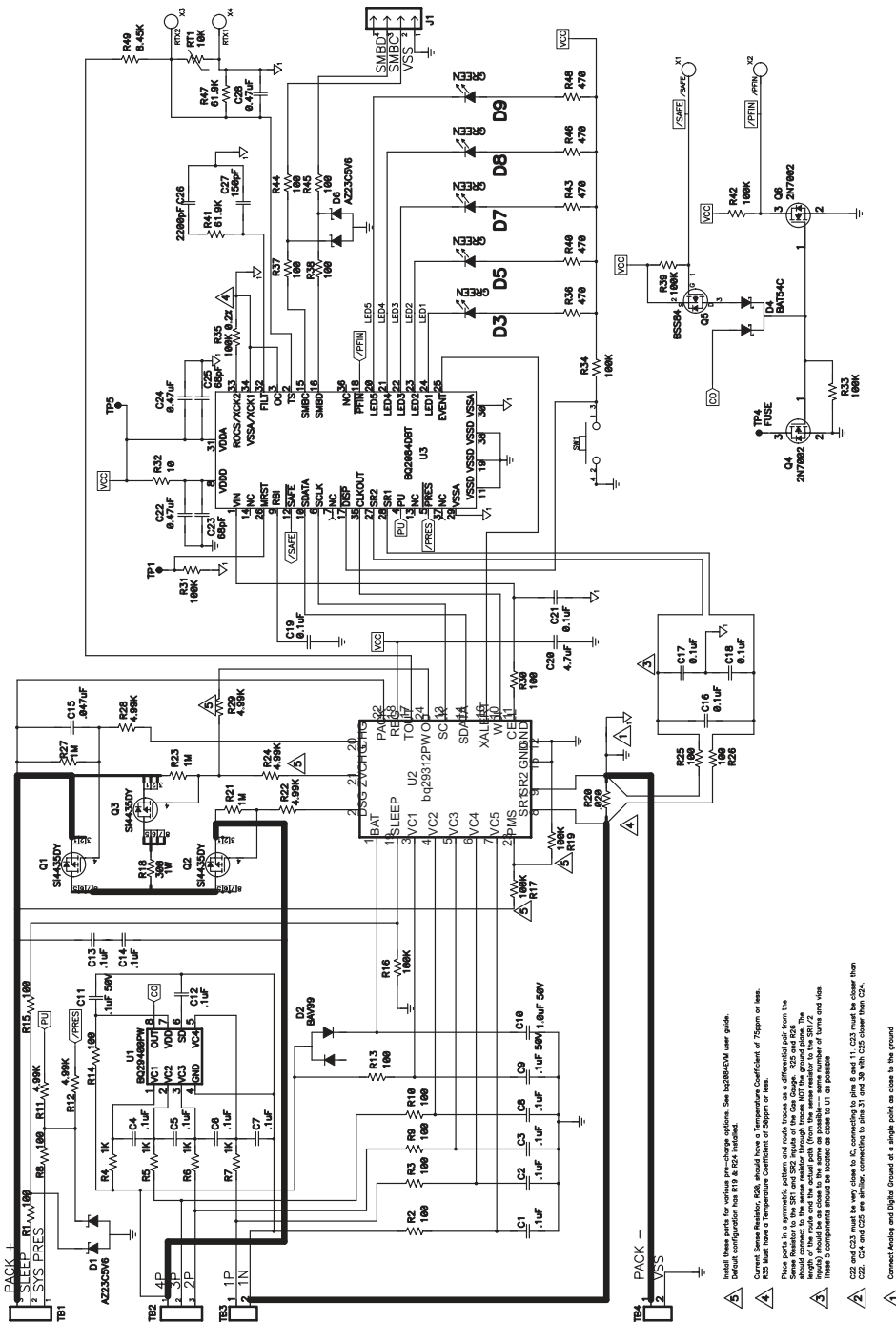

Figure 1. bq2084/bq29312/bq29401 EVM Schematic

NOTE: Refer to the back of the user's guide for the full-size schematic.

3.2 MODIFICATIONS FOR CHOOSING PARTICULAR PRECHARGE MODE

In order to charge, the charge FET (CHG-FET) must be turned on to create a current path. When the V(BAT) is 0 V and CHG-FET = ON, the V(PACK) is as low as the battery voltage. In this case, the supply voltage for the device is too low to operate. There are 3 possible configurations for this function, and the bq29312 can be easily configured according to the application needs. The 3 modes are 0-V Charge FET Mode, Common FET Mode, and Precharge FET Mode.

1. 0-V Charge FET Mode – Dedicates a precharge current path using an additional FET (ZVCHG-FET) to sustain the PACK+ voltage level. The host charger is expected to provide a precharge function.
2. Common FET Mode – Does not use a dedicated precharge FET. The charge FET (CHG-FET) is set to ON state as default. The charger is expected to provide a precharge function.
3. Precharge FET Mode – Dedicates a precharge current path using an additional open drain (OD) pin drive FET (PCHG-FET) FET to sustain the PACK+ voltage level. The charger does not provide any precharge function.

To use a particular mode of charging with the EVM, add or remove some elements shown in Table 2, and use the given settings of Flash memory, Misc Configuration DF 0x2a (high) and 0x2b (low), bits PFET1, PFET0.

Table 2. Components and Flash-Memory Settings for Different Precharge Modes

MODE	RESISTORS	FET	PFET1	FET0
1(default)	R19,R24	Q3, SI4435DY	0	0
2	R17	-	0	1
3	R19,R24	Q3, open drain FET	1	0

For more details about precharge operation and mode choices, see the bq29312 data sheet at <http://www-s.ti.com/sc/ds/bq29312.pdf>.

3.3 TESTING FUSE-BLOWING CIRCUIT

To prevent the loss of board functionality during the fuse-blowing test, the actual chemical fuse is not provided in the circuit. FET Q4 drives TP4 low if fuse blow condition occurs, so monitoring TP4 can be used to test this condition. Fuse placement on the application board is shown in the bq2084 data sheet reference-board schematic.

4 CIRCUIT MODULE PHYSICAL LAYOUTS AND BILL OF MATERIALS

This chapter contains the board layout, bill of materials, and assembly drawings for the bq2084/ bq29312/ bq29401 circuit module.

4.1 BOARD LAYOUT

Figure 2 shows the dimensions, PCB layers, and assembly drawing for the bq2084/bq29312 module.

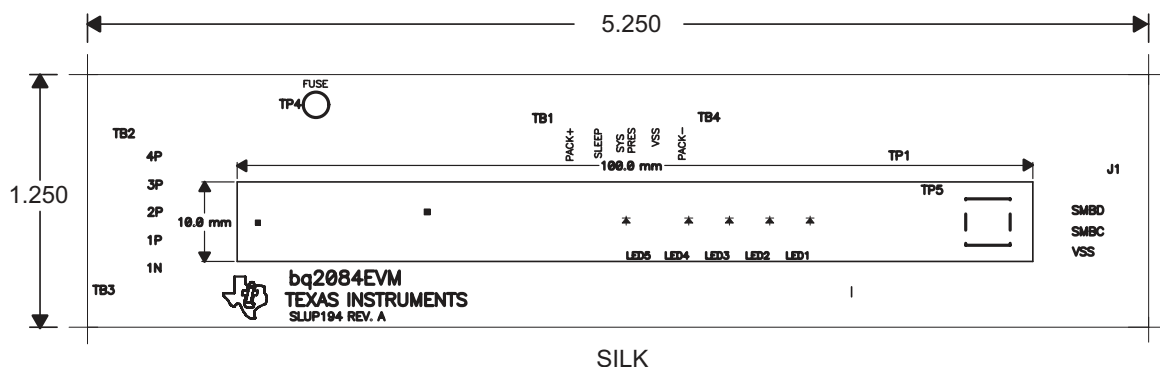
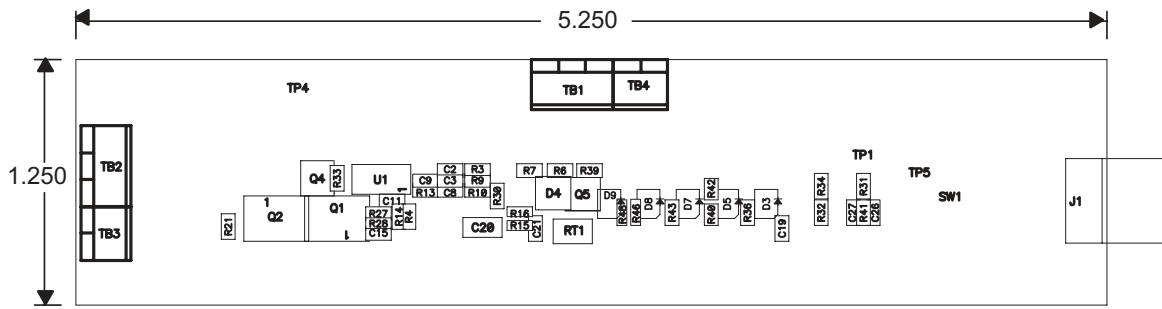
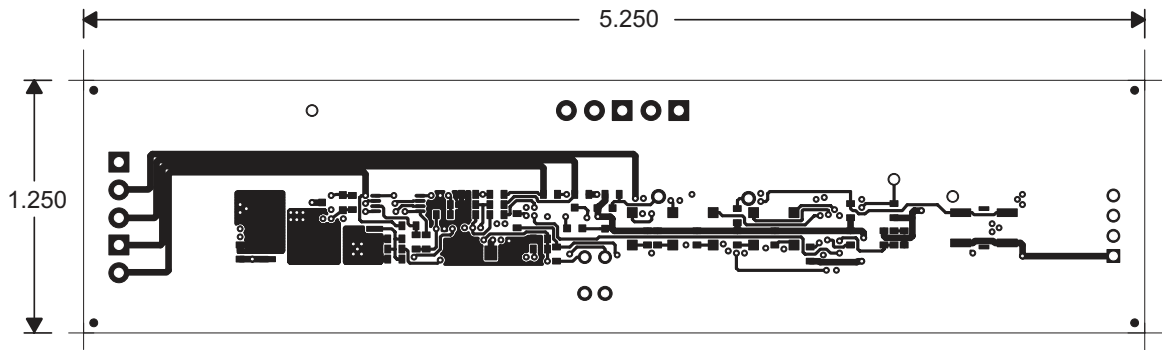

Figure 2. bq2084EVM-001 Layout



SLUP194 REV. A TOP ASSY

Figure 3. Top Assembly



LAYER 1

Figure 4. Layer 1

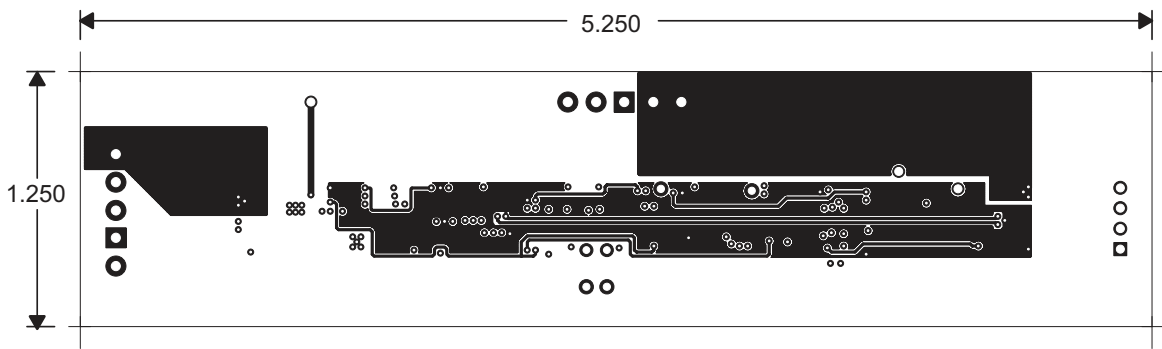

LAYER 2 [INTERNAL 1]

Figure 5. Layer 2 (Internal 1)

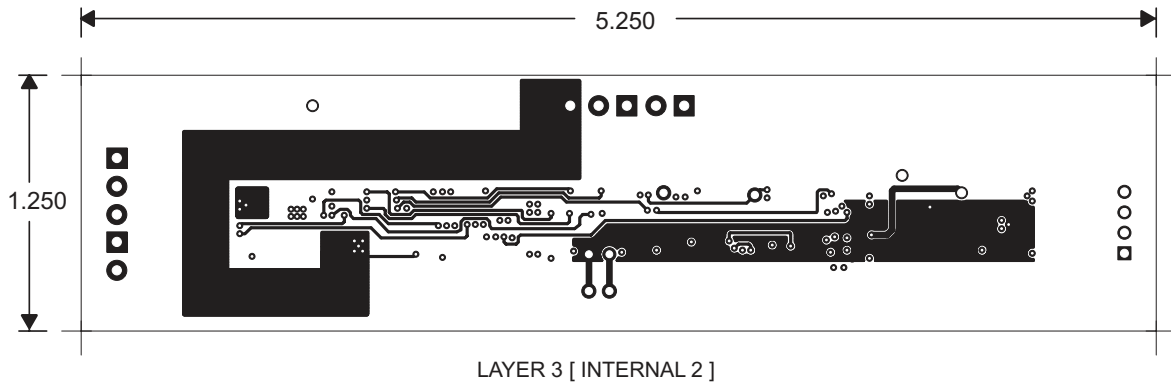

LAYER 3 [INTERNAL 2]
Figure 6. Layer 3 (Internal 2)

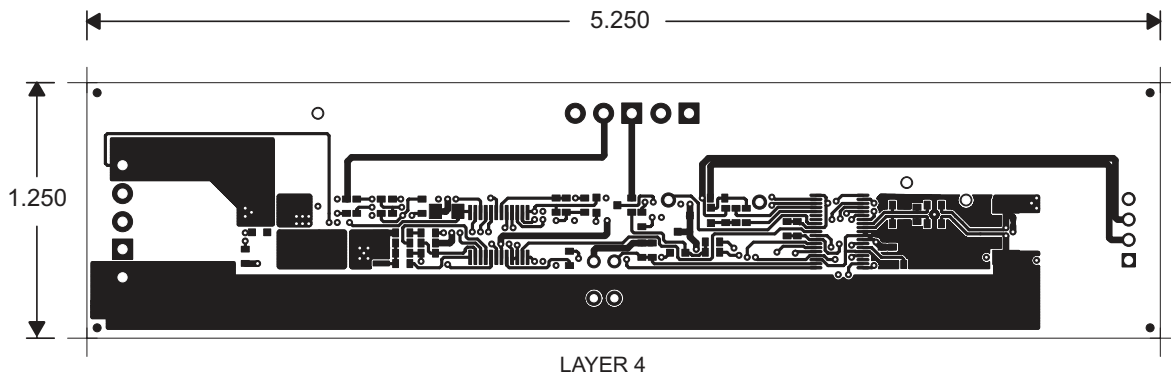

LAYER 4
Figure 7. Layer 4

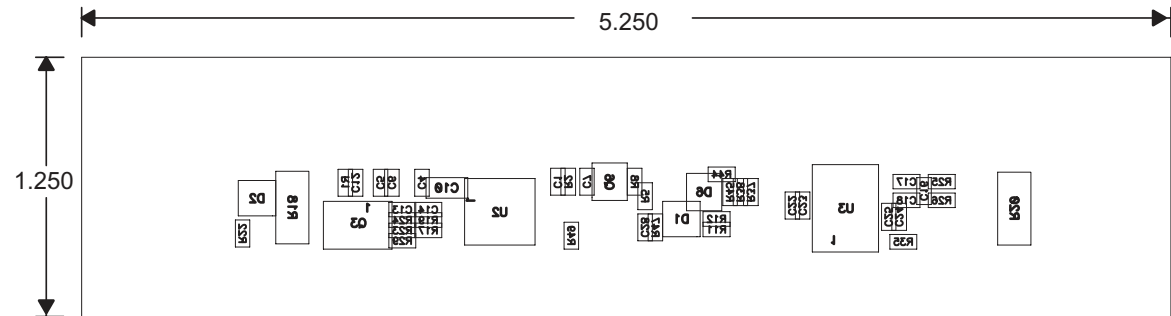

SLUP194 REV. A BOTTOM ASSY
Figure 8. Bottom Assembly

4.2 BILL OF MATERIALS^{(1) (2) (3)}

- (1) This assembly is ESD sensitive.
(2) This assembly shall comply with IPC-A-610 class 2 or better.
(3) This assembly must be clean of flux residues and contaminants. Use of no-clean flux is not acceptable.

Table 3. Bill of Materials

COUNT	REF DES	DESCRIPTION	SIZE	VALUE	MFG PART NO.
18	C1, C2, C3, C4, C5, C6, C7, C8, C9, C11, C12, C13, C14, C16, C17, C18, C19, C21	Capacitor, ceramic, 50 V, X7R, 20%	603	0.1 μ F	
1	C10	Capacitor, ceramic, 50 V, X7R, 20%	1206	1.0 μ F	
1	C15	Capacitor, ceramic, 50 V, X7R, 10%	603	0.047 μ F	
1	C20	Capacitor, ceramic, 16 V, X7R, 10%	1206	4.7 μ F	
3	C22, C24, C28	Capacitor, ceramic, 16 V, X7R, 10%	603	0.47 μ F	
2	C23, C25	Capacitor, ceramic, 16 V, COG, 10%	603	68 pF	
1	C26	Capacitor, ceramic, 16 V, COG, 10%	603	2200 pF	
1	C27	Capacitor, ceramic, 16 V, COG, 10%	603	150 pF	
2	D1, D6	Diode, dual, Zener, 5.6 V, 300 mW	SOT23		AZ23C5V6
1	D2	Diode, dual ultra fast, series, 200 mA, 70 V	SOT23		BAV99
5	D3, D5, D7, D8, D9	Diode, LED, green, Gullwing, GW type, 20 mA, 7.5 mcd Typ	Gullwing		LN1361C
1	D4	Diode, dual Schottky, 200 mA, 30 V	SOT23		BAT54C
1	J1	Header, friction lock assembly, 4-pin right angle	0.400 \times 0.500		22-05-3041
3	Q1, Q2, Q3	MOSFET, P-ch, 30 V, 7.0 A, 20 m Ω	SO8		Si4435DY
2	Q4, Q6	MOSFET, N-ch, 60 V, 115 mA, 1.2 Ω	SOT23		2N7002
1	Q5	MOSFET, P-ch, 50 V, 130 mA, 10 Ω	SOT23		BSS84
16	R1, R2, R3, R8, R9, R10, R13, R14, R15, R25, R26, R30, R37, R38, R44, R45	Resistor, chip, 1/16 W, 5%	603	100 Ω	
6	R11, R12, R22, R24, R28, R29	Resistor, chip, 1/16 W, 1%	603	4.99 k Ω	
8	R16, R17, R19, R31, R33, R34, R39, R42	Resistor, chip, 1/16 W, 5%	603	100 k Ω	
1	R18	Resistor, chip, 1 W, 5%	2512	300 Ω	
1	R20	Resistor, chip, 1 W, 1%	2512	0.02 Ω	
3	R21, R23, R27	Resistor, chip, 1/16 W, 5%	603	1 M Ω	
1	R32	Resistor, chip, 1/16 W, 5%	603	10 Ω	
1	R35**	Resistor, chip, 1/16 W, 0.2%, 75 PPM	603	100 k Ω	
5	R36, R40, R43, R46, R48	Resistor, chip, 1/16 W, 5%	603	470 Ω	
4	R4, R5, R6, R7	Resistor, chip, 1/16 W, 5%	603	1 k Ω <	
2	R41, R47	Resistor, chip, 1/16 W, 1%	603	61.9 k Ω	
1	R49	Resistor, chip, 1.16 W, 1%	603	8.45 k Ω	
1	RT1	Thermistor	0.095 \times 0.150	10 k Ω	
1	SW1	Switch, push button, momentary, N.O. low profile	5 mm \times 5 mm		
2	TB1, TB2	Terminal block, 3 pin, 6 A, 3.5 mm	0.41 \times 0.25		ED1515
2	TB3, TB4	Terminal block, 2 pin, 6 A, 3.5 mm	0.27 \times 0.25		ED1514

Table 3. Bill of Materials (continued)

COUNT	REF DES	DESCRIPTION	SIZE	VALUE	MFG PART NO.
3	TP1, TP4, TP5	Jack, test point, cir		NA	
1	U1	IC, voltage protection for 2, 3, or 4 cell Li-Ion, 2nd protection, x.xx	TSSOP-08		bq29400PW
1	U2	IC, 2, 3, or 4 cell series protection control AFE	TSSOP24		bq29312PW
1	U3	IC, advanced gas gauge	TSSOP38		bq2084DBT
1	-	PCB			

4.3 bq2084/bq29312/bq29401 CIRCUIT MODULE PERFORMANCE SPECIFICATION SUMMARY

This section summarizes the performance specifications of the bq2084/bq29312/bq29401 circuit module.

Table 4. Performance Specification Summary

SPECIFICATION	MIN	TYP	MAX	UNITS
Input Voltage Pack+ to Pack-	6.0		25	V
Charge and Discharge Current			See ⁽¹⁾	A

⁽¹⁾ Maximum currents are determined by the value of the sense resistor used and the short circuit threshold setting of the bq29312. It is important to operate this EVM within the input voltage range of 6 V and 25 V, with a maximum voltage drop across the sense resistor of ± 250 mV (1-W power dissipation).

5 EVM HARDWARE AND SOFTWARE SETUP

This chapter describes how to install the bq2084EVM-001 PC software, and how to connect the different components of the EVM.

5.1 SYSTEM REQUIREMENTS

EV2300-84 software requires Windows 2000 or Windows XP. Drivers for Windows 98SE are provided, but Microsoft no longer supports Windows 98™; and there may be issues in Windows 98™ with USB driver support. The EV2300 USB drivers have been tested for Windows 98SE™, but no assurance is made for problem-free operation with specific system configurations.

5.2 SOFTWARE INSTALLATION

You can find the latest software version in the bq2084 tool folder on power.ti.com. The following steps install the EV2300-84 software:

If files were delivered on floppy disks:

1. Insert disk 1 into a 3-1/2-inch floppy drive.
2. Select the 3-1/2-inch drive using My Computer or File Manager. Execute setup.exe which prompts you to enter a temporary directory to extract all files. Follow the instructions of the extractor program, which prompts you to insert more disks.
3. In the temporary directory you selected, open the archive TI USB DRVRS.zip and extract its contents in a subdirectory/drivers. Choose preserve directory structure option when extracting.
4. Plug the EV2300 into a USB port.
5. Wait until system prompt new hardware found appears. Chose select location manually and use the Browse button to point to subdirectory TIUSBWin2K- XP-1.
6. Answer continue to the warning that drivers are not certified with Microsoft.
7. After installation finishes, another system prompt new hardware found appears. Repeat procedure above, but point to subdirectory TIUSBWin2K-XP-2
8. Answer continue to the warning that drivers are not certified with Microsoft. Installation of drivers is

now finished.

9. In case of Windows 98, point to directory TIUSBWin98.
10. Return to the temporary directory where you extracted files; double-click on the Setup.exe icon to install EV Software.

If files were delivered on a CD, copy all files to a temporary directory and follow the preceding steps 3–10.

1. Open the archive containing the installation package and copy its contents in a temporary directory.
2. Follow the preceding steps 3–10.

5.3 HARDWARE CONNECTION

The bq2084EVM-001 comprises three hardware components: the bq2084/bq29312/bq29401 circuit module, the EV2300 PC interface board, and the PC.

5.3.1 CONNECTING THE BQ2084/BQ29312/BQ29401 CIRCUIT MODULE TO A BATTERY PACK

Figure 9 shows how to connect the bq2084/bq29312/bq29401 circuit module to the cells and system load/charger.

The cells should be connected in the following order.

1. 4-Cell Pack: 1N (BAT–), 4P (BAT+), 1P, 2P, and then 3P. (see section 2.1 for definitions)
2. 3-Cell Pack: 1N (BAT–), 4P (BAT+), 1P, 2P, and then connect 4P and 3P together.
3. 2-Cell Pack: 1N (BAT–), 4P (BAT+), 1P, and then connect 4P, 3P, and 2P together

To start charge or discharge test, connect SYS PRES pin to PACK– pin to set SYS PRES state. To test sleep mode, disconnect SYS PRES pin.

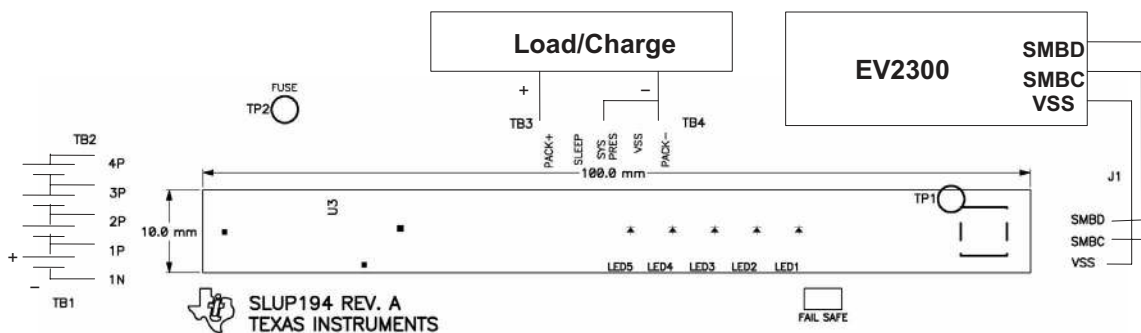

Figure 9. bq2084/bq29312 Circuit Module Connection to Cells and System Load/Charger

5.3.2 PC INTERFACE CONNECTION

The following steps configure the hardware for interface to the PC:

1. Connect the bq2084/bq29312-based smart battery to the EV2300 using wire leads as shown in Table 5.

Table 5. Circuit Module to EV2300 Connections

bq2084/bq29312 BASED BATTERY	EV2300
SMBD	SMBD/HDQ1
SMBC	SMBC/HDQ2
VSS	VSS

2. Connect the PC USB cable to the EV2300 and the PC USB port.
The bq2084EVM-001 is now set up for operation.

6 OPERATION

This chapter details the operation of the bq2084 EVSW software.

6.1 STARTING THE PROGRAM

Run bq2084 EVSW from the Start | Programs | Texas Instruments | bq2084 EVSW menu sequence. The SBS Data screen appears. Data begins to appear as the indicator scans down the screen, as seen in the field *Charging Current* of Figure 10. To disable the scan feature, select |Options |Scan| Off|.

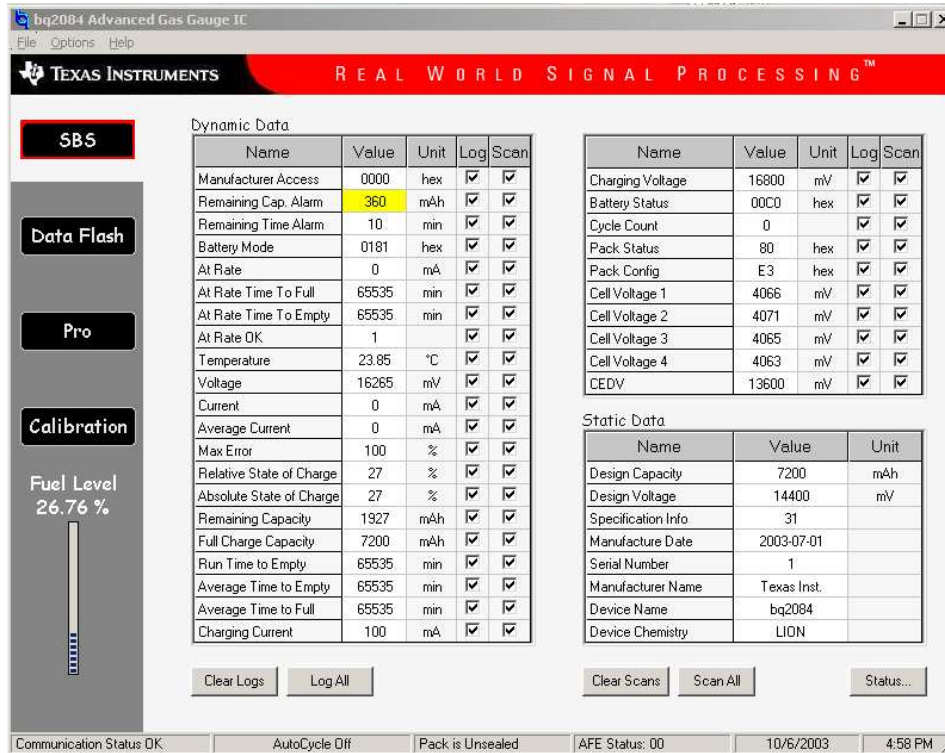

Figure 10. SBS Data Screen

This screen shows the SBS data set along with additional ManufacturersAccess() command information such as individual cell measurements. Static data is shown in a box at the bottom right which, by clicking on the Status... button, changes to show the status bits of the bq2084 and bq29312.

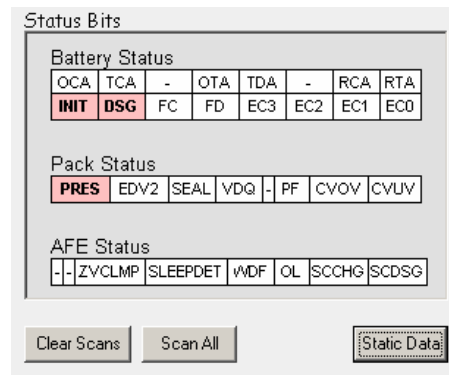

Figure 11. SBS Data Screen - Status Bit Window

SBS Data can be logged for further evaluation by using the File | Start Data Log menu options. Then enter the desired file name and click on [OK]. An example of a data log file is shown in Table 6–1. To stop the data log, follow the same sequence. The logging period can be changed via | Options | Set Logging Options |.

Table 6. Example Log File

```

10/6/2003 17:01
Design Capacity: 7200
Design Voltage: 14400
Specification Info: 31
Mfg Date (yyy-mm-dd): 2003-07-01
Serial Number: 1
Mfr Name: Texas Instruments
Device Name: bq2084
Device Chemistry: LION
  
```

Table 7. Example Log File⁽¹⁾

Sample	Stamp	Elapsed (s)	Mf Access	Rm Cap Aln	Rm Time Air	Batt-Mode	@Rate	@Rate-Ful	@Rate Emp	@Rate OK	Temp	Volt	Current	Avg-Curr
1	5:01:53	1	0	360	10	181	0	65535	65535	1	23.95	16266	0	0
2	5:01:55	2	0	360	10	181	0	65535	65535	1	23.95	16266	0	0
4	5:01:56	4	0	360	10	181	0	65535	65535	1	23.95	16267	0	0
5	5:01:57	5	0	360	10	181	0	65535	65535	1	23.95	16267	0	0
6	5:01:58	6	0	360	10	181	0	65535	65535	1	23.95	16267	0	0
7	5:01:59	7	0	360	10	181	0	65535	65535	1	23.95	16266	0	0
8	5:02:00	8	0	360	10	181	0	65535	65535	1	23.95	16266	0	0
9	5:02:01	9	0	360	10	181	0	65535	65535	1	23.95	16266	0	0
10	5:02:02	10	0	360	10	181	0	65535	65535	1	23.95	16266	0	0
11	5:02:03	11	0	360	10	181	0	65535	65535	1	23.95	16266	0	0
12	5:02:04	12	0	360	10	181	0	65535	65535	1	23.95	16266	0	0

⁽¹⁾ This is a reduced version of the log file; in addition to the data shown here, Max Error, RSOC, ASOC, RemCap, FCC, RT-Empty, AvTm2Emp, AvTm2Ful, ChgCurr, ChgVlt, Batstat, CyclCnt, PackStat, PackConf, Cell_V_1, Cell_V_2, Cell_V_3, Cell_V_4, CEDV, AFE Sts are also logged.

6.2 SETTING PROGRAMMABLE bq2084 and bq29312 OPTIONS

The bq2084 data flash comes configured per the default settings detailed in the bq2084 data sheet. Ensure that the settings are correctly changed to match the pack and application for the bq2084/bq29312 solution being evaluated.

IMPORTANT: The correct setting of these options is essential to get the best performance.

The settings can be configured using the Data Flash screen.

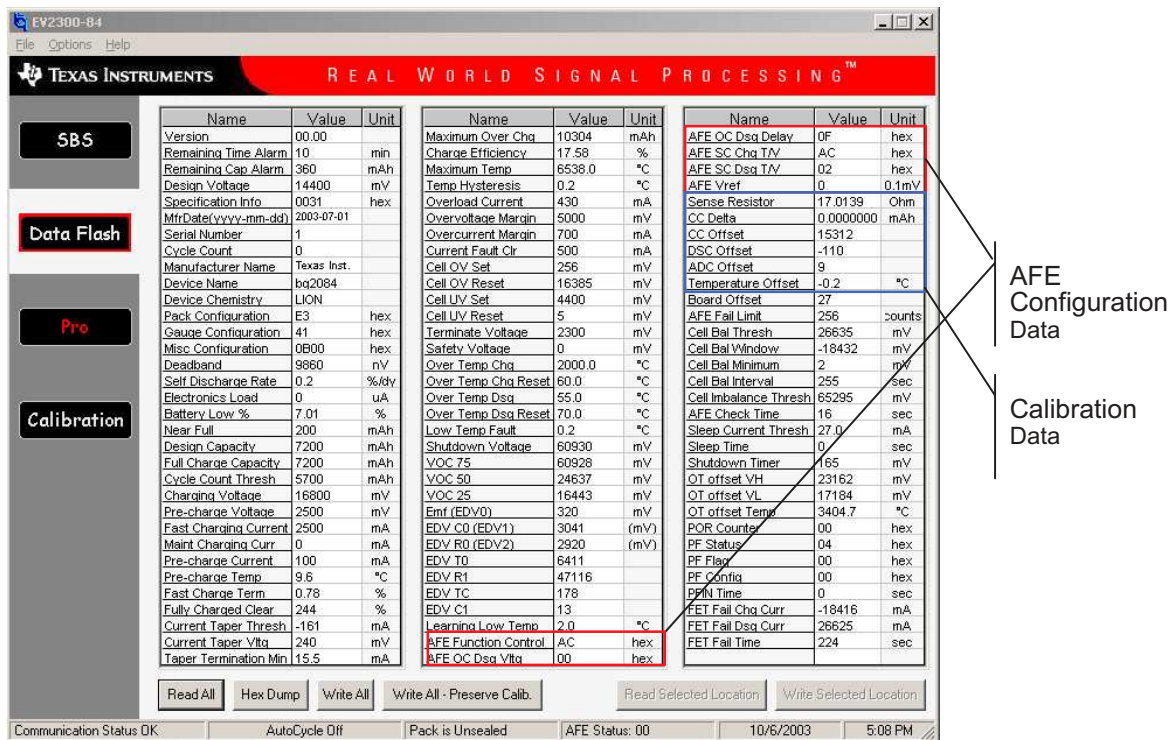

Figure 12. Data Flash Screen, AFE Configuration, and Module Calibration Locations

To read all the data from the bq2084 data flash, click on the | Read All | button. To only read a selected location, click on the desired location and the | Read Selected Location | button is activated. When this button is clicked, the data is read and the screen updated.

The same procedure can be followed for writing all the data flash or just a specific location.

The data flash configuration can be saved to a file by selecting | File | Save gas gauge constants |, and entering a file name. A data flash file can also be retrieved in this way and written to the bq2084 using the | Write All | button.

If the calibration data already in the bq2084 is required to be preserved, use the | Write All – Preserve Calibration | button.

The configuration information of the bq29312 and module calibration data is also held in the bq2084 data flash as highlighted in [Figure 13](#).

6.3 CALIBRATION OF A bq2084/bq29312/bq29401-BASED MODULE USING THE EV2300-84 SOFTWARE

Part of the calibration data is a board offset parameter. The EV2300-84 software allows the board offset to be measured. An average of several modules should be taken, and then this value entered in all like modules.

The calibration screen offers a simple-to-use interface for this procedure.

Follow the on-screen instructions as shown in [Figure 13](#). Click |Start| to begin the test, and additional instructions appear for that particular calibration procedure until it is complete.

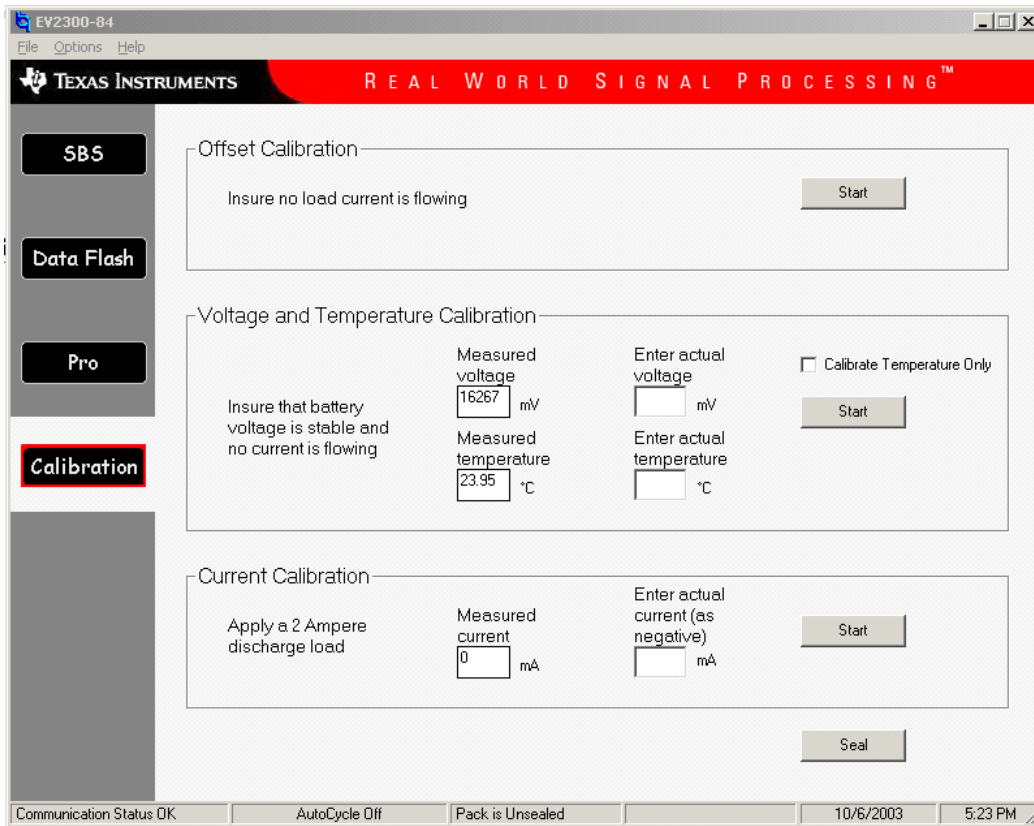

Figure 13. Calibration Screen

6.4 DIRECT ACCESS COMMUNICATION

The bq2084 allows access to the various internal registers through the Pro Screen. Here, individual byte or block reads and block writes can be performed.

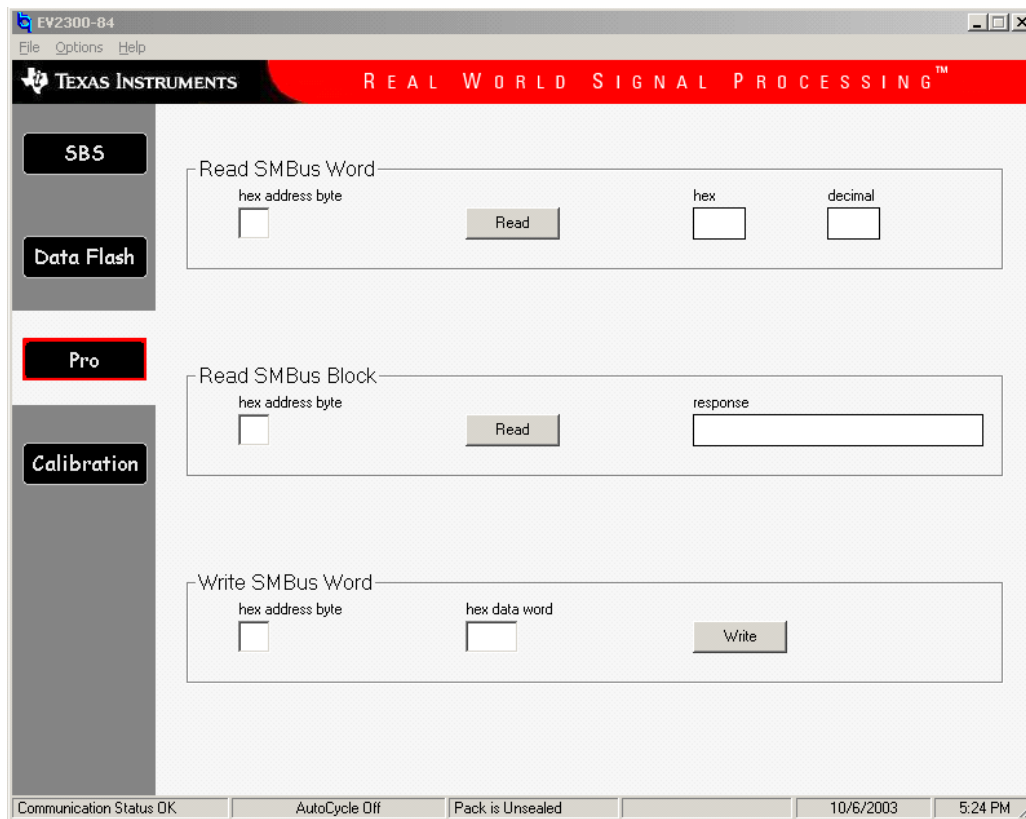

Figure 14. Pro Screen

EVALUATION BOARD/KIT/MODULE (EVM) ADDITIONAL TERMS

Texas Instruments (TI) provides the enclosed Evaluation Board/Kit/Module (EVM) under the following conditions:

The user assumes all responsibility and liability for proper and safe handling of the goods. Further, the user indemnifies TI from all claims arising from the handling or use of the goods.

Should this evaluation board/kit not meet the specifications indicated in the User's Guide, the board/kit may be returned within 30 days from the date of delivery for a full refund. THE FOREGOING LIMITED WARRANTY IS THE EXCLUSIVE WARRANTY MADE BY SELLER TO BUYER AND IS IN LIEU OF ALL OTHER WARRANTIES, EXPRESSED, IMPLIED, OR STATUTORY, INCLUDING ANY WARRANTY OF MERCHANTABILITY OR FITNESS FOR ANY PARTICULAR PURPOSE. EXCEPT TO THE EXTENT OF THE INDEMNITY SET FORTH ABOVE, NEITHER PARTY SHALL BE LIABLE TO THE OTHER FOR ANY INDIRECT, SPECIAL, INCIDENTAL, OR CONSEQUENTIAL DAMAGES.

Please read the User's Guide and, specifically, the Warnings and Restrictions notice in the User's Guide prior to handling the product. This notice contains important safety information about temperatures and voltages. For additional information on TI's environmental and/or safety programs, please visit www.ti.com/esh or contact TI.

No license is granted under any patent right or other intellectual property right of TI covering or relating to any machine, process, or combination in which such TI products or services might be or are used. TI currently deals with a variety of customers for products, and therefore our arrangement with the user is not exclusive. TI assumes no liability for applications assistance, customer product design, software performance, or infringement of patents or services described herein.

REGULATORY COMPLIANCE INFORMATION

As noted in the EVM User's Guide and/or EVM itself, this EVM and/or accompanying hardware may or may not be subject to the Federal Communications Commission (FCC) and Industry Canada (IC) rules.

For EVMs **not** subject to the above rules, this evaluation board/kit/module is intended for use for ENGINEERING DEVELOPMENT, DEMONSTRATION OR EVALUATION PURPOSES ONLY and is not considered by TI to be a finished end product fit for general consumer use. It generates, uses, and can radiate radio frequency energy and has not been tested for compliance with the limits of computing devices pursuant to part 15 of FCC or ICES-003 rules, which are designed to provide reasonable protection against radio frequency interference. Operation of the equipment may cause interference with radio communications, in which case the user at his own expense will be required to take whatever measures may be required to correct this interference.

General Statement for EVMs including a radio

User Power/Frequency Use Obligations: This radio is intended for development/professional use only in legally allocated frequency and power limits. Any use of radio frequencies and/or power availability of this EVM and its development application(s) must comply with local laws governing radio spectrum allocation and power limits for this evaluation module. It is the user's sole responsibility to only operate this radio in legally acceptable frequency space and within legally mandated power limitations. Any exceptions to this are strictly prohibited and unauthorized by Texas Instruments unless user has obtained appropriate experimental/development licenses from local regulatory authorities, which is responsibility of user including its acceptable authorization.

For EVMs annotated as FCC – FEDERAL COMMUNICATIONS COMMISSION Part 15 Compliant

Caution

This device complies with part 15 of the FCC Rules. Operation is subject to the following two conditions: (1) This device may not cause harmful interference, and (2) this device must accept any interference received, including interference that may cause undesired operation.

Changes or modifications not expressly approved by the party responsible for compliance could void the user's authority to operate the equipment.

FCC Interference Statement for Class A EVM devices

This equipment has been tested and found to comply with the limits for a Class A digital device, pursuant to part 15 of the FCC Rules. These limits are designed to provide reasonable protection against harmful interference when the equipment is operated in a commercial environment. This equipment generates, uses, and can radiate radio frequency energy and, if not installed and used in accordance with the instruction manual, may cause harmful interference to radio communications. Operation of this equipment in a residential area is likely to cause harmful interference in which case the user will be required to correct the interference at his own expense.

FCC Interference Statement for Class B EVM devices

This equipment has been tested and found to comply with the limits for a Class B digital device, pursuant to part 15 of the FCC Rules. These limits are designed to provide reasonable protection against harmful interference in a residential installation. This equipment generates, uses and can radiate radio frequency energy and, if not installed and used in accordance with the instructions, may cause harmful interference to radio communications. However, there is no guarantee that interference will not occur in a particular installation. If this equipment does cause harmful interference to radio or television reception, which can be determined by turning the equipment off and on, the user is encouraged to try to correct the interference by one or more of the following measures:

- Reorient or relocate the receiving antenna.
- Increase the separation between the equipment and receiver.
- Connect the equipment into an outlet on a circuit different from that to which the receiver is connected.
- Consult the dealer or an experienced radio/TV technician for help.

For EVMs annotated as IC – INDUSTRY CANADA Compliant

This Class A or B digital apparatus complies with Canadian ICES-003.

Changes or modifications not expressly approved by the party responsible for compliance could void the user's authority to operate the equipment.

Concerning EVMs including radio transmitters

This device complies with Industry Canada licence-exempt RSS standard(s). Operation is subject to the following two conditions: (1) this device may not cause interference, and (2) this device must accept any interference, including interference that may cause undesired operation of the device.

Concerning EVMs including detachable antennas

Under Industry Canada regulations, this radio transmitter may only operate using an antenna of a type and maximum (or lesser) gain approved for the transmitter by Industry Canada. To reduce potential radio interference to other users, the antenna type and its gain should be so chosen that the equivalent isotropically radiated power (e.i.r.p.) is not more than that necessary for successful communication.

This radio transmitter has been approved by Industry Canada to operate with the antenna types listed in the user guide with the maximum permissible gain and required antenna impedance for each antenna type indicated. Antenna types not included in this list, having a gain greater than the maximum gain indicated for that type, are strictly prohibited for use with this device.

Cet appareil numérique de la classe A ou B est conforme à la norme NMB-003 du Canada.

Les changements ou les modifications pas expressément approuvés par la partie responsable de la conformité ont pu vider l'autorité de l'utilisateur pour actionner l'équipement.

Concernant les EVMs avec appareils radio

Le présent appareil est conforme aux CNR d'Industrie Canada applicables aux appareils radio exempts de licence. L'exploitation est autorisée aux deux conditions suivantes : (1) l'appareil ne doit pas produire de brouillage, et (2) l'utilisateur de l'appareil doit accepter tout brouillage radioélectrique subi, même si le brouillage est susceptible d'en compromettre le fonctionnement.

Concernant les EVMs avec antennes détachables

Conformément à la réglementation d'Industrie Canada, le présent émetteur radio peut fonctionner avec une antenne d'un type et d'un gain maximal (ou inférieur) approuvé pour l'émetteur par Industrie Canada. Dans le but de réduire les risques de brouillage radioélectrique à l'intention des autres utilisateurs, il faut choisir le type d'antenne et son gain de sorte que la puissance isotrope rayonnée équivalente (p.i.r.e.) ne dépasse pas l'intensité nécessaire à l'établissement d'une communication satisfaisante.

Le présent émetteur radio a été approuvé par Industrie Canada pour fonctionner avec les types d'antenne énumérés dans le manuel d'usage et ayant un gain admissible maximal et l'impédance requise pour chaque type d'antenne. Les types d'antenne non inclus dans cette liste, ou dont le gain est supérieur au gain maximal indiqué, sont strictement interdits pour l'exploitation de l'émetteur.

【Important Notice for Users of EVMs for RF Products in Japan】

This development kit is NOT certified as Confirming to Technical Regulations of Radio Law of Japan

If you use this product in Japan, you are required by Radio Law of Japan to follow the instructions below with respect to this product:

1. Use this product in a shielded room or any other test facility as defined in the notification #173 issued by Ministry of Internal Affairs and Communications on March 28, 2006, based on Sub-section 1.1 of Article 6 of the Ministry's Rule for Enforcement of Radio Law of Japan,
2. Use this product only after you obtained the license of Test Radio Station as provided in Radio Law of Japan with respect to this product, or
3. Use of this product only after you obtained the Technical Regulations Conformity Certification as provided in Radio Law of Japan with respect to this product. Also, please do not transfer this product, unless you give the same notice above to the transferee. Please note that if you could not follow the instructions above, you will be subject to penalties of Radio Law of Japan.

Texas Instruments Japan Limited
(address) 24-1, Nishi-Shinjuku 6 chome, Shinjuku-ku, Tokyo, Japan

<http://www.tij.co.jp>

【無線電波を送信する製品の開発キットをお使いになる際の注意事項】

本開発キットは技術基準適合証明を受けておりません。

本製品のご使用に際しては、電波法遵守のため、以下のいずれかの措置を取っていただく必要がありますのでご注意ください。

1. 電波法施行規則第6条第1項第1号に基づく平成18年3月28日総務省告示第173号で定められた電波暗室等の試験設備でご使用いただく。
2. 実験局の免許を取得後ご使用いただく。
3. 技術基準適合証明を取得後ご使用いただく。

なお、本製品は、上記の「ご使用にあたっての注意」を譲渡先、移転先に通知しない限り、譲渡、移転できないものとします。

上記を遵守頂けない場合は、電波法の罰則が適用される可能性があることをご留意ください。

日本テキサス・インスツルメンツ株式会社
東京都新宿区西新宿 6 丁目 2 4 番 1 号
西新宿三井ビル

<http://www.tij.co.jp>

EVALUATION BOARD/KIT/MODULE (EVM) WARNINGS, RESTRICTIONS AND DISCLAIMERS

For Feasibility Evaluation Only, in Laboratory/Development Environments. Unless otherwise indicated, this EVM is not a finished electrical equipment and not intended for consumer use. It is intended solely for use for preliminary feasibility evaluation in laboratory/development environments by technically qualified electronics experts who are familiar with the dangers and application risks associated with handling electrical mechanical components, systems and subsystems. It should not be used as all or part of a finished end product.

Your Sole Responsibility and Risk. You acknowledge, represent and agree that:

1. You have unique knowledge concerning Federal, State and local regulatory requirements (including but not limited to Food and Drug Administration regulations, if applicable) which relate to your products and which relate to your use (and/or that of your employees, affiliates, contractors or designees) of the EVM for evaluation, testing and other purposes.
2. You have full and exclusive responsibility to assure the safety and compliance of your products with all such laws and other applicable regulatory requirements, and also to assure the safety of any activities to be conducted by you and/or your employees, affiliates, contractors or designees, using the EVM. Further, you are responsible to assure that any interfaces (electronic and/or mechanical) between the EVM and any human body are designed with suitable isolation and means to safely limit accessible leakage currents to minimize the risk of electrical shock hazard.
3. Since the EVM is not a completed product, it may not meet all applicable regulatory and safety compliance standards (such as UL, CSA, VDE, CE, RoHS and WEEE) which may normally be associated with similar items. You assume full responsibility to determine and/or assure compliance with any such standards and related certifications as may be applicable. You will employ reasonable safeguards to ensure that your use of the EVM will not result in any property damage, injury or death, even if the EVM should fail to perform as described or expected.
4. You will take care of proper disposal and recycling of the EVM's electronic components and packing materials.

Certain Instructions. It is important to operate this EVM within TI's recommended specifications and environmental considerations per the user guidelines. Exceeding the specified EVM ratings (including but not limited to input and output voltage, current, power, and environmental ranges) may cause property damage, personal injury or death. If there are questions concerning these ratings please contact a TI field representative prior to connecting interface electronics including input power and intended loads. Any loads applied outside of the specified output range may result in unintended and/or inaccurate operation and/or possible permanent damage to the EVM and/or interface electronics. Please consult the EVM User's Guide prior to connecting any load to the EVM output. If there is uncertainty as to the load specification, please contact a TI field representative. During normal operation, some circuit components may have case temperatures greater than 60°C as long as the input and output are maintained at a normal ambient operating temperature. These components include but are not limited to linear regulators, switching transistors, pass transistors, and current sense resistors which can be identified using the EVM schematic located in the EVM User's Guide. When placing measurement probes near these devices during normal operation, please be aware that these devices may be very warm to the touch. As with all electronic evaluation tools, only qualified personnel knowledgeable in electronic measurement and diagnostics normally found in development environments should use these EVMs.

Agreement to Defend, Indemnify and Hold Harmless. You agree to defend, indemnify and hold TI, its licensors and their representatives harmless from and against any and all claims, damages, losses, expenses, costs and liabilities (collectively, "Claims") arising out of or in connection with any use of the EVM that is not in accordance with the terms of the agreement. This obligation shall apply whether Claims arise under law of tort or contract or any other legal theory, and even if the EVM fails to perform as described or expected.

Safety-Critical or Life-Critical Applications. If you intend to evaluate the components for possible use in safety critical applications (such as life support) where a failure of the TI product would reasonably be expected to cause severe personal injury or death, such as devices which are classified as FDA Class III or similar classification, then you must specifically notify TI of such intent and enter into a separate Assurance and Indemnity Agreement.

Mailing Address: Texas Instruments, Post Office Box 655303, Dallas, Texas 75265
Copyright © 2013, Texas Instruments Incorporated

IMPORTANT NOTICE

Texas Instruments Incorporated and its subsidiaries (TI) reserve the right to make corrections, enhancements, improvements and other changes to its semiconductor products and services per JESD46, latest issue, and to discontinue any product or service per JESD48, latest issue. Buyers should obtain the latest relevant information before placing orders and should verify that such information is current and complete. All semiconductor products (also referred to herein as "components") are sold subject to TI's terms and conditions of sale supplied at the time of order acknowledgment.

TI warrants performance of its components to the specifications applicable at the time of sale, in accordance with the warranty in TI's terms and conditions of sale of semiconductor products. Testing and other quality control techniques are used to the extent TI deems necessary to support this warranty. Except where mandated by applicable law, testing of all parameters of each component is not necessarily performed.

TI assumes no liability for applications assistance or the design of Buyers' products. Buyers are responsible for their products and applications using TI components. To minimize the risks associated with Buyers' products and applications, Buyers should provide adequate design and operating safeguards.

TI does not warrant or represent that any license, either express or implied, is granted under any patent right, copyright, mask work right, or other intellectual property right relating to any combination, machine, or process in which TI components or services are used. Information published by TI regarding third-party products or services does not constitute a license to use such products or services or a warranty or endorsement thereof. Use of such information may require a license from a third party under the patents or other intellectual property of the third party, or a license from TI under the patents or other intellectual property of TI.

Reproduction of significant portions of TI information in TI data books or data sheets is permissible only if reproduction is without alteration and is accompanied by all associated warranties, conditions, limitations, and notices. TI is not responsible or liable for such altered documentation. Information of third parties may be subject to additional restrictions.

Resale of TI components or services with statements different from or beyond the parameters stated by TI for that component or service voids all express and any implied warranties for the associated TI component or service and is an unfair and deceptive business practice. TI is not responsible or liable for any such statements.

Buyer acknowledges and agrees that it is solely responsible for compliance with all legal, regulatory and safety-related requirements concerning its products, and any use of TI components in its applications, notwithstanding any applications-related information or support that may be provided by TI. Buyer represents and agrees that it has all the necessary expertise to create and implement safeguards which anticipate dangerous consequences of failures, monitor failures and their consequences, lessen the likelihood of failures that might cause harm and take appropriate remedial actions. Buyer will fully indemnify TI and its representatives against any damages arising out of the use of any TI components in safety-critical applications.

In some cases, TI components may be promoted specifically to facilitate safety-related applications. With such components, TI's goal is to help enable customers to design and create their own end-product solutions that meet applicable functional safety standards and requirements. Nonetheless, such components are subject to these terms.

No TI components are authorized for use in FDA Class III (or similar life-critical medical equipment) unless authorized officers of the parties have executed a special agreement specifically governing such use.

Only those TI components which TI has specifically designated as military grade or "enhanced plastic" are designed and intended for use in military/aerospace applications or environments. Buyer acknowledges and agrees that any military or aerospace use of TI components which have **not** been so designated is solely at the Buyer's risk, and that Buyer is solely responsible for compliance with all legal and regulatory requirements in connection with such use.

TI has specifically designated certain components as meeting ISO/TS16949 requirements, mainly for automotive use. In any case of use of non-designated products, TI will not be responsible for any failure to meet ISO/TS16949.

Products

Audio	www.ti.com/audio
Amplifiers	amplifier.ti.com
Data Converters	dataconverter.ti.com
DLP® Products	www.dlp.com
DSP	dsp.ti.com
Clocks and Timers	www.ti.com/clocks
Interface	interface.ti.com
Logic	logic.ti.com
Power Mgmt	power.ti.com
Microcontrollers	microcontroller.ti.com
RFID	www.ti-rfid.com
OMAP Applications Processors	www.ti.com/omap
Wireless Connectivity	www.ti.com/wirelessconnectivity

Applications

Automotive and Transportation	www.ti.com/automotive
Communications and Telecom	www.ti.com/communications
Computers and Peripherals	www.ti.com/computers
Consumer Electronics	www.ti.com/consumer-apps
Energy and Lighting	www.ti.com/energy
Industrial	www.ti.com/industrial
Medical	www.ti.com/medical
Security	www.ti.com/security
Space, Avionics and Defense	www.ti.com/space-avionics-defense
Video and Imaging	www.ti.com/video

TI E2E Community

e2e.ti.com