

MATERIALS & SPECIFICATIONS

INSULATORS

THERMOPLASTIC PER ASTM D5138

CONTACT MATERIAL

PINS - BERYLLIUM
COPPER PER ASTM B194,
ALLOY C17200
SOCKET - COPPER ALLOY
PER MIL-DTL-32139

CONTACT FINISH

GOLD PLATE PER ASTM B488, TYPE II (HARD GOLD), CODE C, CLASS 1.27

TERMINATION FINISH

SOLDER COATED WITH
SN63 PER J-STD-006 OR
SN60 PER AMS-P-81728

CURRENT RATING

1 AMP PER MIL-DTL-32139

CONTACT RESISTANCE

71 MILLIOHM MAX (71mV DROP MAX) @ 1.0 AMPS PER MIL-DTL-32139

PERFORMANCE

PRODUCT FAMILY TESTED TO AND PASSED THE PERFORMANCE SPECIFICATIONS OF TABLE VIII OF MIL-DTL-32139



ACTUAL SIZE

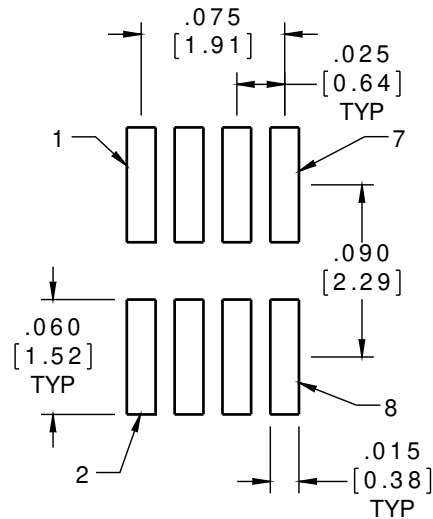
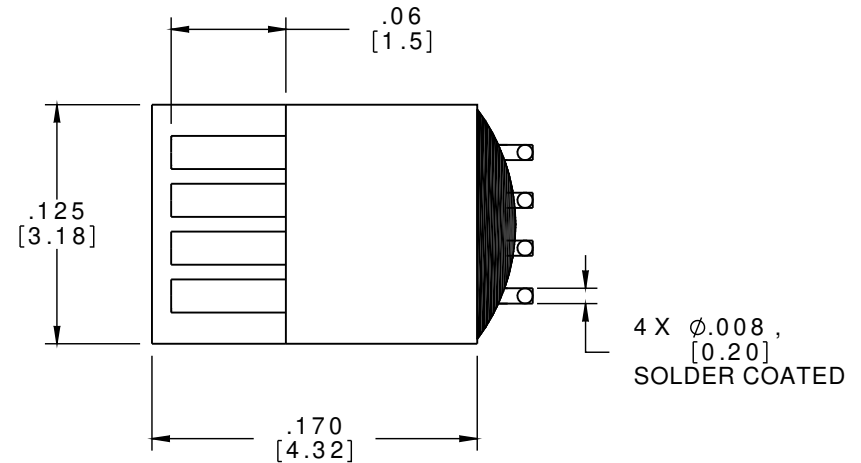
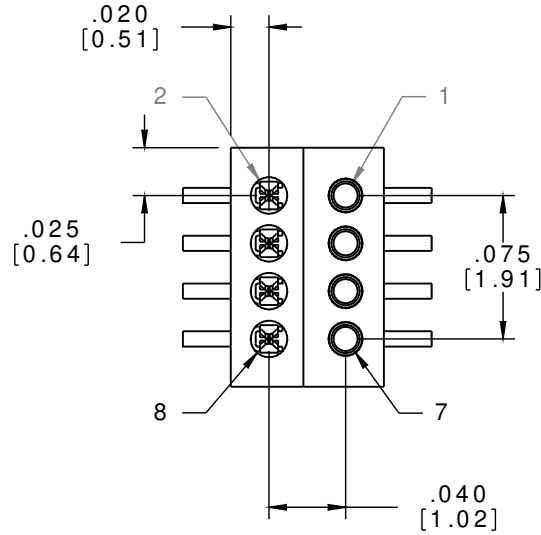

SUGGESTED PAD LAYOUT

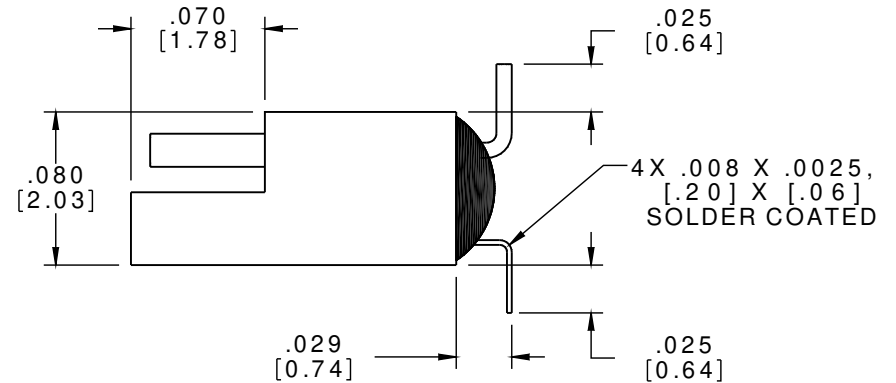

NOTE:

DIMENSIONS IN [] ARE IN MILLIMETERS UNLESS OTHERWISE NOTED AND ARE FOR REFERENCE ONLY

PZN SLDW	THIRD ANGLE
	-TOLERANCES- UNLESS OTHERWISE NOTED
	DIMENSIONS IN INCHES
	2 PL DEC ± .01 3 PL DEC ± .005 4 PL DEC ± .0005 ANGLES ± 1°

THIS DRAWING CONTAINS CONFIDENTIAL AND PROPRIETARY INFORMATION WHICH IS THE PROPERTY OF OMNETICS CONNECTOR CORP. THIS DOCUMENT MAY NOT, IN WHOLE OR IN PART, BE DUPLICATED, OR DISCLOSED FOR ANY PURPOSE, WITHOUT WRITTEN PERMISSION FROM OMNETICS CONNECTOR CORP.	
DFTM. NJS	DATE 08-24-09
CHK'D.	DATE
APP'D.	DATE

TITLE:
(8) CONTACT POLARIZED
MALE/FEMALE
NANO CONNECTOR

OMNETICS
CONNECTOR CORPORATION
7260 COMMERCE CIRCLE EAST
MINNEAPOLIS, MN 55432
WWW.OMNETICS.COM

CAGE CODE 61873
DWG NO. A79612-001
SHEET 1 OF 1
SCALE: 10:1
REV D