



# AFE2000

Active Front End Unit

#### Delta Electronics, Inc.

Taoyuan1  
31-1, Xingbang Road, Guishan Industrial Zone,  
Taoyuan County 33370, Taiwan, R.O.C.  
TEL: 886-3-362-6301 / FAX: 886-3-362-7267

#### Delta Electronics (Jiang Su) Ltd.

Wujiang Plant3  
1688 Jiangxing East Road,  
Wujiang Economy Development Zone,  
Wujiang City, Jiang Su Province,  
People's Republic of China (Post code: 215200)  
TEL: 86-512-6340-3008 / FAX: 86-512-6340-7290

#### Delta Greentech (China) Co., Ltd.

238 Min-Xia Road, Cao-Lu Industry Zone, Pudong, Shanghai,  
People's Republic of China  
Post code: 201209  
TEL: 021-58635678 / FAX: 021-58630003

#### Delta Electronics (Japan), Inc.

Tokyo Office  
Delta Shibadaimon Building, 2-1-14  
Shibadaimon, Minato-Ku, Tokyo, 105-0012,  
Japan  
TEL: 81-3-5733-1111 / FAX: 81-3-5733-1211

#### Delta Electronics (Korea) Inc.

234-9, Duck Soo Building 7F, Nonhyun-Dong,  
Kangnam-Gu, Seoul, Korea 135-010  
TEL: 82-2-515-5305 / FAX: 82-2-515-5302

#### Delta Electronics (Singapore) Pte. Ltd.

8 Kaki Bukit Road 2, #04-18 Ruby Warehouse Complex,  
Singapore 417841  
TEL: 65-6747-5155 / FAX: 65-6744-9228

#### Delta Electronics (India) Pvt. Ltd.

Plot No. 43, Sector - 35, HSIIDC,  
Gurgaon 122001, Haryana, India  
TEL: 91-124-416-9040 / FAX: 91-124-403-6045

#### America

##### Delta Products Corporation (USA)

Raleigh Office  
P.O. Box 12173, 5101 Davis Drive,  
Research Triangle Park, NC 27709, U.S.A.  
TEL: 1-919-767-3813 / FAX: 1-919-767-3969

#### Delta Greentech (Brasil) S/A

Sao Paulo Office  
Rua Itapeva, Nº 26, 3º andar, Bela vista  
ZIP: 01332-000 - São Paulo - SP - Brasil  
TEL: 55-11-3568-3875 / FAX: 55-11-3568-3865

#### Europe

##### Deltronics (The Netherlands) B.V.

Eindhoven Office  
De Witbott 15, 5652 AG Eindhoven, The Netherlands  
TEL: 31-40-2592850 / FAX: 31-40-2592851

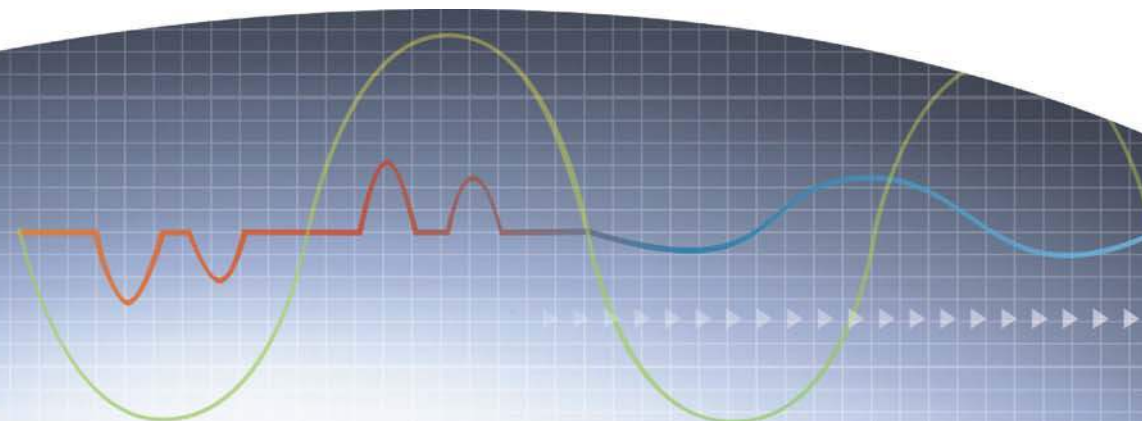

AFE2000

**Features**

- Replaces traditional brake resistor to reduce heat energy.
- Clear energy savings: more than 95% of the energy is regenerated and supplied back to the mains.
- Full-load operation: input-side current THD lower than 4% and power factor up to 99%.
- AC motor drives with AFE2000: supports 4-quadrant operation with variable frequencies and adjustable system.
- Constant DC bus voltage: unaffected by mains voltage fluctuations.

**Applications**

- Large-inertia loads, such as centrifuge equipment, dewatering machines and roving machines.
- 4-quadrant loads including elevators, cranes and pumpjacks (oil extraction machines)
- Quick braking, such as machine tools, bag making machines, auto storage and retrieval systems, and lathes
- Long-term energy feedback, such as wind power, water power, steel printing and paper making machinery (winding equipment).
- Improves power quality for industries such as semiconductor and panel industries

► Crane and Unloading Applications: the AFE2000 replaces the traditional brake resistor to convert the excess heat of motor into reusable energy.

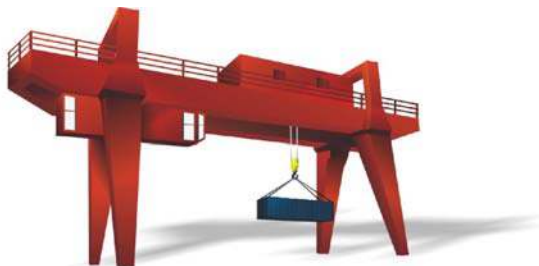

**Four-quadrant operations:**

Elevators, Winches and Crane Applications: four possible speed and torque bundles including speed (+/-) and torque (+/-). The excess heat is converted to reusable energy and supplied back to the mains.

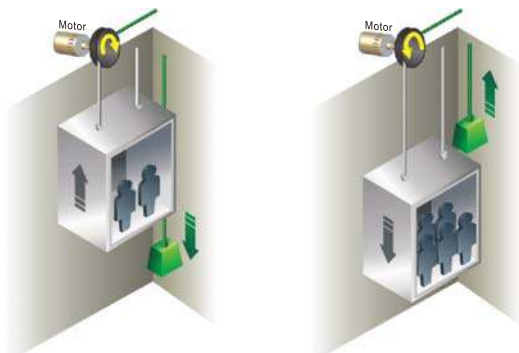

**Replace traditional brake resistors with the AFE2000 to convert regenerative energy (excess heat) into reusable electricity.**

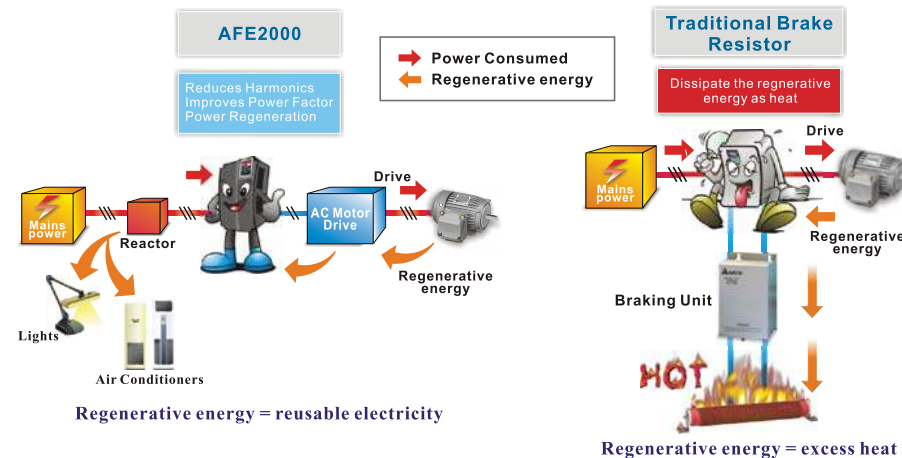

**Improves power factor and decreases harmonic distortion.**

► THD <= 5%, power factor > 99%

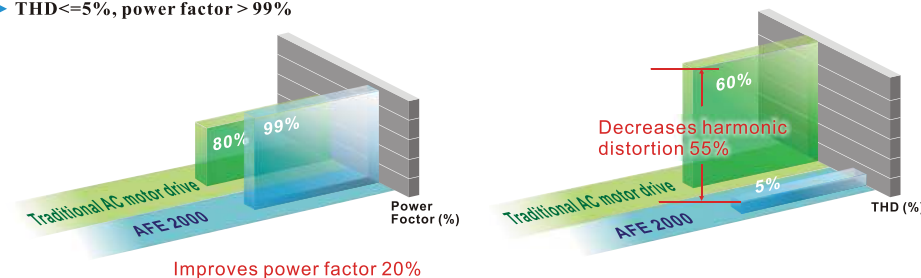

► Improve power factor, lower harmonic distortion, and decrease energy consumption to reduce energy costs and protect the environment.

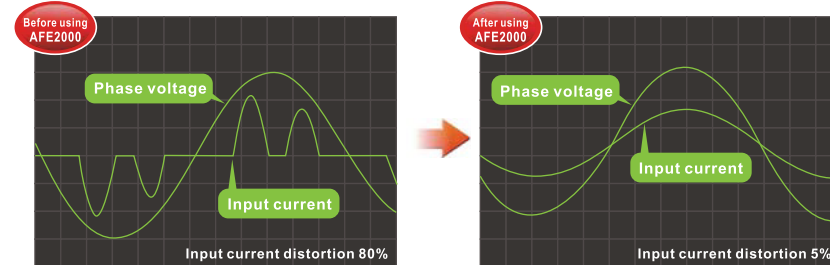

► The AFE2000 is your best choice for the following international standards:

- IEEE519-1992
- IEC/EN61000-3-12
- IEC/EN61000-3-4
- IEC/EN61000-3-2



AFE2000

Multiple solutions

The AFE2000 provides multiple solutions for regenerative energy, offering better power quality while reducing total electricity costs. It achieves Delta's mission "to provide innovative, clean and efficient energy solutions for a better tomorrow".

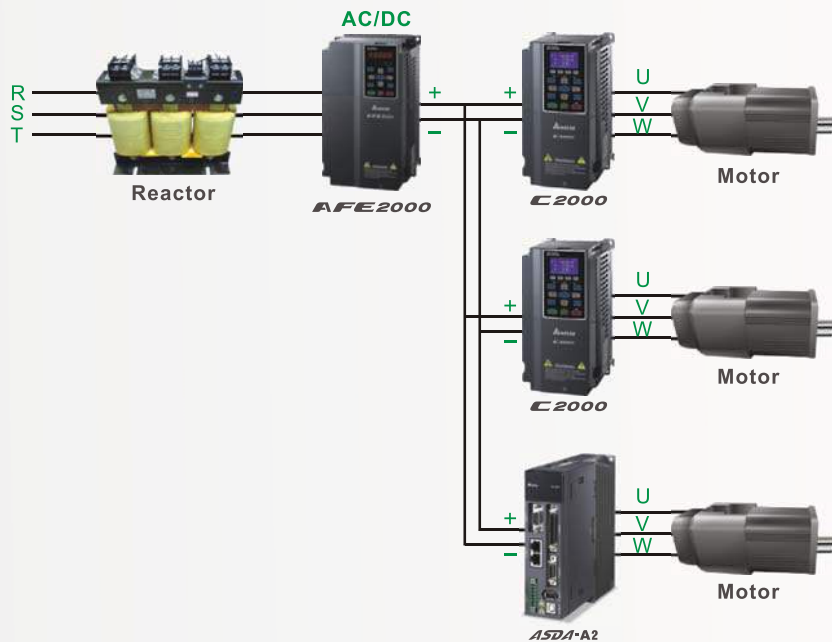

This figure is for demonstration purposes only, please refer to standard wiring diagrams for wiring details.

High-speed Fieldbus

- Provides various communication network cards and fieldbus cards
- Built-in RS-485 modbus protocol
- CANopen (DS301)
- DeviceNet
- Advanced network functions
- PROFINET
- MODBUS TCP
- EtherNet/IP

Specifications

230V	Model AFE-__A23A	075	150	220	370
Applicable power (kW)		7.5	15	22	37
Rated input voltage (V)		170~250Vac			
Rated input current (A)		35	70	95	150
Voltage control		300~370Vdc			
Overload capacity		150% 60Sec			
Frequency tolerance		±5%			
Power factor at input side		0.95 to above 0.99			
Harmonic (%)		Less than 5% (at rated current)			
Enclosure type		IP20/NEMA1			
Cooling method		Fan cooling			
Installation environment	For indoors and altitudes of 0~1000m (3280.60 feet), keep away from direct sunlight, corrosive gases, liquids and dust. For altitudes above 1000m (3280.60 feet), please decrease 3% of rated current for every 500m (1640.40 feet) increase. The maximum altitude is 2500m (8202.00 ft)				
Ambient temperature		-10°C~+50°C			
Storage/transportation temperature		-25~+65°C			
Ambient humidity		Lower than 90%RH (non-condensing)			
Vibration		5.9m/ S <sup>2</sup> (0.6G) less than 10~55Hz (JIS C0040)			

460V	Model AFE-__A43A	075	150	220	370	450	750
Applicable power (kW)		7.5	15	22	37	45	75
Rated input voltage (V)		325~500Vac					
Rated input current (A)		20	35	50	75	95	160
Voltage control		600~740Vdc					
Overload capacity		150% 60Sec					
Frequency tolerance		±5%					
Power factor at input side		0.95 to above 0.99					
Harmonic (%)		Less than 5% (at rated current)					
Enclosure type		IP20/NEMA1					
Cooling method		Fan cooling					
Installation environment	For indoors and altitudes of 0~1000m (3280.60 feet), keep away from direct sunlight, corrosive gases, liquids and dust. For altitudes above 1000m (3280.60 feet), please decrease 3% of rated current for every 500m (1640.40 feet) increase. The maximum altitude is 2500m (8202.00 ft)						
Ambient temperature		-10°C~+50°C					
Storage/transportation temperature		-25~+65°C					
Ambient humidity		Lower than 90%RH (non-condensing)					
Vibration		5.9m/ S <sup>2</sup> (0.6G) less than 10~55Hz (JIS C0040)					

AFE2000

Standard Wiring

One-to-One Installation (One AFE unit + One AC motor drive)

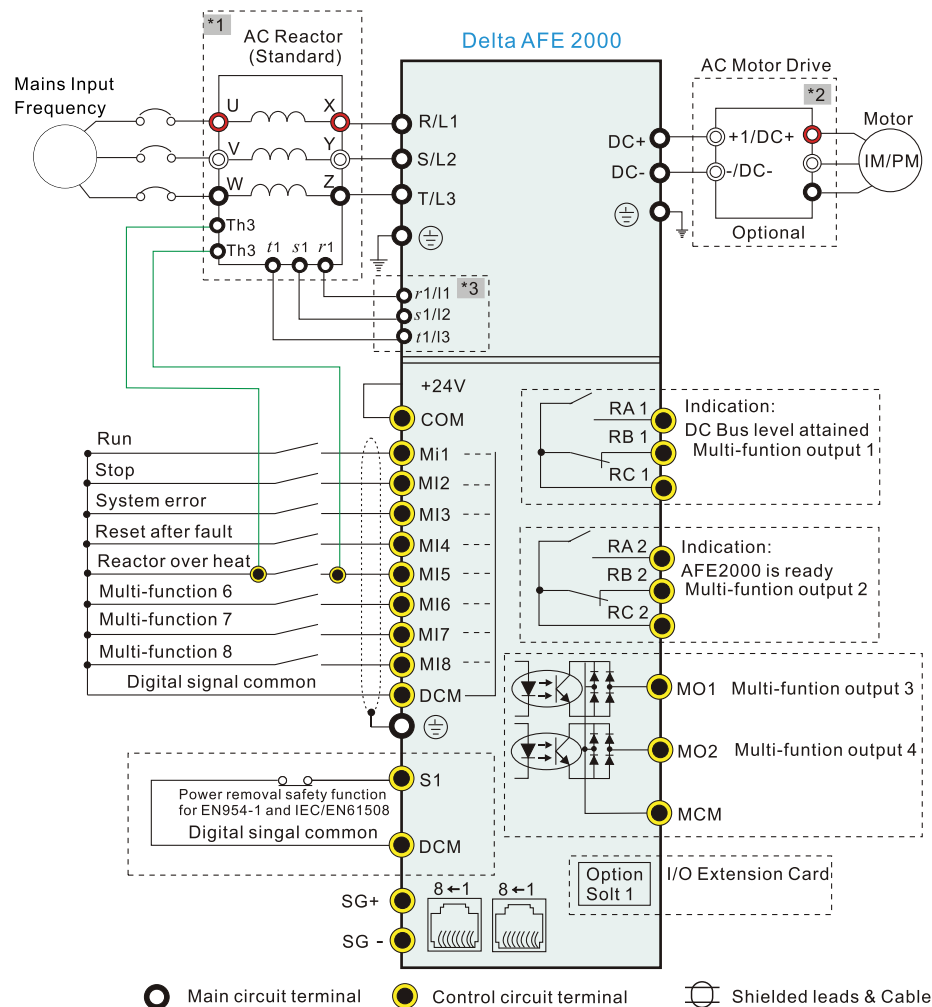

\*1 The Delta AC reactor (optional accessory) comes with a thermal protection function. When the reactor's temperature exceeds 120°C, the TH3 terminal will come ON and the AFE 2000 will receive a signal from the MI terminal to issue a warning message.

\*2 For one-to-many installation, installing a fuse on the AC motor drive's input side is recommended. Please select a compatible fuse for your AC motor drive using the equation: Fuse specification = AC rated input current / 0.78 x 1.5

\*3 If the AC reactor installed on the system is not Delta's AC reactor, please connect the reactor's terminal to the power input terminal (R/L1, S/L2, T/L3) for wiring.

One-to-Many Installation (One AFE unit + Many AC motor drives)

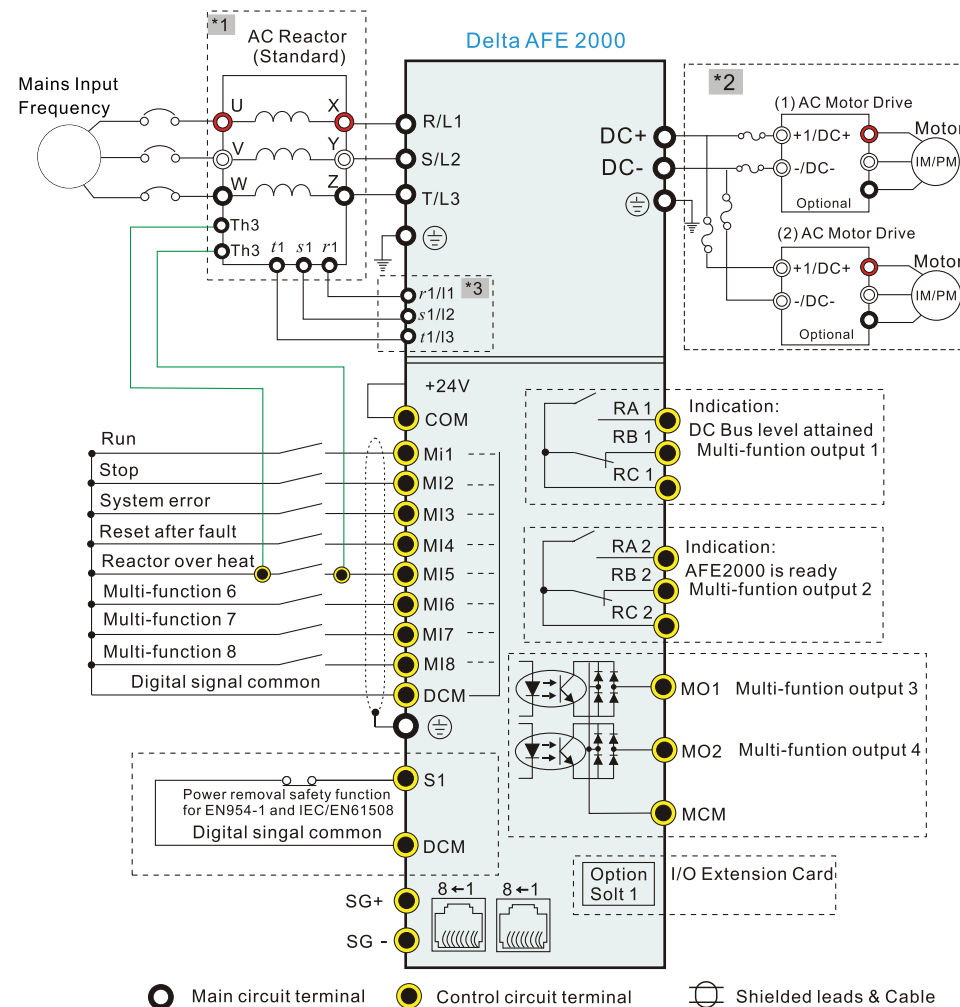

\*1 The Delta AC reactor (optional accessory) comes with a thermal protection function. When the reactor's temperature exceeds 120°C, the TH3 terminal will come ON and the AFE 2000 will receive a signal from the MI terminal to issue a warning message.

\*2 For one-to-many installation, installing a fuse on the AC motor drive's input side is recommended. Please select a compatible fuse for your AC motor drive using the equation: Fuse specification = AC rated input current / 0.78 x 1.5

\*3 If the AC reactor installed on the system is not Delta's AC reactor, please connect the reactor's terminal to the power input terminal (R/L1, S/L2, T/L3) for wiring.



AFE2000

**Dimensions**

**Frame B**

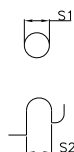
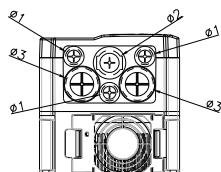
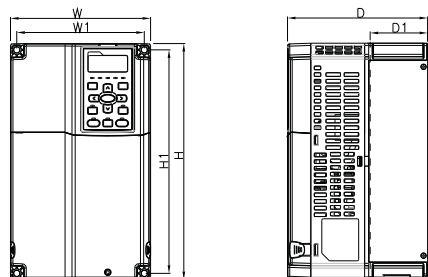

**MODEL**  
AFE075A23A  
AFE075A43A  
AFE150A43A

D1\* : Flange mounting

Frame	W	H	D	W1	H1	D1*	S1	S2	Ø1	Ø2	Ø3	
B1	mm	190.0	320.0	190.0	173.0	303.0	77.9	8.5	8.5	22.2	34.0	43.8
	inch	7.48	12.60	7.48	6.81	11.93	3.07	0.33	0.33	0.87	1.34	1.72

**Frame D**

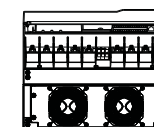
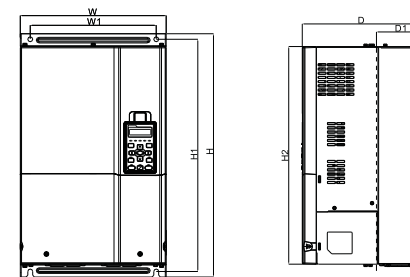

**MODEL**  
AFE370A23A  
AFE370A43A  
AFE450A43A  
AFE750A43A

D1\* : Flange mounting

Frame	W	H	D	W1	H1	H2	D1*	S1	S2	
B1	mm	330.0	550.0	275.0	285.0	525.0	492.0	107.2	11.0	11.0
	inch	12.99	21.65	10.83	11.22	20.67	19.37	4.22	0.43	0.43

**Frame C**

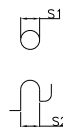
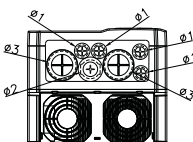
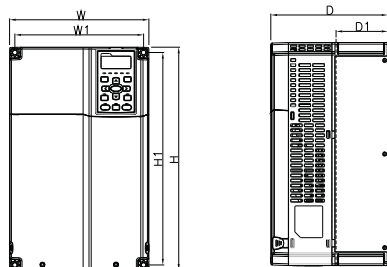

**MODEL**  
AFE150A23A  
AFE220A23A  
AFE220A43A

D1\* : Flange mounting

Frame	W	H	D	W1	H1	D1*	S1	S2	Ø1	Ø2	Ø3	
C1	mm	250.0	400.0	210.0	231.0	381.0	92.9	8.5	8.5	22.2	34.0	50.0
	inch	9.84	15.75	8.27	9.09	15.00	3.66	0.33	0.33	0.87	1.34	1.97

**Model Name**

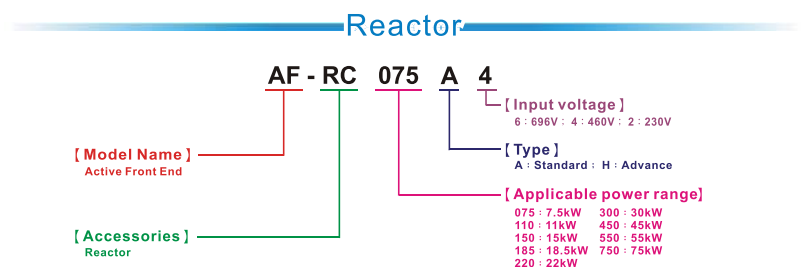
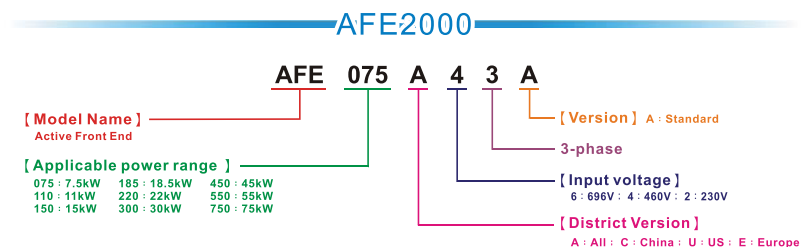

AFE2000

**Standard Reactors**

230V						
kW	Frame	Applicable Model AFE-___A23A	Reactor Model	Inductance(mH)	Rated Current (Arms)	
7.5	B	075	AF-RC075A2	2.1	35	
15	C	150	AF-RC150A2	1.05	70	
22		220	AF-RC220A2	0.77	95	
37	D	370	AF-RC370A2	0.5	150	

460V						
kW	Frame	Applicable Model AFE-___A43A	Reactor Model	Inductance(mH)	Rated Current (Arms)	
7.5	B	075	AF-RC075A4	7.32	20	
15		150	AF-RC150A4	4.18	35	
22	C	220	AF-RC220A4	2.92	50	
37		370	AF-RC370A4	1.96	75	
45	D	450	AF-RC450A4	1.54	95	
75		750	AF-RC750A4	0.92	160	

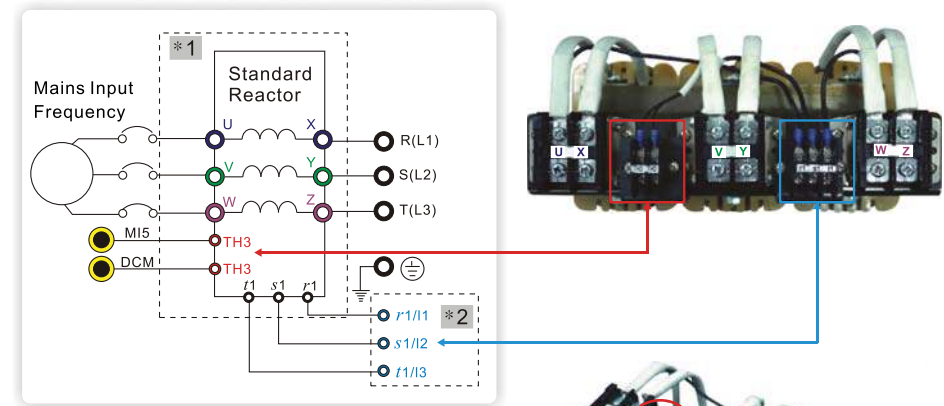

\*1 The Delta AC reactor (optional accessory) comes with a thermal protection function. When the reactor's temperature exceeds 120°C, the TH3 terminal will come ON and the AFE 2000 will receive a signal from the M1 terminal to issue a warning message.

\*2 If the AC reactor installed on the system is not Delta's AC reactor, please connect the reactor's terminal to the power input terminal (R/L1, S/L2, T/L3) for wiring.

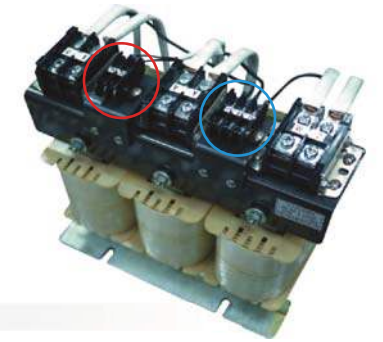

**Standard Reactor Diagram**

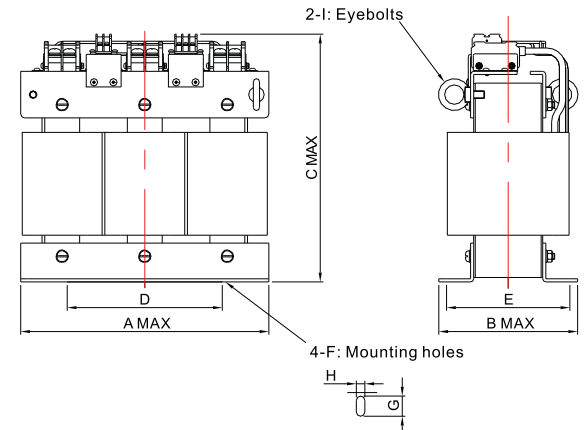

Unit : mm(inch)

Model	A	B	C	D	E	F	G	H	I	kg Approx. Mass
AF-RC075A2	305	159	280	150	125	M10	11	22	M10	28
AF-RC150A2	355	180	328	200	139	M10	11	26	M10	52
AF-RC220A2	355	200	328	200	159	M10	11	26	M10	62
AF-RC370A2	385	210	385	200	168	M12	13	25	M10	87
AF-RC150A4	355	180	328	200	139	M10	11	26	M10	52
AF-RC220A4	355	200	328	200	159	M10	11	26	M10	62
AF-RC370A4	385	210	385	200	168	M12	13	25	M10	87
AF-RC450A4	385	230	385	200	188	M12	13	25	M10	105
AF-RC750A4	420	240	440	250	200	M12	13	25	M12	137
AF-RC075A4	305	159	280	150	125	M10	11	22	M10	28

**Delta AC Motor Drives for AFE2000**

**Delta Motor Drive**

230V

440V

VFD-E, VFD-EL, VFD-VJ, VFD-VL, VFD-B, VFD-VE, VFD-F

3.7kW-22kW, 0.75kW-22kW, 0.75kW-30kW, 5.5kW-22kW

**Delta Servo Drive: ASDA-A+, ASDA-A2, ASDA-B2**