

Io=3.0A Low output voltage Adjustable LDO with dual input voltages

■ GENERAL DESCRIPTION

The NJW4111 is a ultra-low drop out adjustable regulators that delivers low output voltage from 0.8 to 1.8V with high precision and high line/load regulations.

It has also built-in over current protection, under voltage lock-out, soft start function and short circuit protection (Timer latch type).

It is suitable for a low noise constant voltage source such as the chip-set that demand a large output current up to 3.0A.

■ OUTLINE

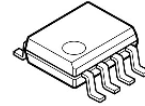

NJW4111GM1

■ FEATURES

- Dual input voltage V_{IN} : 0.8 to 3.3V
 V_{BIAS} : 4.3 to 5.5V
- Output current $I_{OUT(min.)} = 3.0A$
- High precision reference $V_{FB} = 0.65V \pm 1\%$
- Adjustable output voltage 0.8V to 1.8V
- ON/OFF function
- Discharge function
- Soft start function $T_{CS(ON)} = 3msec$ typ.
- Undervoltage lockout (UVLO) circuit
- Thermal shutdown circuit (Timer latch type)
- Over current protection
- Short circuit protection (Timer latch type)
- Package HSOP8

■ PIN CONFIGURATION

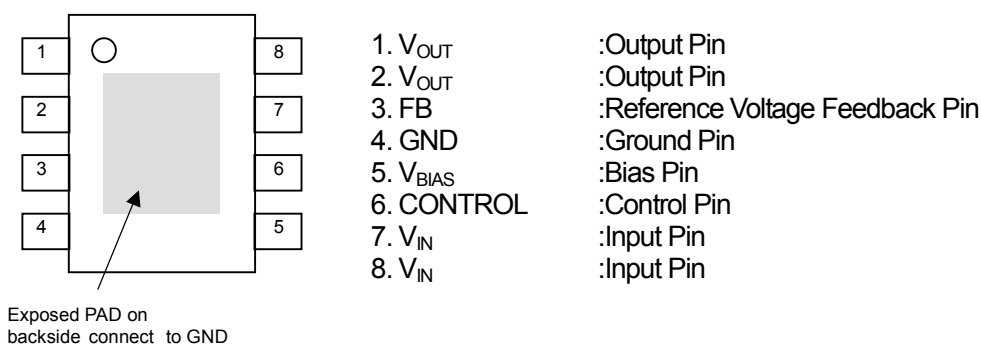

NJW4111GM1

NJW4111

■ ABSOLUTE MAXIMUM RATINGS (Ta=25°C)

PARAMETER	SYMBOL	RATINGS	UNIT
Input Voltage	V _{IN}	+4	V
Bias Voltage	V _{BIAS}	+6	V
Control Voltage	V _{CONT}	+6	V
Output Current	I _{OUT}	3	A
Power Dissipation	P _D	790(*1) 2500(*2)	mW
Junction Temperature	T _J	-40 to +150	°C
Operating Temperature	Topr	-40 to +85	°C
Storage Temperature	Tstg	-40 to +150	°C

(*1) : Mounted on glass epoxy board. (76.2×114.3×1.6mm: based on EIA/JDEC standard, 2Layers)

(*2) : Mounted on glass epoxy board. (76.2×114.3×1.6mm: based on EIA/JDEC standard, 4Layers)

(For 4Layers : Applying 74.2 x 74.2mm inner Cu area and a thermal via hole to a board based on JEDEC standard JESD51-5)

■ RECOMMENDED OPERATING CONDITIONS

PARAMETER	SYMBOL	MIN.	TYP.	MAX.	UNIT
Input Voltage	V _{IN}	0.8	-	3.3	V
Bias Voltage	V _{BIAS}	4.3	-	5.5	V
Control Voltage	V _{CONT}	-0.3	-	5.5	V
Output voltage Range	V _{OUT}	0.8	-	1.8	V

■ BUILT-IN PROTECTION CIRCUIT

PARAMETER	NOTE
Over current protection	-
Short circuit protection	Timer latch type
Thermal shutdown circuit	Timer latch type

■ BUILT-IN FUNCTION

PARAMETER	NOTE
Soft start Function	3msec typ.
V _{IN} -UVLO	0.73V typ.
V _{BIAS} -UVLO	3.8V typ.
Power supply injection sequence-free	-

■ ELECTRICAL CHARACTERISTICS

(Unless otherwise specified, $V_{BIAS}=5V$, $V_{CONT}=3V$, $V_{IN}=V_{OUT}+0.5V$, $C_{BIAS}=1\mu F$, $C_{IN}=22\mu F$, $C_O=10\mu F$, $C_{FB}=1000pF$, $T_a=25^\circ C$)

General Characteristic

PARAMETER	SYMBOL	CONDITION	MIN.	TYP.	MAX.	UNIT
Bias Current	$I_{Q(VBIAS)}$	$I_{OUT}=0mA$, except I_{CONT}	-	1.4	2.2	mA
Bias Current at OFF	$I_{Q(VBIAS/OFF)}$	$V_{CONT}=0V$	-	-	100	nA
Input Current at OFF	$I_{Q(VIN/OFF)}$	$V_{CONT}=0V$	-	-	100	nA
Feedback Voltage	V_{FB}		-1.0%	0.65	+1.0%	V
Output Current	I_{OUT}	$V_{OUT} \times 0.9$	3.0	-	-	A
Line Regulation (V_{BIAS})	$\Delta V_O / \Delta V_{BIAS}$	$V_{BIAS}=4.2V$ to $5.5V$, $I_{OUT}=30mA$	-	-	0.5	%/V
Line Regulation (V_{IN})	$\Delta V_O / \Delta V_{IN}$	$V_{IN}=V_{OUT}+0.5V$ to $3.3V$, $I_{OUT}=30mA$	-	-	0.5	%/V
Load Regulation	$\Delta V_O / \Delta I_O$	$I_{OUT}=0mA$ to $3A$	-	-	10	mV
Output ON Resistance	R_{ON}	$I_{OUT}=3A$, $V_{IN}=1.1V$	-	28	50	$m\Omega$
Discharge Current at OFF	$I_{O(OFF)}$	$V_{CONT}=0V$, $V_{OUT}=1V$	1	-	-	mA
Feedback Current	I_{FB}		-100	0	+100	nA
V_{IN} Pin Leak Current	$I_{LEAK(VIN)}$	$V_{BIAS} = V_{CONT} = 5V$, $V_{IN}=0V$	-	0.25	0.60	μA

ON/OFF Control Block

PARAMETER	SYMBOL	CONDITION	MIN.	TYP.	MAX.	UNIT
Control Voltage for ON-state	$V_{CONT(ON)}$	V_{CONT} : Sweep up	1.6	-	-	V
Control Voltage for OFF-state	$V_{CONT(OFF)}$	V_{CONT} : Sweep down	-	-	0.6	V
Control Current	I_{CONT}	$V_{CONT}=1.6V$	1	3	12	μA
Soft Start Time	$T_{CS(ON)}$	$V_{CONT}=L \rightarrow H$	-	3	-	msec

UVLO Block

PARAMETER	SYMBOL	CONDITION	MIN.	TYP.	MAX.	UNIT
V_{BIAS} Undervoltage Lockout Threshold Voltage	$V_{BIASUVLO}$	V_{BIAS} : Sweep up	3.5	3.8	4.1	V
V_{BIAS} Undervoltage Lockout Hysteresis Voltage	$V_{BIASHYS}$	V_{BIAS} : Sweep down	100	160	220	mV
V_{IN} Undervoltage Lockout Threshold Voltage	V_{INUVLO}	V_{IN} : Sweep up	0.71	0.73	0.75	V

SCP Block

PARAMETER	SYMBOL	CONDITION	MIN.	TYP.	MAX.	UNIT
SCP Start up Voltage	V_{OCSP}		$V_o \times 0.32$	$V_o \times 0.33$	$V_o \times 0.34$	V
SCP Timer Latch Time	T_{SCP}		-	200	-	μsec

NJW4111

■ BLOCK DIAGRAM

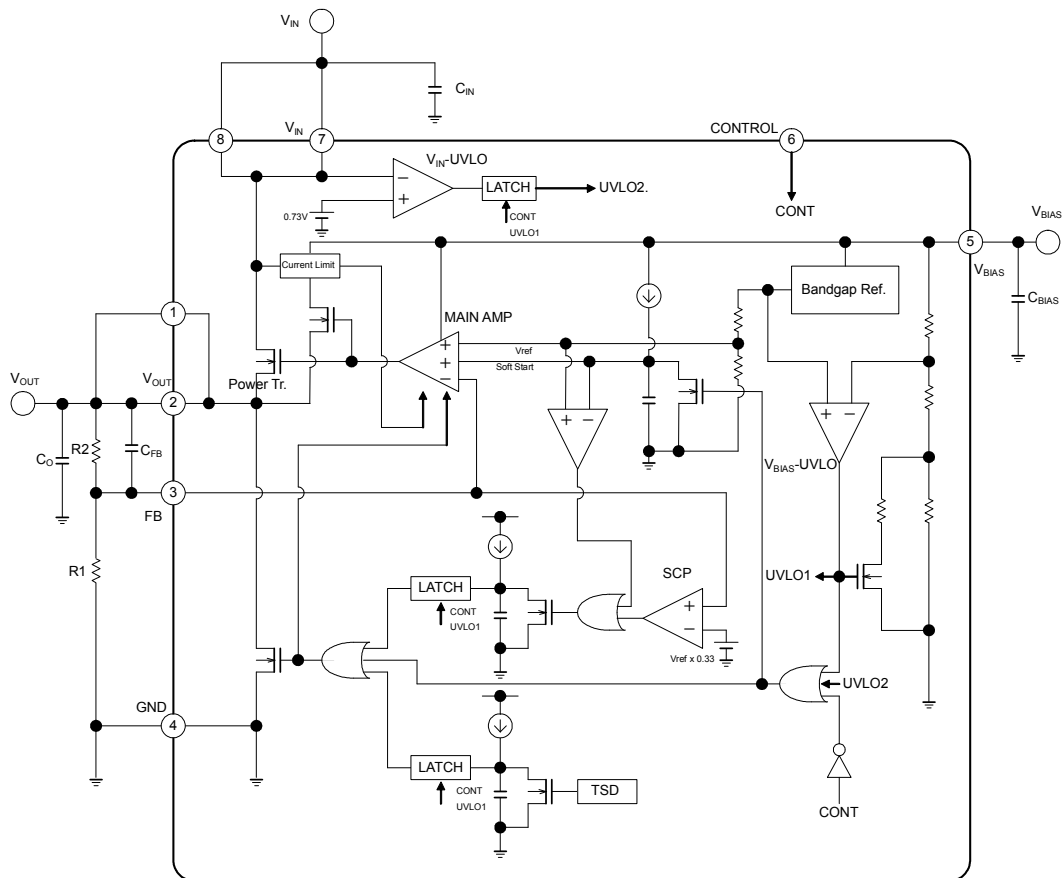

■ POWER DISSIPATION vs. AMBIENT TEMPERATURE

NJW4111GM1 PowerDissipation
(Topr=-40~+85°C, Tj=150°C)

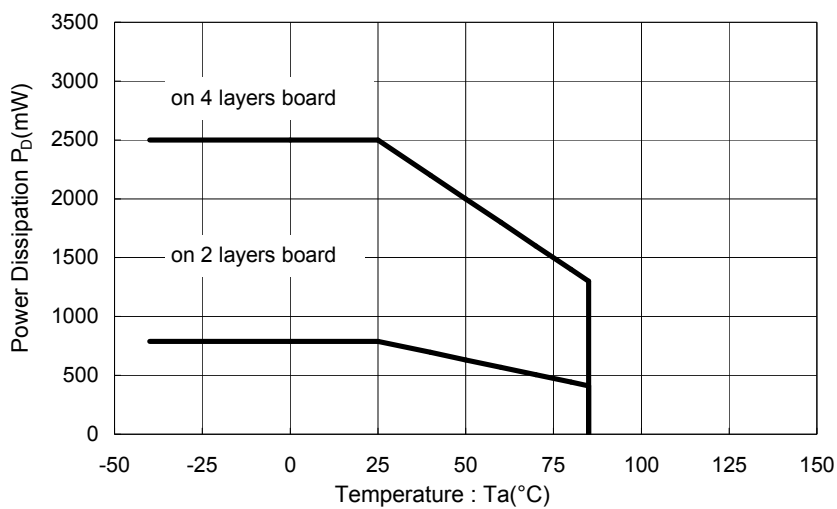

■ PIN DESCRIPTIONS

PIN NUMBER	PIN NAME	FUNCTION
1	V_{OUT}	Output pin. It can be adjusted from 0.8V to 1.8V.
2	V_{OUT}	Output pin. It can be adjusted from 0.8V to 1.8V.
3	FB	Output Voltage Detecting pin. Control output voltage that FB pin voltage should become the reference voltage 0.65V/typ.
4	GND	GND pin.
5	V_{BIAS}	Power supply for IC Control bias. Insert the capacitor between V_{BIAS} pin and GND pin for reduce the power supply impedance.
6	CONTROL	ON/OFF control pin for NJW4111. Normal Operation at the time of High level. Standby Mode at the time of Low level or Open.
7	V_{IN}	Power supply for power line. Insert the capacitor between V_{IN} pin and GND pin for reduce the power supply impedance.
8	V_{IN}	Power supply for power line. Insert the capacitor between V_{IN} pin and GND pin for reduce the power supply impedance.
-	Exposed PAD	Connected to GND pin.

■ DESCRIPTION OF EACH BLOCK

• MAIN AMP

This is an error amp compares the reference voltage (0.65V) with V_{FB} to drive the output Nch-MOSFET. This amp's phase compensation is designed to be able to use a very low ESR capacitor from 0.02Ω.

• CONTROL

Control block switches the regulator's ON/OFF state. In the OFF state, circuit current is maintained at 0μA, and minimize current consumption at standby. Discharge circuit, connected to the V_{OUT} pin, pulls up an unnecessary electric charge and prevents the malfunction of the load side in the OFF state.

• V_{BIAS} - UVLO

ULVO block for bias voltage turns the output voltage off to prevent malfunction when V_{BIAS} is the threshold voltage or less. At the time of the lockout, discharges output voltage in the same way as OFF state.

• V_{IN} - UVLO

When the V_{IN} voltage is beyond 0.73V(typ.), UVLO block for input voltage turns the output on. The output does not turn off when once a lockout is released even if the V_{IN} voltage falls. But, when the V_{IN} voltage falls and the V_{OUT} voltage falls below the SCP threshold voltage, turn the output off due to SCP. The V_{IN} -UVLO is available only at the time of startup. If the V_{CONT} or the V_{BIAS} is re-injected, V_{IN} -UVLO will be available again.

• Over Current Protection

This circuit protects an IC of the load side to damp the output voltage when output current exceeds the constant value. When the overcurrent state eliminated, output voltage restored to the parameter value. However when output voltage is less than SCP startup voltage, the SCP function becomes active and output switches OFF

• Thermal Shutdown (TSD)

Thermal Shutdown circuit is latched OFF the output when the chip temperature exceeds the threshold temperature after the programmed time period elapses. Because equipped with a latch function, maintain an Off state till apply CONTROL or V_{BIAS} again. Because TSD circuit is built-in for the purpose of protecting IC itself, please do the thermal design within $T_j(\text{max})$.

NJW4111

Short Circuit Protection(SCP)

When output voltage drops, NJW4111 assumes that V_{OUT} pin is shorted to GND and switched output OFF after a certain period of time. Because equipped with a latch function, maintain an Off state till apply CONTROL or V_{BIAS} again.

When SCP becomes effective, and an output current is intercepted, please be careful the voltage more than the maximum rating be never impressed on a V_{IN} pin.(refer to *4)

For prevention of malfunction on start up, this circuit becomes invalid at the time of the start (effective Soft start function) temporarily.

TEST CIRCUIT

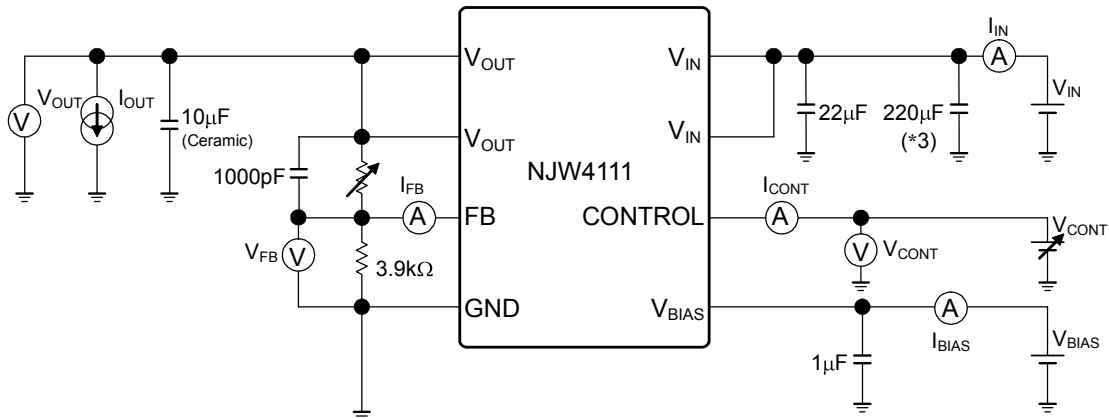

(*3)Provision for supply impedance of the measuring instrument

TYPICAL APPLICATION

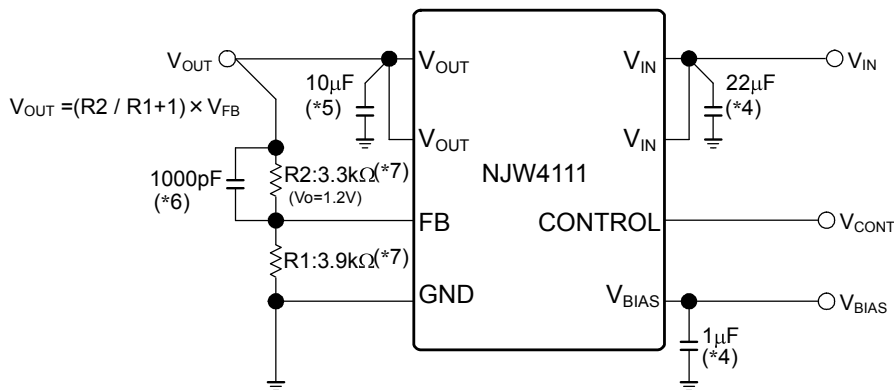

(*4) Input Capacitor C_{IN} , Bias Capacitor C_{BIAS}

Input Capacitor C_{IN} and Bias Capacitor C_{BIAS} are required to prevent oscillation and reduce power supply ripple for applications with high power supply impedance or a long power supply line. Please use the C_{IN} of recommended value larger to avoid the problem. ($C_{BIAS} \geq 1.0\mu F, C_{IN} \geq 22\mu F$)

C_{IN} and C_{BIAS} should connect between GND and V_{IN} , V_{BIAS} as shortest path as possible.

Recommend large capacity value C_{IN} because tend to become unstable in input voltage (V_{IN}) when a load change is heavy.

Please for enough confirmation with the actual machine to strongly depend on the characteristic of power supply to use for inputs and the pattern of the board.

(*5) Output Capacitor C_O

Output capacitor (C_O) will be required for a phase compensation of the internal error amplifier.

The capacitance and the equivalent series resistance (ESR) influence to stable operation of the regulator.

This product is designed to work with a low ESR capacitor (C_O). However use of recommended capacitance or larger value is effective for stable operation.

Use of a smaller C_O may cause excess output noise or oscillation of the regulator due to lack of the phase compensation.

Therefore use C_O with the recommended capacitance or larger value and connect between V_{OUT} pin and GND pin with shortest path. The recommended capacitance depends on the output voltage rank. Low voltage regulator requires larger value C_O . Thus, check the recommended capacitance for each output voltage rank.

Uses of a larger C_O reduces output noise and ripple output, and also improves output transient response against rapid load change.

It depends on the pattern of the board and power supply use for input, Power supply(V_{IN}) becomes unstable and tends to be easy to cause an oscillation, aggravation of Ripple Rejection and output transient response characteristics when design it $C_{IN} < C_O$.

Therefore, like a mention of the (*4), please connect C_{IN} of enough capacity value, and improve stabilization of input power supply (V_{IN}).

In addition, you should consider varied characteristics of capacitor (a frequency characteristic, a temperature characteristic, a DC bias characteristic and so on) and unevenness peculiar to a capacitor supplier enough.

When selecting C_O , recommend that have withstand voltage margin against output voltage and superior temperature characteristic though this product is designed stability works with wide range ESR of capacitor including low ESR products.

(*6) Feedback Capacitor C_{FB}

Please insert the C_{FB} for stable operation by all means.

It correct phase compensation of the IC inside and can support the output capacitor of various kinds by adjustment capacitance of C_{FB} .

(*7) Output voltage setting resistance $R1, R2$

Output voltage can be set with a configuration formula $(R2/R1+1) \times V_{FB}$ using the values for the internal reference output voltage(V_{FB}) and the output voltage resistors($R1, R2$).

Select resistance values that will avoid the influence of the Feedback Current $I_{FB}(\pm 100nA)$.

The recommended total resistance value is about $10k\Omega$

NJW4111

TYPICAL CHARACTERISTICS

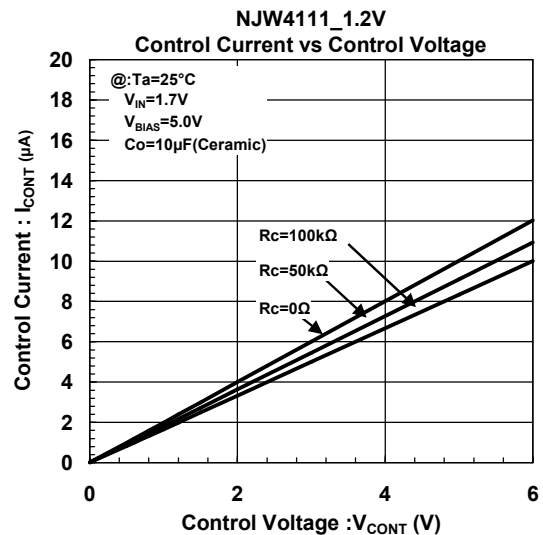
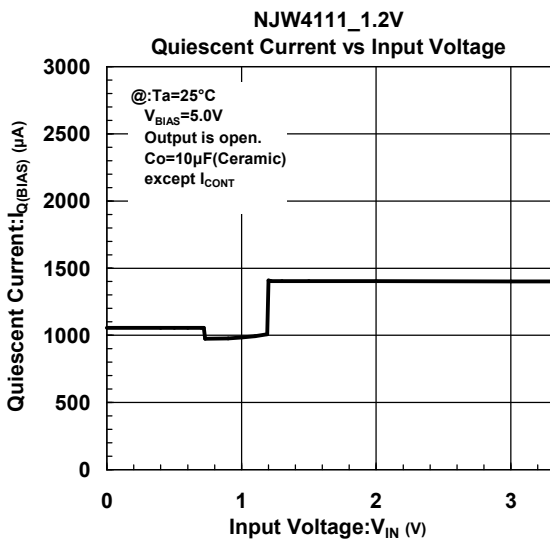
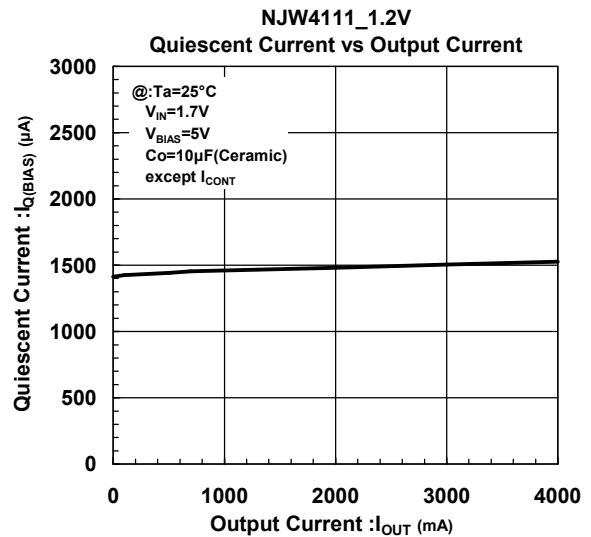
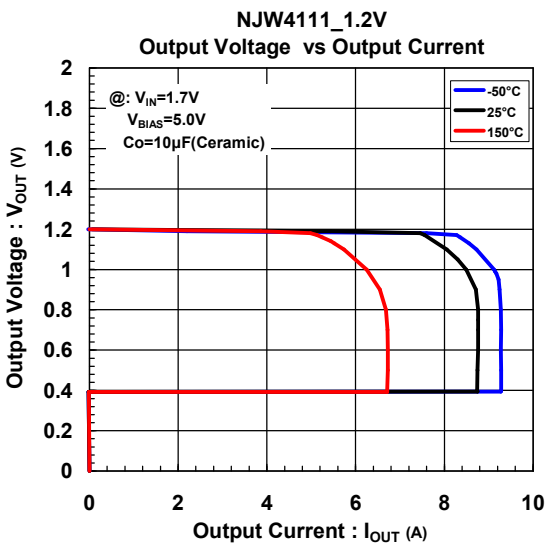
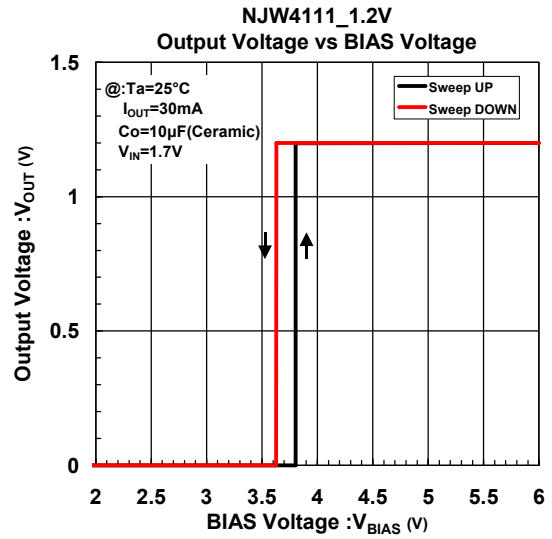
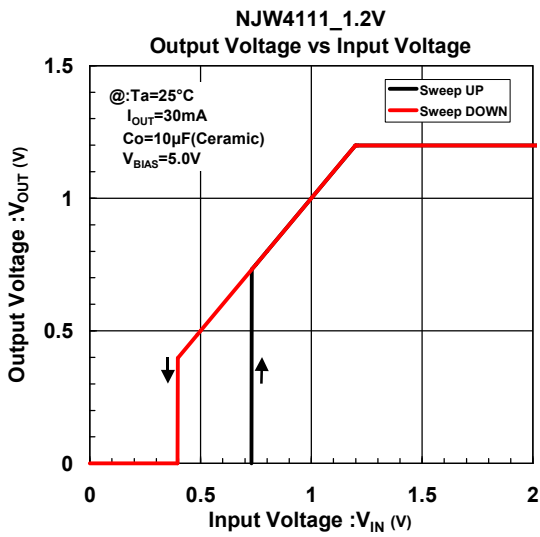

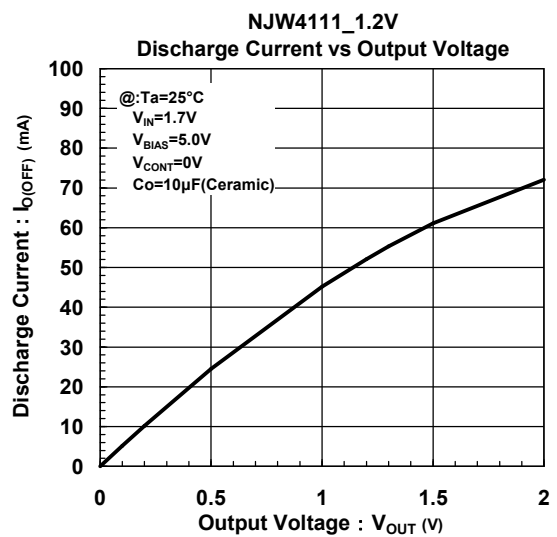
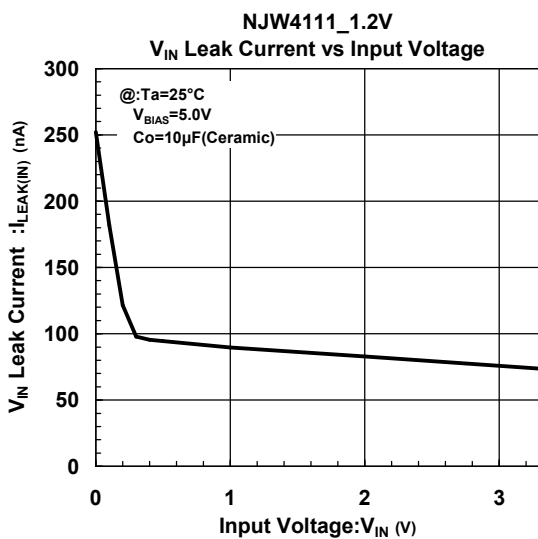
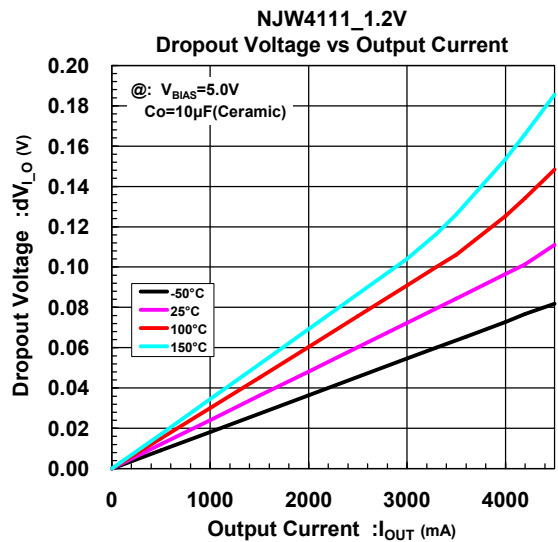
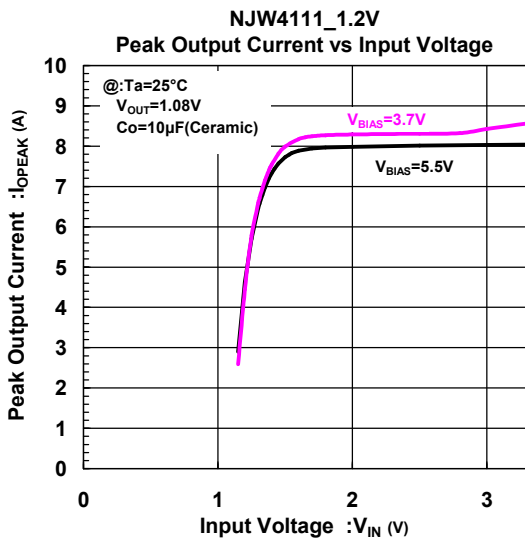
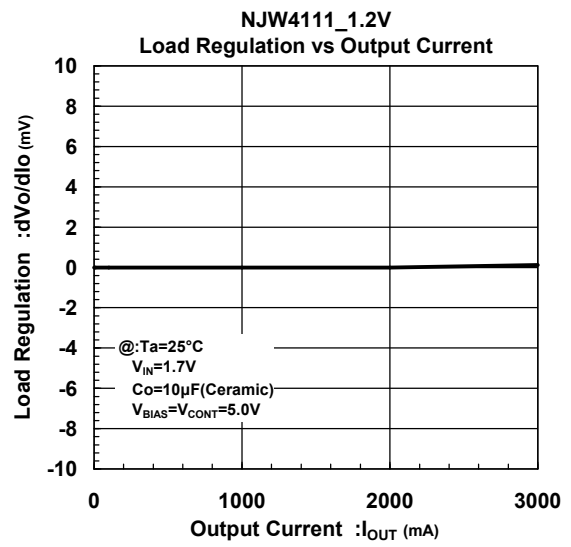
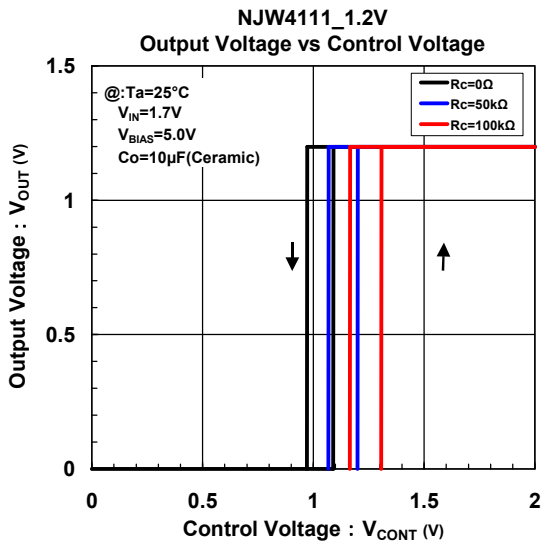

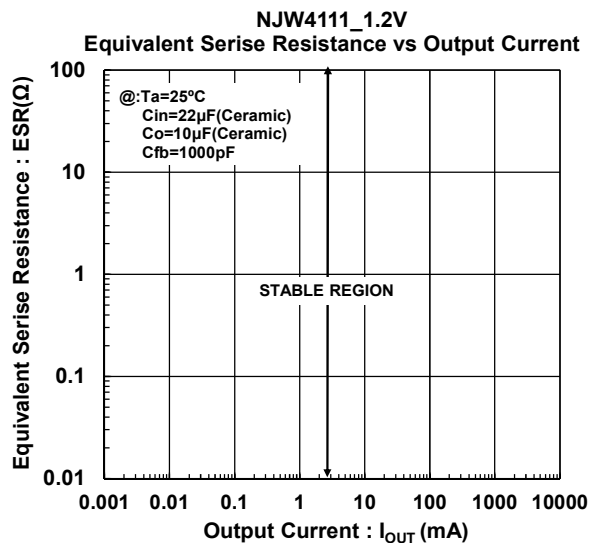
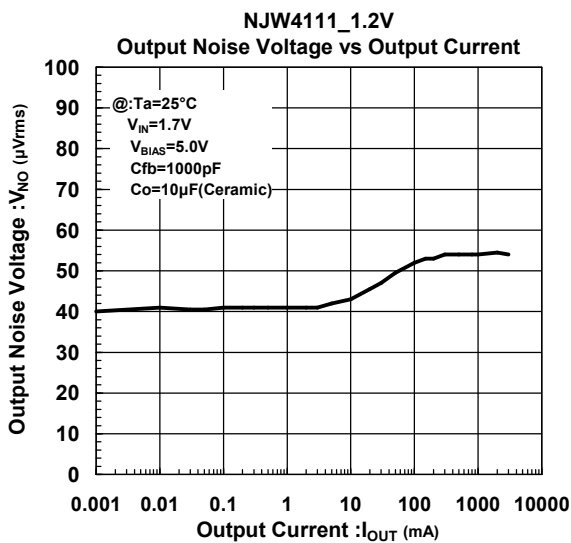
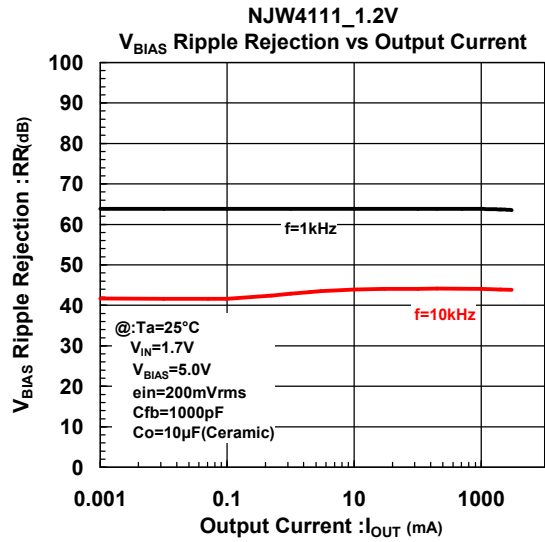
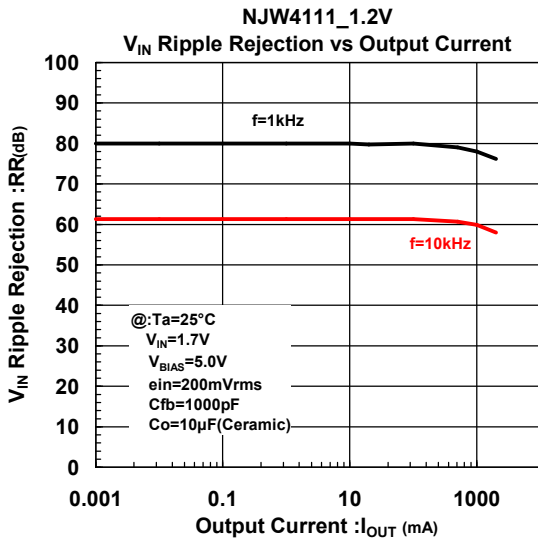
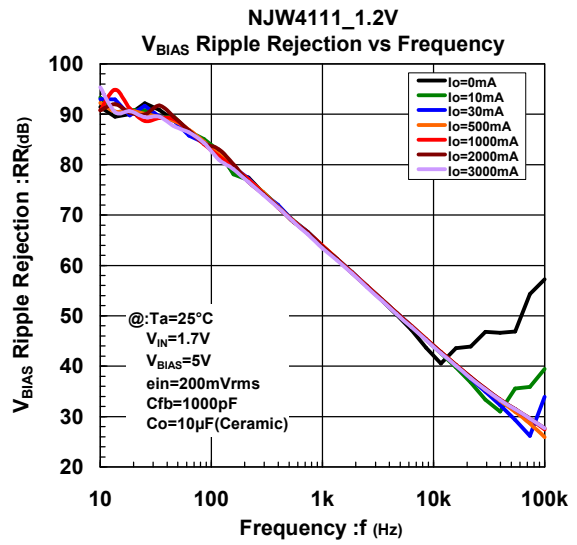
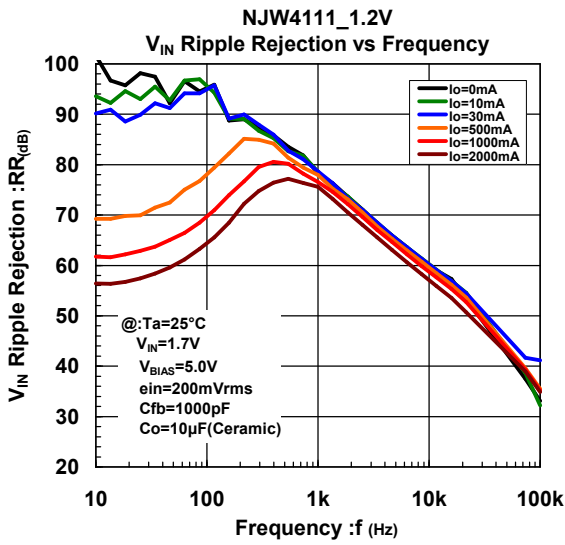

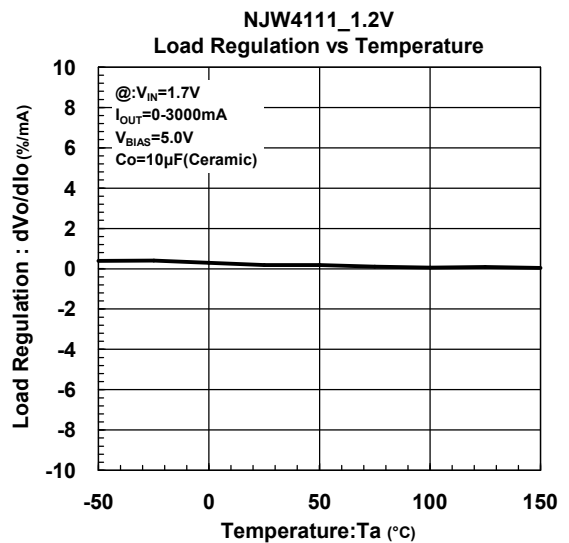
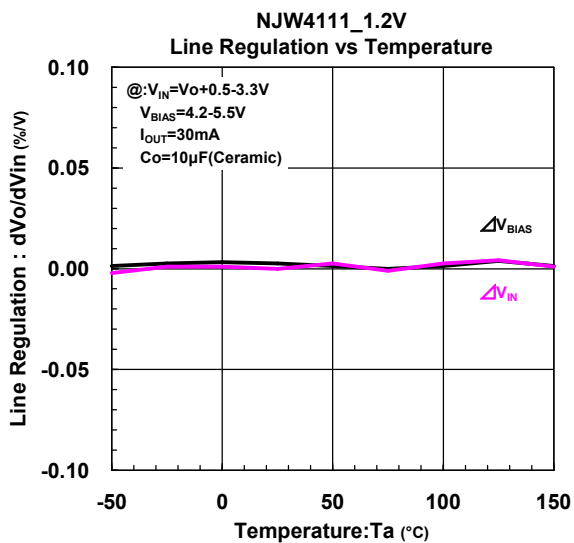
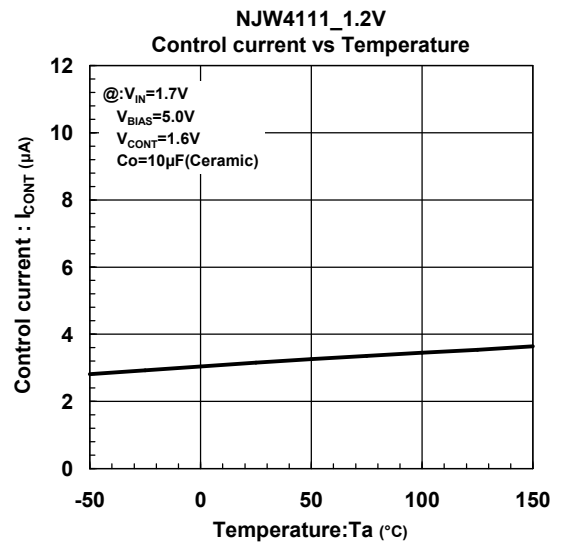
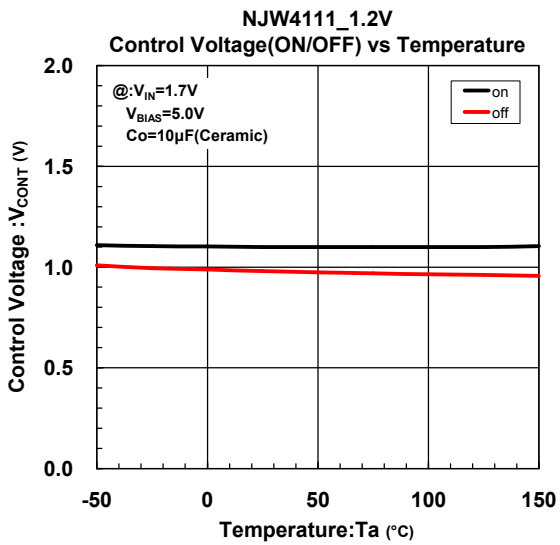
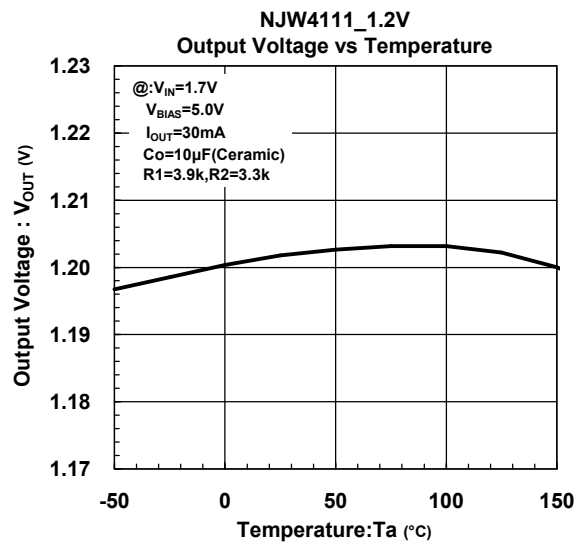
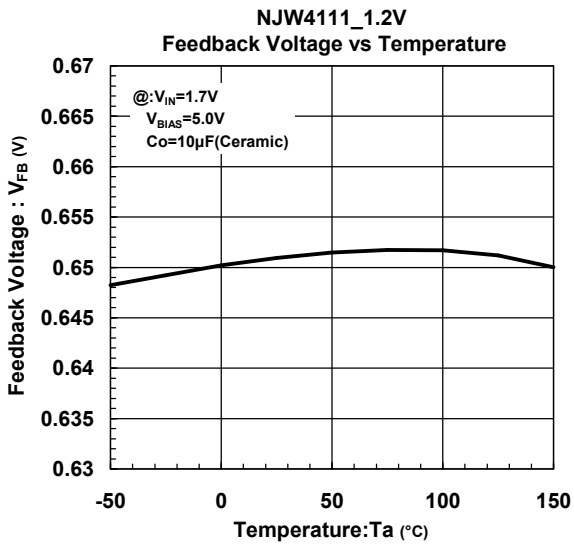

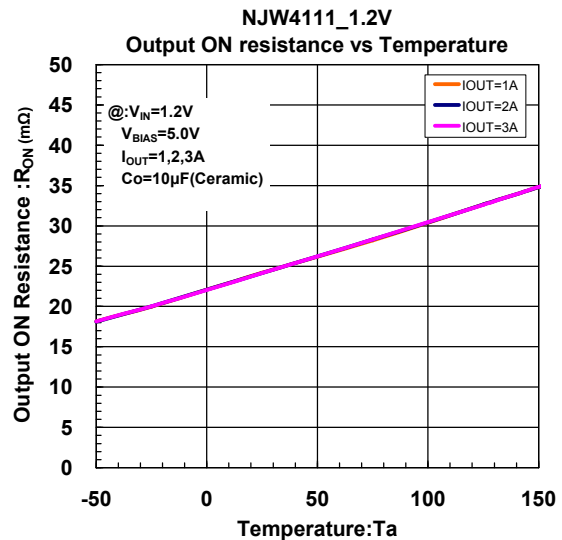
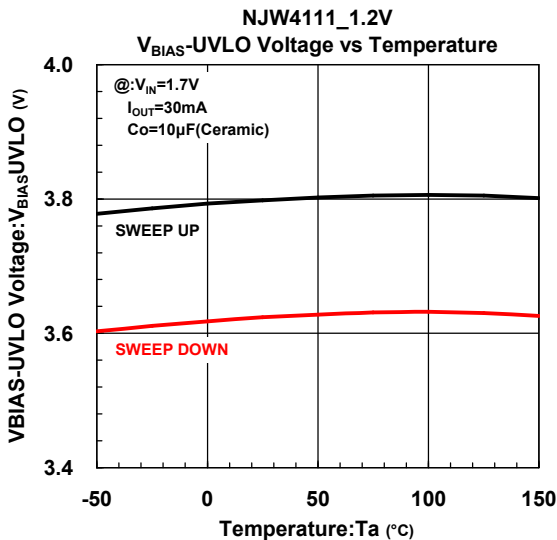
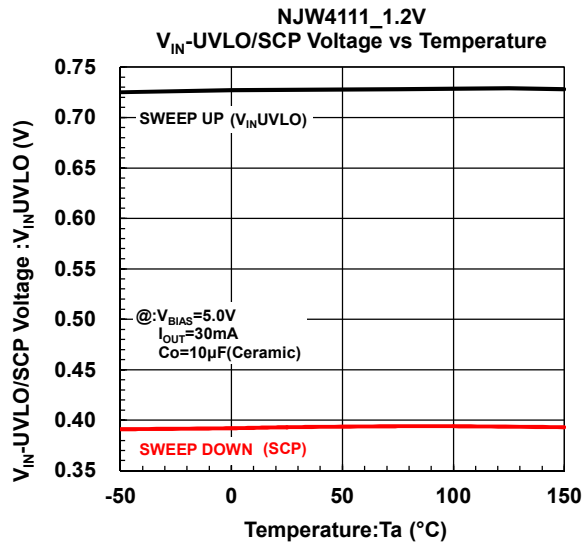
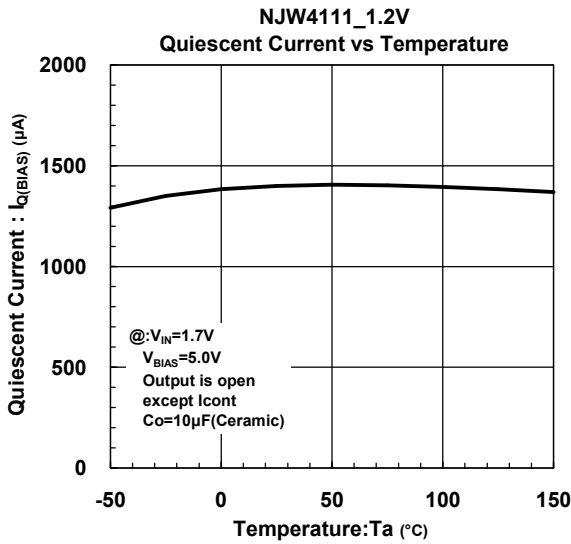
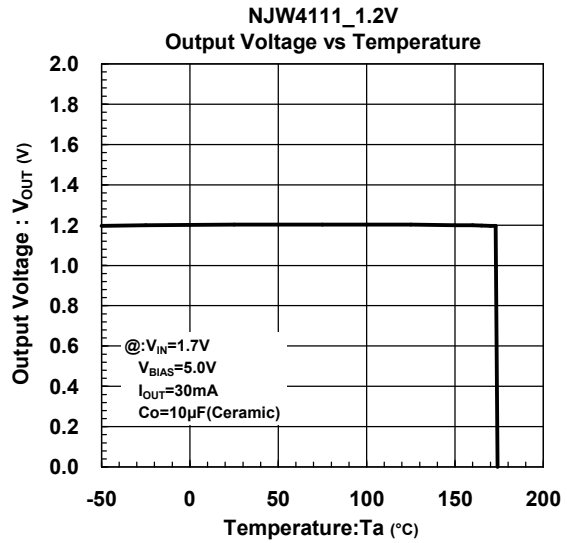
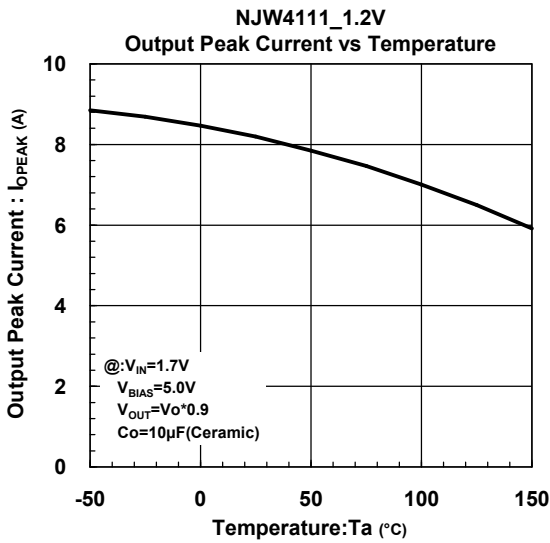

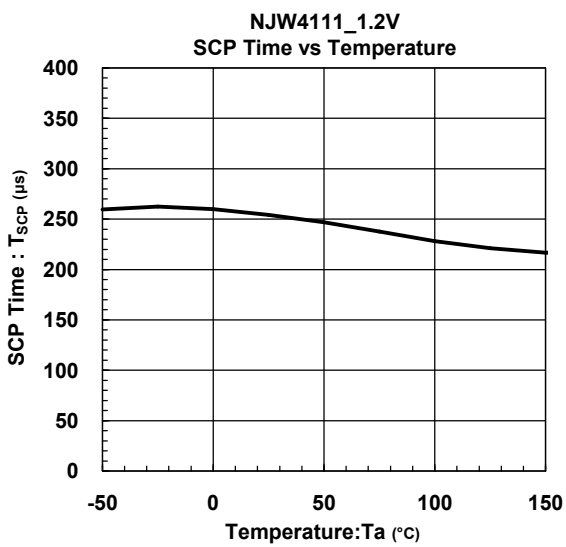
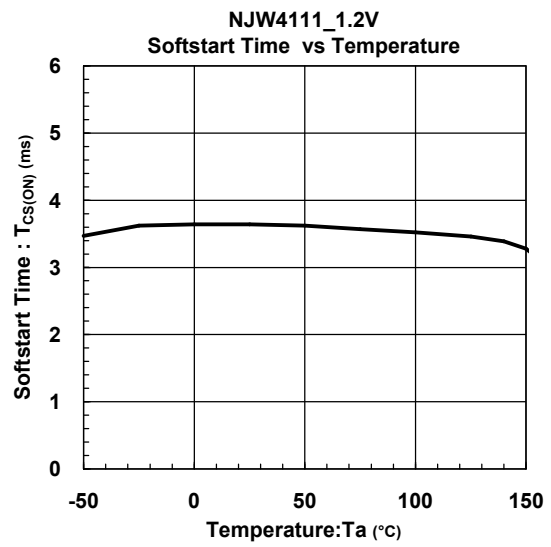
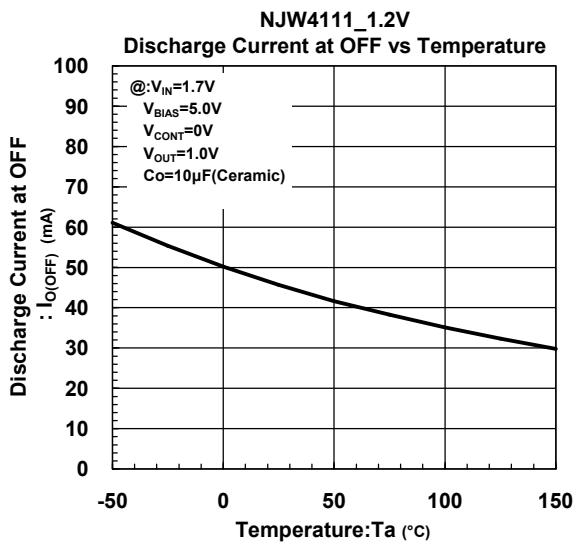

NJW4111

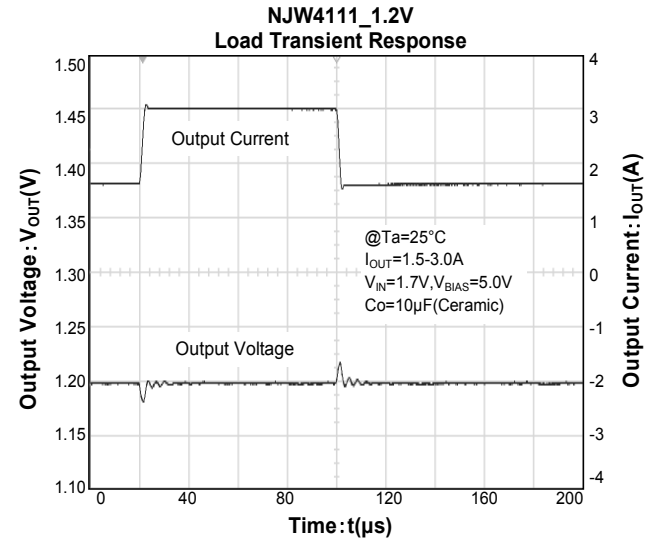
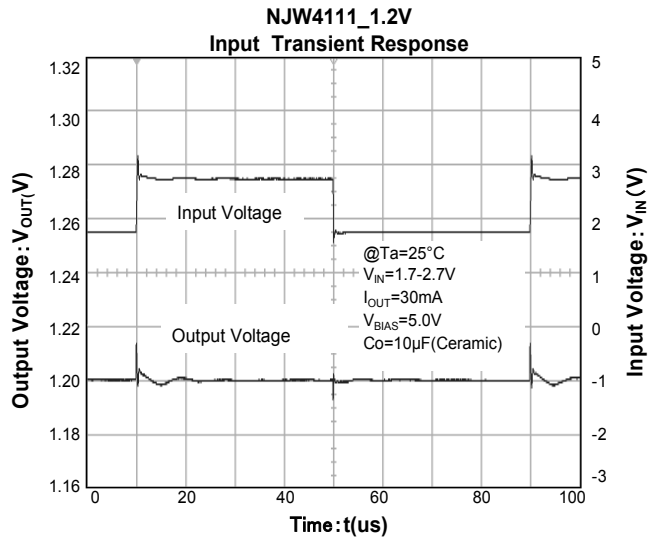
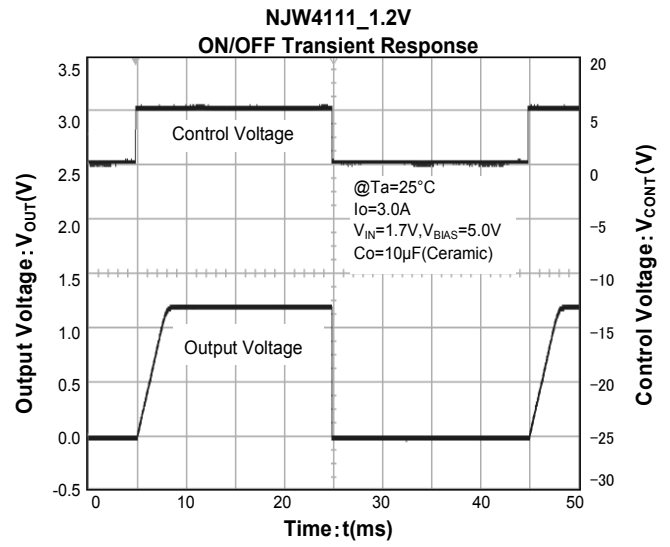
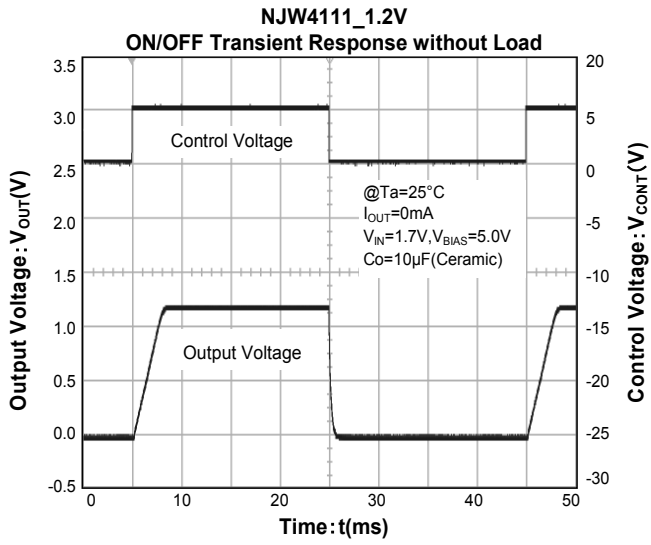

[CAUTION]
The specifications on this databook are only given for information, without any guarantee as regards either mistakes or omissions. The application circuits in this databook are described only to show representative usages of the product and not intended for the guarantee or permission of any right including the industrial rights.