

E-Z-NAILCLIP™ TEST TERMINAL ADAPTERS

HEAVY DUTY TERMINAL CLIP ON THREADED POST

SEE PART NO. BOX FOR PANEL THICKNESS

Part No.	Thread	Max Panel Thickness
8607-4	4-40	.875"
8607-6	6-32	.875"
8607-8	8-32	1.00"
8607-10	10-32	.875"

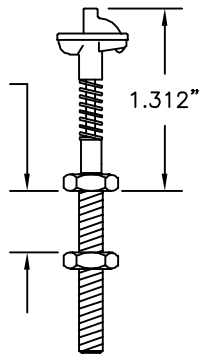

Colors: Available in 10 colors.
See Part No. 81-1 for hook dimensions

TERMINAL CLIP ON SMALL RING TERMINAL

FOR NO. 10 SCREW .200" DIA.

Part No.	Description
8105	Terminal Clip on Small Eyelet

Colors: Available in 10 colors.

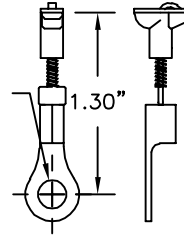

See Part No. 81-1 for hook dimensions

TERMINAL CLIP ON METER POST RING TERMINAL

FOR 1/4" SCREW .250" DIA.

Part No.	Description
8106	Terminal Clip on Meter Post Eyelet

Colors: Available in 10 colors.

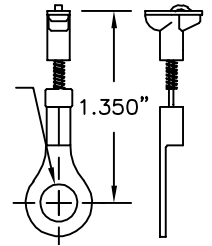

See Part No. 81-1 for hook dimensions

TERMINAL CLIP ON .080" (2.03mm) PIN

Part No.	Description
8101	Terminal Clip on .080" (2.03mm) Pin

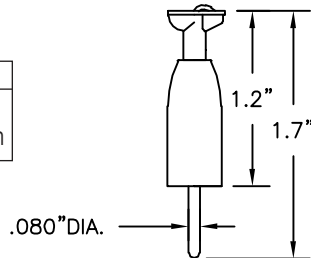

Colors: Available in 10 colors.
See Part No. 81-1 for hook dimensions

TERMINAL CLIP ON THREADED POST

SEE PART NO. BOX FOR PANEL THICKNESS

Part No.	Thread	Max Panel Thickness
8107-4	4-40	.875"
8107-6	6-32	.875"
8107-8	8-32	1.00"
8107-10	10-32	.875"

Colors: Available in 10 colors.
See Part No. 81-1 for hook dimensions

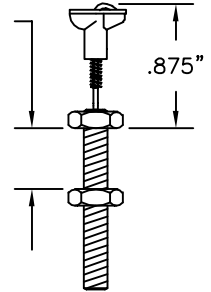

TERMINAL CLIP ON STANDARD BANANA PLUG

Part No.	Description
8102	Terminal Clip on Standard Banana Plug

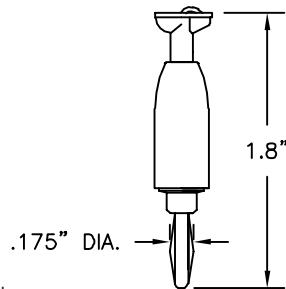

Colors: Available in 10 colors.
See Part No. 81-1 for hook dimensions

TERMINAL CLIP ON .250" (6.35mm) SPADE LUG

Part No.	Description
8104	Terminal Clip on .250" (6.35mm) Spade Lug

Colors: Available in red and black.
See Part No. 81-1 for hook dimensions

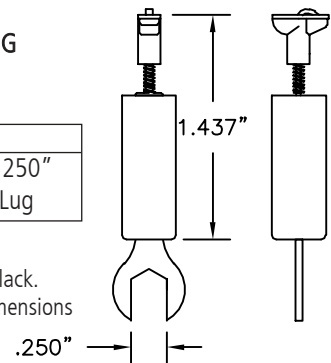

TERMINAL CLIP ON MINIATURE BANANA PLUG

Part No.	Description
8108	Terminal Clip on Miniature Banana Plug

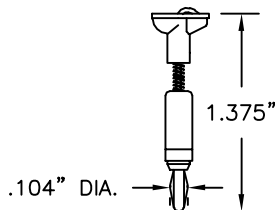

Colors: Available in 10 colors.
See Part No. 81-1 for hook dimensions

TERMINAL CLIP ON STANDARD DOUBLE BANANA PLUG

Part No.	Description
8103	Terminal Clip on Std. Double Banana Plug

Colors: Available in red and black.
See Part No. 81-1 for hook dimensions

