

ITEM NO.	PART NUMBER	DESCRIPTION	QTY.	COMPONENT NOTES
1	50-00027	Connector, dc jack, 5.5x2.5xL17.4 mm, molding style	1	
2	30-00683	Wire, 2C TS, 18 AWG, UL2464, 300V, 80C, 5.2 mm, VW-1, PVC	1	
3	24-00183	Overmold, dc jack, 5.5 mm, Tensility	1	black

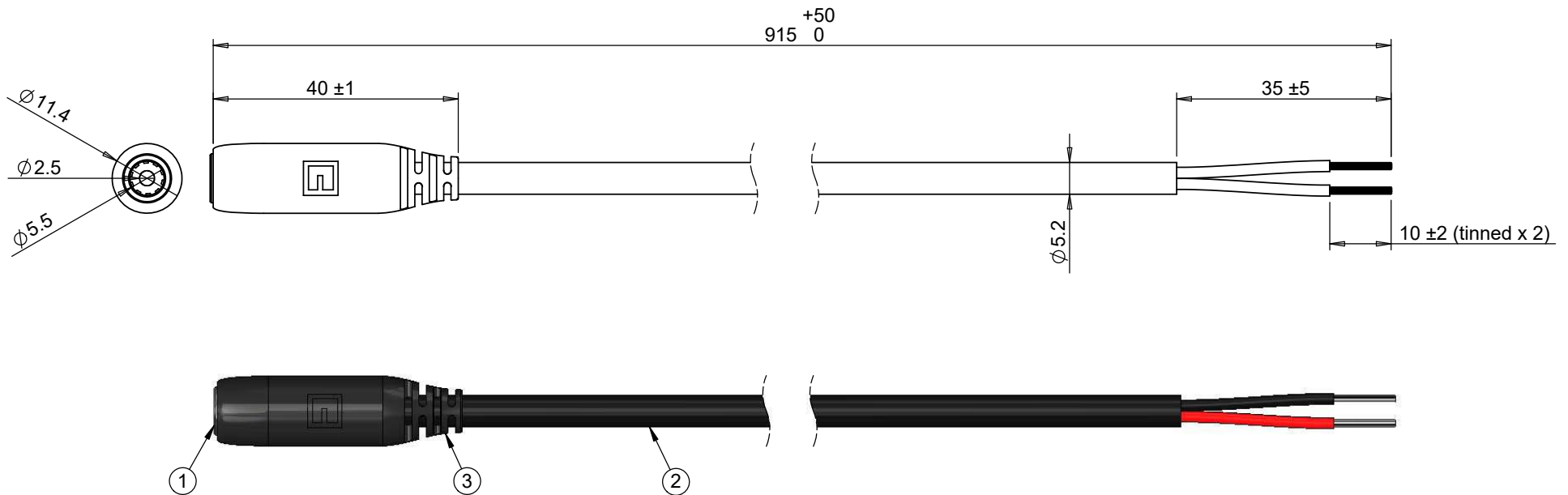

Notes:
Functionally equivalent components may be substituted

Electrical requirements: 7 A, 12 Vdc

Wiring Diagram	
50-00027	wire color
center	red
sleeve	black

Revision:	Date:	Description:	Prepared:	Notes:	<h1>TENSILITY</h1> <p>tel 1.541.323.3228 800 877.670.7118 fax 1.541.323.4202 web tensility.com</p>
A	9/13/2016	Initial release	DN <small>Digitally signed by DN Date: 2017.01.30 14:14:56 -08'00'</small>	RoHS compliant	
			Verified: PS <small>Digitally signed by PS Date: 2017.01.30 15:33:28 -08'00'</small>	Function test: no open, no short circuit, no intermittent	
			Dimensions are in millimeters. Tolerances: X: ± 0.5 mm X.X: ± 0.3 mm X.XX: ± 0.05 mm	Description: Cable, 915 mm, 5.5x2.5 mm 50-00027 dc jack to stripped tinned, 18 AWG, 30-00683 wire	
Scale: 1:1				Size: A	Part number: 10-02245
				Sheet 1 of 1	