



## IQS227D DATASHEET

Single Channel Capacitive Proximity and Touch Controller

The **IQS227D** ProxSense® IC is a fully integrated Self Capacitive sensor with dual outputs (Touch and Proximity outputs).

### Features

- > **Sub 5 $\mu$ A** in Low Power Mode while sensing Proximity
- > **Automatic Tuning Implementation (ATI)** - Automatic tuning of sense electrode
- > **Internal Capacitor Implementation (ICI)** - reference capacitor on-chip
- > Supply voltage: 2.4 V to 5 V
- > Minimum external components
- > Data streaming option
- > Advanced on-chip digital signal processing
- > User selectable (OTP) :
  - 4 Power Modes
  - IO sink/ source
  - Time-out for stuck key
  - Output mode (Direct/Latch/Toggle)
  - Proximity and Touch Button sensitivity



RoHS2  
Compliant

6 pin DFN-6  
Representation only, not  
actual markings

### Applications

- > LCD, Plasma & LED TVs
- > GSM cellular telephones - On ear detection / touch keys
- > LED flashlights or headlamps
- > White goods and appliances
- > Office equipment, toys, sanitary ware
- > Flameproof, hazardous environment Human Interface Devices
- > Proximity detection enables backlighting activation
- > Wake-up from standby applications
- > Replacement for electromechanical switches
- > Find-In-The-Dark (FITD) applications
- > Automotive: Door pocket lighting, electric window control
- > GUI trigger on Proximity detected

### Available Options

T <sub>A</sub>	DFN-6
-40°C to 85°C	IQS227D



## Contents

<b>1 Overview</b>	<b>5</b>
1.1 Device . . . . .	5
1.2 Applicability . . . . .	5
1.3 Analogue Functionality . . . . .	5
<b>2 Packaging and Pin-Out</b>	<b>6</b>
2.1 IQS227D . . . . .	6
2.1.1 Pin-out . . . . .	6
2.2 Schematic . . . . .	7
2.2.1 DFN-6 . . . . .	7
2.3 Recommended Capacitor Values . . . . .	7
2.4 Exception to recommended capacitor values . . . . .	8
<b>3 User Configurable Options</b>	<b>9</b>
3.1 Configuring of Devices . . . . .	9
<b>4 Measuring Capacitance Using the <i>Charge Transfer</i> Method</b>	<b>11</b>
<b>5 Descriptions of User Options</b>	<b>12</b>
5.1 Proximity / Touch Sensor . . . . .	12
5.2 Logic select for outputs . . . . .	12
5.3 Output Pin Function . . . . .	12
5.3.1 Output function: Active . . . . .	13
5.3.2 Output function: Latch (for $t_{LATCH}$ ) . . . . .	13
5.3.3 Output function: Toggle . . . . .	13
5.4 Proximity Threshold . . . . .	14
5.5 Touch Threshold . . . . .	14
5.6 Power Modes . . . . .	15
5.7 Base Values . . . . .	15
5.8 ATI Target Counts . . . . .	16
5.9 Charge Transfer . . . . .	16
5.10 Filters used by the IQS227D . . . . .	16
5.10.1 Long Term Average (LTA) . . . . .	16
5.10.2 IIR Raw Data filter . . . . .	17
<b>6 Data Streaming Mode</b>	<b>18</b>
6.1 I <sup>2</sup> C . . . . .	18
<b>7 Automatic Tuning Implementation (ATI)</b>	<b>19</b>
7.1 Automatic ATI . . . . .	19
<b>8 Electrical Specifications</b>	<b>20</b>
8.1 Absolute Maximum Specifications . . . . .	20
8.2 General Characteristics . . . . .	20
8.3 Output Characteristics . . . . .	20
8.4 Packaging Information . . . . .	21
8.4.1 DFN-6 . . . . .	21
8.4.2 MSL Level . . . . .	21
<b>9 Datasheet and Part-number Information</b>	<b>22</b>
9.1 Ordering Information . . . . .	22



9.2	Standard Devices . . . . .	22
9.3	Device Marking - Top . . . . .	23
9.3.1	DFN-6 Package Markings . . . . .	23
9.3.2	Tape and Reel Specification . . . . .	23
<b>A</b>	<b>Memory Map</b>	<b>24</b>



## List of Abbreviations

ATI	Automatic Tuning Implementation
BP	Boost Power Mode
CS	Counts (Number of Charge Transfers)
C <sub>S</sub>	Internal Reference Capacitor
DYCAL™	Dynamic Calibration
EMI	Electromagnetic Interference
ESD	Electro-Static Discharge
FTB/EFT	(Electrical) Fast Transient Bursts
GND	Ground
HC	Halt Charge
LP	Low Power Mode
LTA	Long Term Average
THR	Threshold



## 1 Overview

### 1.1 Device

The IQS227D is a single channel capacitive proximity and touch controller with an internal voltage regular and reference capacitor ( $C_S$ ).

The IQS227D device has dedicated pin(s) for the connection of sense electrodes ( $C_x$ ) and output pins for proximity events on POUT and touch event on TOUT. The output pins can be configured for various output methods including a I<sup>2</sup>C data streaming option on TOUT and POUT.

Device configuration is determined by One Time Programmable (OTP) options. The device can automatically track slow varying environmental changes via various filters and detect noise. It has an Automatic Tuning Implementation (ATI) to tune the device sense electrode(s). The IQS227D is built on ProxSense® low voltage platform ideal for battery application (down to 2.4 V).

### 1.2 Applicability

All specifications, except where specifically mentioned otherwise, provided by this datasheet are applicable to the following ranges:

- > Temperature:
  - IQS227D: -40°C to 85°C
- > Supply voltage ( $V_{DDHI}$ ): 2.4 V to 5 V

### 1.3 Analogue Functionality

The analogue circuitry measures the capacitance of a sense electrode attached to the  $C_x$  pin through a charge transfer process that is periodically initiated by the digital circuitry. The measuring process is referred to a conversion and consists of the discharging of reference capacitor and  $C_x$ , the charging of  $C_x$  and then a series of charge transfers from  $C_x$  to  $C_s$  until a trip voltage is reached. The number of charge transfers required to reach the trip voltage is referred to as the Counts (CS). The capacitance measurement circuitry makes use of an internal  $C_s$  and voltage reference (VREG). The analogue circuitry further provides functionality for:

- > Power on reset (POR) detection.
- > Reset detection.



## 2 Packaging and Pin-Out

### 2.1 IQS227D

The IQS227D is available in a DFN-6 package.

#### 2.1.1 Pin-out

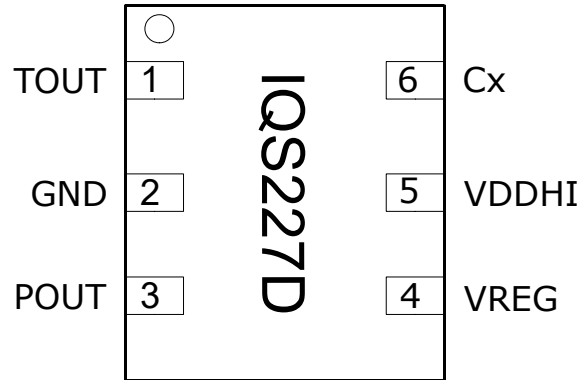

Figure 2.1: IQS227D DFN-6 Pin-out

Table 2.1: DFN-6 Pin-out Description

Pin	Name	Type	Function
1	TOUT	Digital Output	Touch Output
2	GND	Ground	GND Reference
3	POUT	Digital Output	Proximity Output
4	VREG	Analogue Output	Internal Regulator Pin
5	VDDHI	Supply Input	Supply voltage Input
6	Cx	Analogue I/O	Sense Electrode



## 2.2 Schematic

### 2.2.1 DFN-6

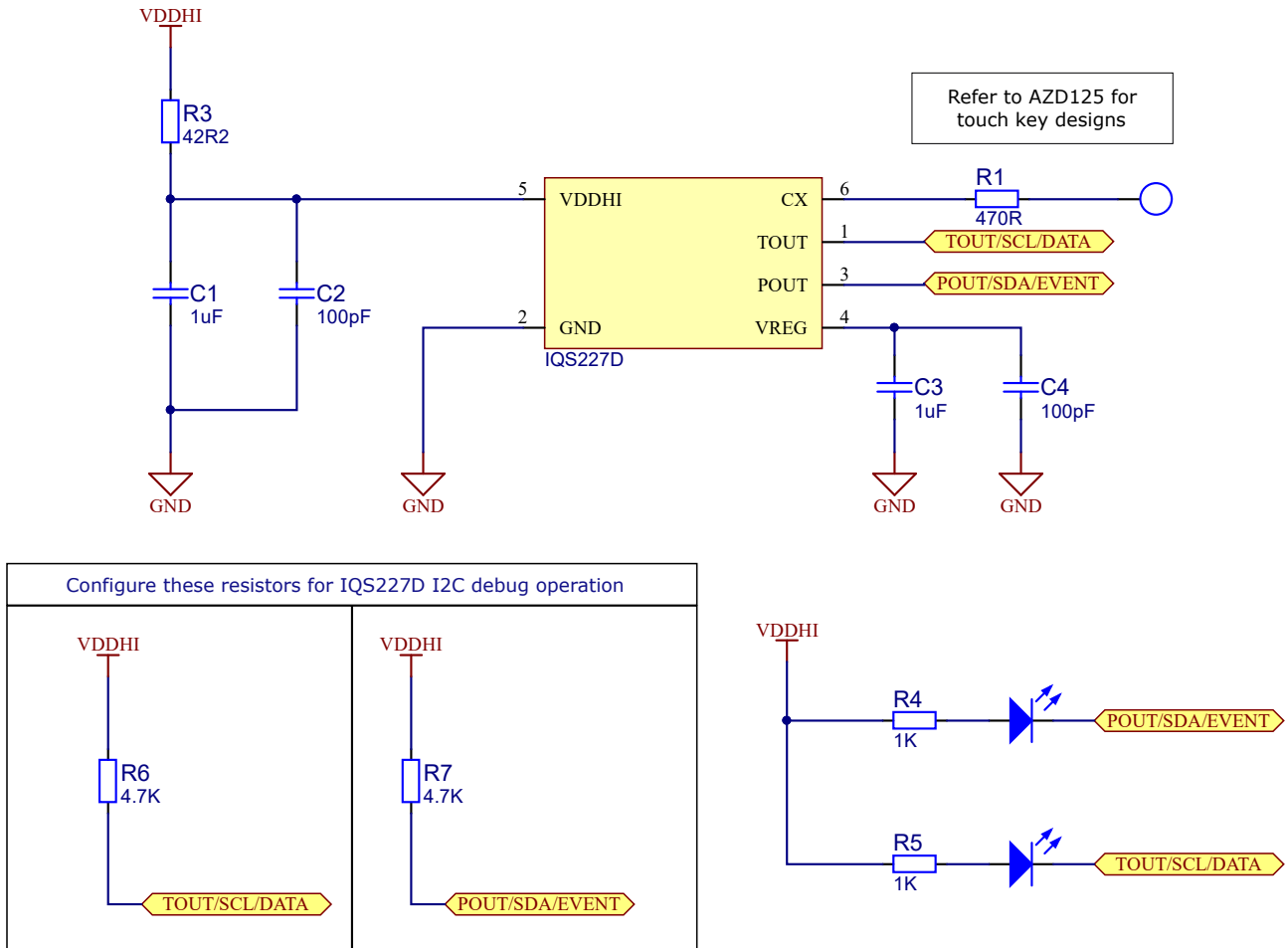

Figure 2.2: Typical application schematic of IQS227D. 100 pF capacitors are optional for added RF immunity. Place all decoupling capacitors (on VDDHI and VREG) as close to the IC as possible.

Where a system level ESD strike is found to cause the IC to go into ESD induced latch-up, it is suggested that the supply current to the IQS227D IC is limited by means of a series resistor that could limit the maximum supply current to the IC to <80 mA.

The 1uF capacitors on VDDHI and VREG are for default power mode. Please see Table 2.3 to select the correct capacitors for low power modes.

The 470 Ω series resistor on the Cx pin is added for ESD protection.

## 2.3 Recommended Capacitor Values

The 1uF VREG capacitor value is chosen to ensure VREG remains above the maximum BOD specification stated in Table 8.2. The combination of the 1 μF VREG capacitor and the 1 μF VDDHI capacitor is chosen to prevent a potential ESD issue. Recommended values to prevent this is shown in Table 2.2.



Table 2.2: VDDHI and VREG capacitor size recommendation to prevent ESD issues with typical hardware combinations

Low Power Scan	8ms(default) - 32ms	64ms	128ms	160ms
Capacitor	C1 = 1 $\mu$ F	C1 = 4.7 $\mu$ F	C1 = 4.7 $\mu$ F	C1 = 4.7 $\mu$ F
recommendation	C3 = 1 $\mu$ F	C3 = 2.2 $\mu$ F	C3 = 2.2 $\mu$ F	C3 = 2.2 $\mu$ F

## 2.4 Exception to recommended capacitor values

In applications where the VDDHI source has high internal resistance or a high resistance path, it will be required to ensure  $C3 > C1$  to prevent a VDDHI BOD after the IC sleep cycle (see Table 8.2).

Table 2.3: Capacitor Values for VDDHI and VREG under certain supply voltage condition

Low Power Scan	8ms(default) - 32ms	64ms	128ms	160ms
Capacitor	C1 = 1 $\mu$ F	C1 = 2.2 $\mu$ F	C1 = 4.7 $\mu$ F	C1 = 4.7 $\mu$ F
recommendation	C3 = 1 $\mu$ F	C3 = 4.7 $\mu$ F	C3 = 10 $\mu$ F	C3 = 10 $\mu$ F





### 3 User Configurable Options

The IQS227D provides One Time Programmable (OTP) user options (each option can be modified only once). The device is fully functional in the default state. OTP options are intended for specific applications. The configuration of the device can be done on packaged devices or in-circuit. In-circuit configuration may be limited by values of external components chosen. A number of standard device configurations are available. Azoteq can supply pre-configured devices for large quantities.

#### 3.1 Configuring of Devices

Azoteq offers a Configuration Tool (CT210) and accompanying software (USBProg2.exe) that can be used to program the OTP user options for prototyping purposes.

Alternative programming solutions for the IQS227D also exist. For further enquiries regarding this, please contact Azoteq at [ProxSenseSupport@azoteq.com](mailto:ProxSenseSupport@azoteq.com) or the local distributor.

*Table 3.1: User Selectable Configuration Options: Bank 0 (0xC4H) – IQS227D000000xxDNR*

Bit 7	Bit 6	Bit 5	Bit 4	Bit 3	Bit 2	Bit 1	Bit 0
T <sub>Func</sub>	P <sub>Func</sub>	LOGIC	T <sub>THR2</sub>	T <sub>THR1</sub>	T <sub>THR0</sub>	P <sub>THR1</sub>	P <sub>THR0</sub>
<b>Bit 7</b>	<b>T<sub>Func</sub></b> : Touch Function						Section <a href="#">5.3</a>
	0 = Normal						
	1 = Toggle						
<b>Bit 6</b>	<b>P<sub>Func</sub></b> : Proximity Function						Section <a href="#">5.3</a>
	0 = Normal						
	1 = Latch						
<b>Bit 5</b>	<b>LOGIC</b> : I/O's Output logic select						Section <a href="#">5.2</a>
	0 = Active low						
	1 = Active High						
<b>Bit 4-2</b>	<b>T<sub>THR</sub></b> : Touch Threshold						Section <a href="#">5.5</a>
	000 = 72/256						
	001 = 8/256						
	010 = 24/256						
	011 = 48/256						
	100 = 96/256						
	101 = 128/256						
	110 = 160/256						
	111 = 192/256						
<b>Bit 1-0</b>	<b>P<sub>THR</sub></b> : Proximity Threshold Selections						Section <a href="#">5.4</a>
	00 = 4						
	01 = 2						
	10 = 8						
	11 = 16						



Table 3.2: User Selectable Configuration Options: Bank 1 Full ATI (0xC5H) – IQS227D0000xx00DNR

Bit 7	Bit 6	Bit 5	Bit 4	Bit 3	Bit 2	Bit 1	Bit 0
t <sub>HALT1</sub>	t <sub>HALT0</sub>	~	~	~	BASE <sub>2</sub>	BASE <sub>1</sub>	BASE <sub>0</sub>

- Bit 7-6** **t<sub>HALT</sub>**: Halt times Section [5.10](#)  
 00 = 20 seconds  
 01 = 40 seconds  
 10 = Never  
 11 = Always (Prox on 40s)
- Bit 5-3** **Reserved**
- Bit 2-0** **BASE**: Base Value Section [5.7](#)  
 000 = 200  
 001 = 50  
 010 = 75  
 011 = 100  
 100 = 150  
 101 = 250  
 110 = 300  
 111 = 500

Table 3.3: User Selectable Configuration Options: Bank 2 (0xC6H) – IQS227D00xx0000DNR

Bit 7	Bit 6	Bit 5	Bit 4	Bit 3	Bit 2	Bit 1	Bit 0
STREAM	TRANS	COMMS	~	TARGET	~	LP <sub>1</sub>	LP <sub>0</sub>

- Bit 7** **STREAM**: Streaming Method Section [6.1](#)  
 0 = Standalone  
 1 = 2-wire (I<sup>2</sup>C)
- Bit 6** **TRANS**: Charge Transfer Frequency Section [5.8](#)  
 0 = 512 kHz  
 1 = 250 kHz
- Bit 5** **COMMS**: Streaming Section [6](#)  
 0 = Disabled  
 1 = Enabled
- Bit 4** **Reserved**
- Bit 3** **TARGET**: ATI Target Counts Section [5.9](#)  
 0 = 1024  
 1 = 512
- Bit 2** **Reserved**
- Bit 1-0** **LP**: Low Power Modes Section [5.6](#)  
 00 = BP (9 ms)  
 01 = NP (128 ms)  
 10 = LP1 (256 ms)  
 11 = LP2 (512 ms)



## 4 Measuring Capacitance Using the *Charge Transfer Method*

The charge transfer method of capacitive sensing is employed on the IQS227D. (The charge transfer principle is thoroughly described in the application note: [AZD004 - Azoteq Capacitive Sensing](#)).

A charge cycle is used to take a measurement of the capacitance of the sense electrode (connected to Cx) relative to ground. It consists of a series of pulses charging Cx and discharging Cx to the reference capacitor, at the charge transfer frequency ( $f_{Cx}$  - refer to Section 5.9 and 8.2). The number of the pulses required to reach a trip voltage on the reference capacitor is referred to as Count Value (CS) which is the instantaneous capacitive measurement. The Counts (CS) are used to determine if either a physical contact or proximity event occurred (refer to Section 5.10.1), based on the change in Counts (CS) detected. The typical values of CS, without a touch or proximity condition range between 650 and 1150 Counts, although higher and lower counts can be used based on the application requirements. With counts larger than +/-1150 the gain of the system may become too high causing unsteady operation.

The IQS227D schedules a charge cycle every  $t_{SAMPLE}$  seconds to ensure regular samples for processing of results. The duration of the charge cycle is defined as  $t_{CHARGE}$  (refer to Section 5.6, and varies according to the counts required to reach the trip voltage. Following the charge cycle other activities such as data streaming is completed (if in streaming mode), before the next charge cycle is initiated.

**Please note: Attaching a probe to the Cx pin will increase the capacitance of the sense plate and therefore Cs. This may have an immediate influence on the counts (decrease  $t_{CHARGE}$ ) and cause a proximity or touch event.**

After  $t_{HALT}$  seconds the system will adjust to accommodate for this change. If the total load on Cx, with the probe attached is still lower than the maximum Cx load the system will continue to function normally after  $t_{HALT}$  seconds with the probe attached.

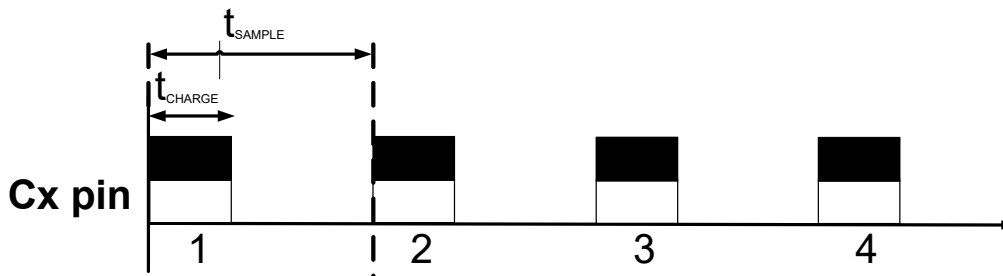

Figure 4.1: Charge cycles as can be seen on Cx.



## 5 Descriptions of User Options

This section describes the individual user programmable options of the IQS227D in more detail.

User programmable options are programmed to One Time Programmable (OTP) fuse registers (refer to Section 3).

### Note:

- > HIGH=Logical '1' and LOW=Logical '0'.
- > The following sections are explained with POUT and TOUT taken as 'Active LOW'.
- > The default is always where bits are set to 0.

Refer to Section 8.3 for the sourcing and sinking capabilities POUT and TOUT. These pins are sourced from VDDHI and will be turned HIGH (when active high) for a minimum time of  $t_{HIGH}$ , and LOW for a minimum time of  $t_{LOW}$  (when active low).

### 5.1 Proximity / Touch Sensor

The IQS227D provides a Proximity output on POUT and a Touch output on TOUT, and does not need to be configured.

### 5.2 Logic select for outputs

The logic used by the device can be selected as active HIGH or active LOW. The output pins, POUT and TOUT, will function based on this selection. The I/O's are push-pull in both directions and does not require a pull-up resistor. When configured as Active High, the I/O's will remain high at POR until ATI has been completed. ATI times will vary based on the capacitive load on the sensor, but typically do not exceed 500 ms.

Configuration: [Bank 0 Bit 5](#)

#### LOGIC: Output Logic Select

Bit	Selection
0	Active Low
1	Active High

### 5.3 Output Pin Function

Various options for the function of the output pin(s) are available. These are selected as follows:

Configuration: [Bank 0 Bit 7-6](#)

#### FUNC1:FUNC0 OUTPUT Pins' functions

Bit	Selection
00	POUT active, TOUT active
01	POUT latch, TOUT active
10	POUT active, TOUT toggle
11	POUT latch, TOUT toggle



### 5.3.1 Output function: Active

With a Proximity or Touch event, the output pin will change to LOW and stay LOW for as long as the event remains (see Figure 5.1). Also refer to the use of  $t_{\text{HALT}}$  Section 5.10.1 that may cause the termination of the event.

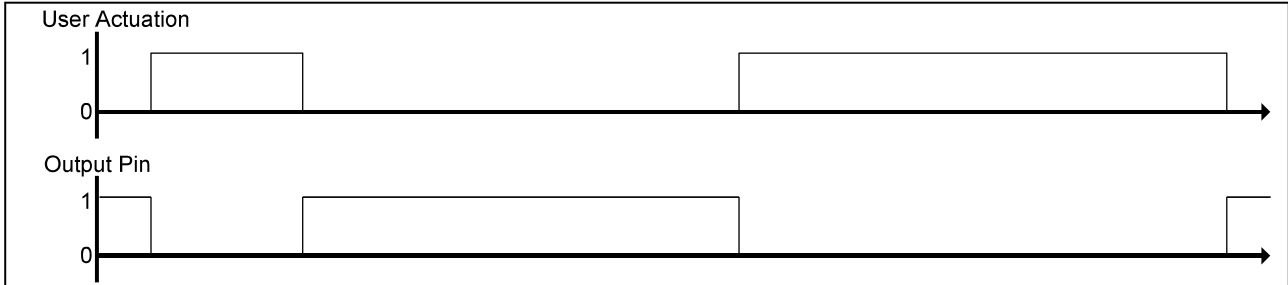

Figure 5.1: Active Mode Output Configuration

### 5.3.2 Output function: Latch (for $t_{\text{LATCH}}$ )

With a Proximity or Touch event, the output pin will latch LOW for  $t_{\text{LATCH}}$  seconds (4 seconds). When the event terminates prior to  $t_{\text{LATCH}}$  the output pin will remain LOW. When the event remains active longer than  $t_{\text{LATCH}}$  the output pin will remain LOW as long as the event remains active (see Figure 5.2). When a subsequent event is made before the latch time (4 seconds) has passed, the timer will reset and the output will remain low for another duration of  $t_{\text{LATCH}}$  seconds (4 seconds). For more details see Figure 5.2.

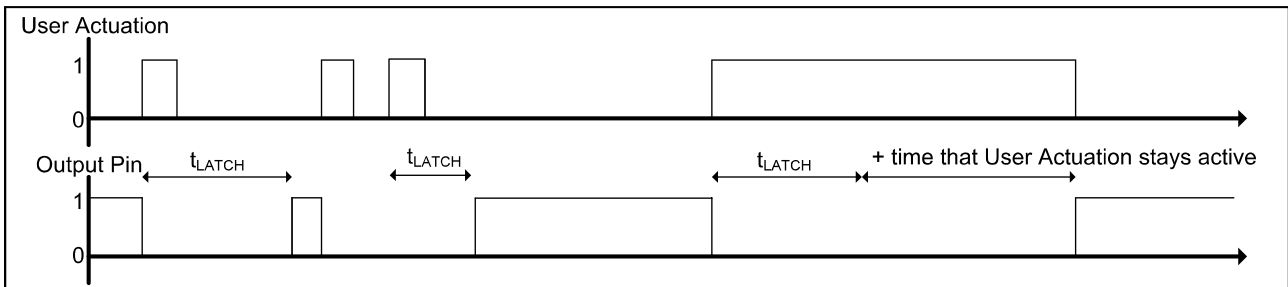

Figure 5.2: Latch Mode Output Configuration

### 5.3.3 Output function: Toggle

The output pin will toggle with every Proximity or Touch event occurring. Thus, when an event occurs and the output is LOW the output will become HIGH and when the output is HIGH the output will become LOW (see Figure 5.3)

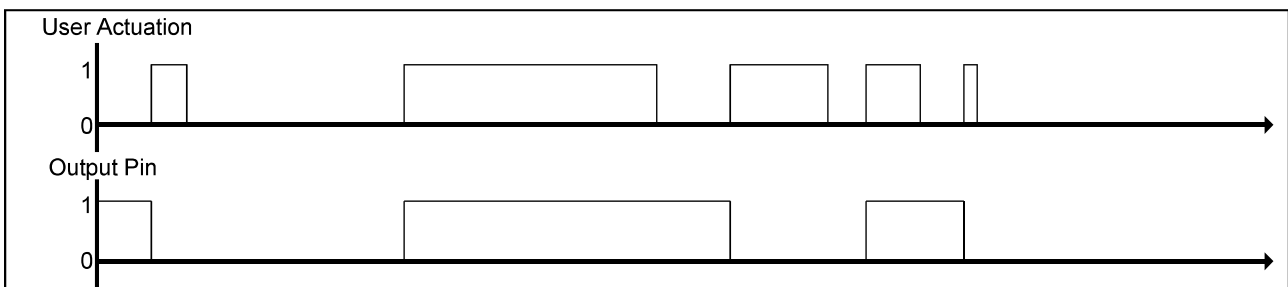

Figure 5.3: Toggle Mode Output Configuration



## 5.4 Proximity Threshold

The IQS227D has 4 proximity threshold settings. The proximity threshold is selected by the designer to obtain the desired sensitivity and noise immunity. The proximity event is triggered based on the selected proximity threshold; the Counts (CS) and the LTA (Long Term Average). The threshold is expressed in terms of counts; the same as CS (refer to Section 4). A proximity event is identified when for at least 6 consecutive samples the following equation holds:

$$P_{THR} = < LTA - CS \tag{1}$$

Where LTA is the Long Term Average (refer to Section 5.10.1)

Configuration: *Bank 0 Bit 1-0*

P <sub>THR1</sub> :P <sub>THR0</sub> OUTPUT Pins' functions	
Bit	Selection
00	4
01	2 (Most sensitive)
10	8
11	16 (Least sensitive)

## 5.5 Touch Threshold

The IQS227D has 8 touch threshold settings. The touch threshold is selected by the designer to obtain the desired touch sensitivity. The touch threshold is expressed as a fraction of the LTA as follows:

$$T_{THR} = \frac{x}{256} * LTA \tag{2}$$

The touch event is triggered based on T<sub>TH</sub>, Counts (CS) and LTA. A touch event is identified when for at least 3 consecutive samples the following equation holds:

$$T_{THR} = < LTA - CS \tag{3}$$

With lower average counts (therefore lower LTA) values the touch threshold will be lower and vice versa.



Configuration: *Bank 0 Bit 4-2*

T <sub>THR2</sub> :T <sub>THR0</sub> : Touch Thresholds		
Bit	Selection	
000	72/256	
001	8/256	(Most sensitive)
010	24/256	
011	48/256	
100	96/256	
101	128/256	
110	160/256	
111	192/256	(Least sensitive)

### 5.6 Power Modes

The IQS227D has four power modes specifically designed to reduce current consumption for battery applications. The power modes are basically implemented around the occurrence of charge cycle every  $t_{SAMPLE}$  seconds (refer to Table 5.1). The fewer charge transfer cycles that need to occur per second the lower the power consumption (but decreased response time). During Boost Power Mode (BP), charge cycles are initiated approximately every 9 ms. While in any power mode the device will zoom to BP whenever an existing count sample (CS) indicates a possible proximity or touch event. The device will remain in BP for  $t_{ZOOM}$  seconds and then return to the selected power mode. The Zoom function allows reliable detection of events with counts being produced at the BP rate.

Table 5.1: Power Mode configuration: Bank 2 bit 1-0

Bit	Power Mode Timing	$t_{SAMPLE}(ms)$
00	$t_{BP}$ (default)	BP (9 ms)
01	$t_{NP}$	128
10	$t_{LP1}$	256
11	$t_{LP2}$	512

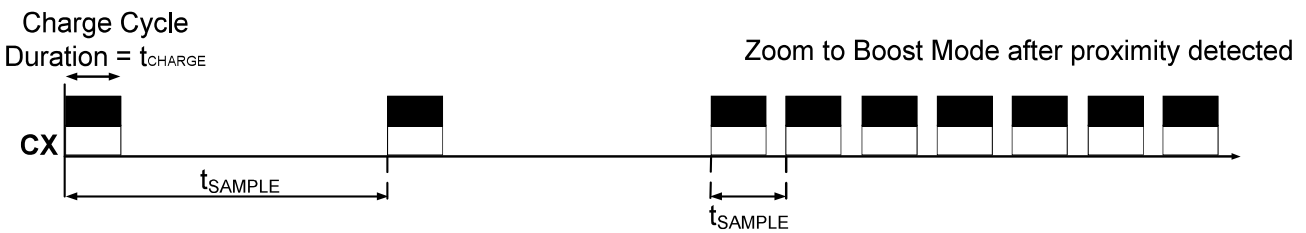

Figure 5.4: Active Mode Output Configuration

### 5.7 Base Values

The sensitivity of the IQS227D can be changed by adjusting the target and base values of the ATI algorithm, and as a result changing the compensation required to reach the set target. See Section 3.1 for the OTP selectable options of BASE (Table 3.2).

$$sensitivity = \frac{TARGET}{BASE} \quad (4)$$



Configuration: [Bank 1 Bit 2-0](#)

BASE : Base Value Select	
Bit	Selection
000	200
001	50
010	75
011	100
100	150
101	250
110	300
111	500

## 5.8 ATI Target Counts

The target of the ATI algorithm can be adjusted between 1024 (default) and 512 counts. When less sensitivity is required, the lower counts will also increase response rate. See Section [3.1](#) for the OTP selectable options of TARGET (Table [3.3](#)).

Configuration: [Bank 2 Bit 3](#)

TARGET : ATI Target Counts	
Bit	Selection
0	1024
1	512

## 5.9 Charge Transfer

The charge transfer frequency of the IQS227D is adjustable. Changing the transfer frequency will affect sensitivity and response rate. Two options are available:

Configuration: [Bank 2 Bit 6](#)

TRANS : Charge Transfer Frequency	
Bit	Selection
0	512 kHz
1	250 kHz

## 5.10 Filters used by the IQS227D

The IQS227D devices employ various signal processing functions that includes the execution of various filters as described below.

### 5.10.1 Long Term Average (LTA)

Capacitive touch devices detect changes in capacitance that are not always related to the intended proximity or touch of a human. This is a result of changes in the environment of the sense plate and other factors. These changes need to be compensated for in various manners in order to reliably detect touch events and especially to detect proximity events. One mechanism the IQS227D employs is the use of a Long Term Averaging filter (IIR type filter) which tracks slow changes in the environment (expressed as changes in the counts). The result of this filter is a Long Term Average (LTA) value that





forms a dynamic reference used for various functions such as identification of proximity and touch events.

The LTA is calculated from the counts (CS). The filter only executes while no proximity or touch event is detected to ensure compensation only for environmental changes. However, there may be instances where sudden changes in the environment or changes in the environment while a proximity or touch event has been detected cause the counts to drift away from the LTA. To compensate for these situations a Halt Timer ( $t_{\text{HALT}}$ ) has been defined. The Halt Timer is started when a proximity or touch event occurs and when it expires the LTA filter is recalibrated. Recalibration causes  $LTA < CS$ , thus the disappearance of proximity or touch events (refer to Sections 5.4 and 5.5). The designer needs to select a Halt Timer value to best accommodate the required application.

**Configuration:** *Bank 1 Bit 7-6*

$t_{\text{HALT1}}$ : $t_{\text{HALT0}}$ OUTPUT Pins' functions	
Bit	Selection
00	20 seconds
01	40 seconds
10	NEVER
11	ALWAYS (Proximity on 40 seconds)

Notes:

- > The “NEVER” option indicates that the execution of the filters will never be halted.
- > With the ‘ALWAYS’ option and the detection of a proximity event the execution of the filter will be halted for only 40 seconds and with the detection of a touch event the execution of the filter will be halted as long as the touch condition applies.

Refer to Application note [AZD004 - Azoteq Capacitive Sensing](#) for detail regarding the execution of the LTA filter.

### 5.10.2 IIR Raw Data filter

The extreme sensitivity of the IQS227D makes it susceptible to external noise sources. This causes a decreased signal to noise (S/N) ratio, which could potentially cause false event detections. Noise can also couple into the device as a result of poor PCB, sense electrode design and other factors influencing capacitive sensing devices. In order to compensate for noise the IQS227D uses an IIR filter on the raw data to minimize result of noise in the counts. This filter is implemented on all the IQS227D devices, and cannot be disabled.



## 6 Data Streaming Mode

The IQS227D has the capability to stream data to an MCU. This provides the designer with the capability to obtain the parameters within the device in order to aid design into applications. Data streaming may further be used by an MCU to control events or further process results obtained from the IQS227D devices. Data streaming is performed through I<sup>2</sup>C communication (SDA on POUT, SCL on TOUT). Data Streaming can be enabled as indicated below:

Configuration: [Bank 2 Bit 7](#)

### COMMS: Data Streaming

Bit	Selection
-----	-----------

0	Disabled
---	----------

1	Enabled
---	---------

Configuration: [Bank 2 Bit 5](#)

### STREAMING: Data Streaming Mode

Bit	Selection
-----	-----------

0	Standalone
---	------------

1	I <sup>2</sup> C
---	------------------

Data streaming is initiated by the IQS227D. When data streaming is enabled data is sent following each charge.

### 6.1 I<sup>2</sup>C

The IQS227D also allow for I<sup>2</sup>C streaming for debugging. Data Streaming can be changed to I<sup>2</sup>C as shown below:

Configuration: [Bank 2 Bit 7](#)

### STREAMING: Data Streaming Mode

Bit	Selection
-----	-----------

0	Standalone
---	------------

1	I <sup>2</sup> C
---	------------------

The Memory Map for the IQS227D can be found in Appendix A. The IQS227D can communicate on an I<sup>2</sup>C compatible bus structure. Note that 4.7 k $\Omega$  pull-up resistors should be placed on SDA and SCL. The Control byte indicates the 7-bit device address (0x44H) and the Read/Write indicator bit.



## 7 Automatic Tuning Implementation (ATI)

ATI is sophisticated technology implemented in the latest generation ProxSense® devices that optimises the performance of the sensor in a wide range of applications and environmental conditions (refer to application note [AZD004](#)).

ATI makes adjustments through external reference capacitors unnecessary (as required by most other solutions) to obtain optimum performance.

ATI adjusts internal circuitry according to two parameters, the ATI multiplier and the ATI compensation. The ATI multiplier can be viewed as a course adjustment and the ATI compensation as a fine adjustment. The adjustment of the ATI parameters will result in variations in the counts and sensitivity. Sensitivity can be observed as the change in current sample as the result of a fixed change in sensed capacitance. The ATI parameters have been chosen to provide significant overlap. It may therefore be possible to select various combinations of ATI multiplier and ATI compensation settings to obtain the same count value. The sensitivity of the various options may however be different for the same count value.

### 7.1 Automatic ATI

The IQS227D implements an automatic ATI algorithm. This algorithm automatically adjusts the ATI parameters to optimise the sensing electrodes connection to the device. The device will execute the ATI algorithm whenever the device starts-up and when the counts are not within a predetermined range. While the Automatic ATI algorithm is in progress this condition will be indicated in the streaming data and proximity and touch events cannot be detected. The device will only briefly remain in this condition, and it will be entered only when relatively large shifts in the counts has been detected. The automatic ATI function aims to maintain a constant count value, regardless of the capacitance of the sense electrode (within the maximum range of the device). The effects of auto-ATI on the application are the following:

- > Automatic adjustment of the device configuration and processing parameters for a wide range of PCB and application designs to maintain an optimal configuration for proximity and touch detection.
- > Automatic tuning of the sense electrode at start-up to optimise the sensitivity of the application.
- > Automatic re-tuning when the device detects changes in the sensing electrodes capacitance to accommodate a large range of changes in the environment of the application that influences the sensing electrode.
- > Re-tuning only occurs during device operation when a relatively large sensitivity reduction is detected. This is to ensure smooth operation of the device during operation.
- > Re-tuning may temporarily influence the normal functioning of the device, but in most instances the effect will be hardly noticeable.
- > Shortly after the completion of the re-tuning process the sensitivity of a Proximity detection may be reduced slightly for a few seconds as internal filters stabilises.

Automatic ATI can be implemented so effectively due to:

- > Excellent system signal to noise ratio (SNR).
- > Effective digital signal processing to remove AC and other noise.
- > The very stable core of the devices.
- > Built in capability to accommodate a large range of sensing electrode capacitances.



## 8 Electrical Specifications

### 8.1 Absolute Maximum Specifications

**Exceeding these maximum specifications may cause damage to the device**

Operating temperature:	-40°C to 85°C
Supply Voltage ( $V_{DDHI}-V_{SS}$ )	5.5V
Maximum pin Voltage ( $T_{OUT}, P_{OUT}$ )	$V_{DDHI} + 0.3V$
Minimum pin voltage ( $V_{DDHI}, V_{REG}, T_{OUT}, P_{OUT}, C_X$ )	$V_{SS} - 0.3V$
Minimum power-on slope	100V/s
ESD protection ( $V_{DDHI}, V_{REG}, V_{SS}, T_{OUT}, P_{OUT}, C_X$ )	8kV

### 8.2 General Characteristics

IQS227D devices are rated for supply voltages between 2.4 V and 5 V.

*Table 8.1: IQS227D General Operating Conditions*

Description	Conditions	Parameter	Min	Typ	Max	Unit
Supply voltage		$V_{DDHI}$	2.4	~	5	V
Internal regulator output	$2.4 \leq V_{DDHI} \leq 5.0$	$V_{REG}$	1.98	~	2.08	V
Boost operating current	$2.4 \leq V_{DDHI} \leq 5.0$	$I_{IQS227D\_BP}$	~	101	~	$\mu A$
Normal operating current	$2.4 \leq V_{DDHI} \leq 5.0$	$I_{IQS227D\_NP}$	~	6	~	$\mu A$
Low Power 1 operating current	$2.4 \leq V_{DDHI} \leq 5.0$	$I_{IQS227D\_LP1}$	~	4.5	~	$\mu A$
Low Power 2 operating current	$2.4 \leq V_{DDHI} \leq 5.0$	$I_{IQS227D\_LP2}$	~	<3.2	~	$\mu A$
Charge transfer frequency range	$2.4 \leq V_{DDHI} \leq 5.0$	$f_{C_X} = 512/250$	-8%	$f_{C_X}$	+8%	kHz

Charge Transfer Timings for low power modes are found in section 5.6.

*Table 8.2: Start-up and shut-down slope Characteristics*

Description	Parameter	Min	Max	Unit
Reset release voltage on $V_{DDHI}$ rising edge	$V_{DDHI}$ Reset Rising Edge (POR)	~	2.1	V
Reset trigger voltage on $V_{DDHI}$ falling edge	$V_{DDHI}$ Reset Falling Edge (BOD)	0.3	~	V
Reset release voltage on $V_{REG}$ rising edge	$V_{REG}$ Reset Rising Edge (POR)	~	1.8	V
Reset trigger voltage on $V_{REG}$ falling edge	$V_{REG}$ Reset Falling Edge (BOD)	0.3	~	V

### 8.3 Output Characteristics

*Table 8.3: Digital I/O Characteristics*

Parameter	Test Conditions	Min	Typ	Max	Unit
$V_{OL}$	$T_{OUT}$ and $P_{OUT}$ Output low voltage $I_{sink} = 10\text{ mA}$	~	~	0.3	V
$V_{OH}$	Output high voltage $I_{source} = 5\text{ mA}$	$V_{DD} - 0.3$	~	~	V
$V_{IL}$	Input low voltage	~	~	$0.3 \times V_{DD}$	V
$V_{IH}$	Input high voltage	$0.7 \times V_{DD}$	~	~	V

## 8.4 Packaging Information

### 8.4.1 DFN-6

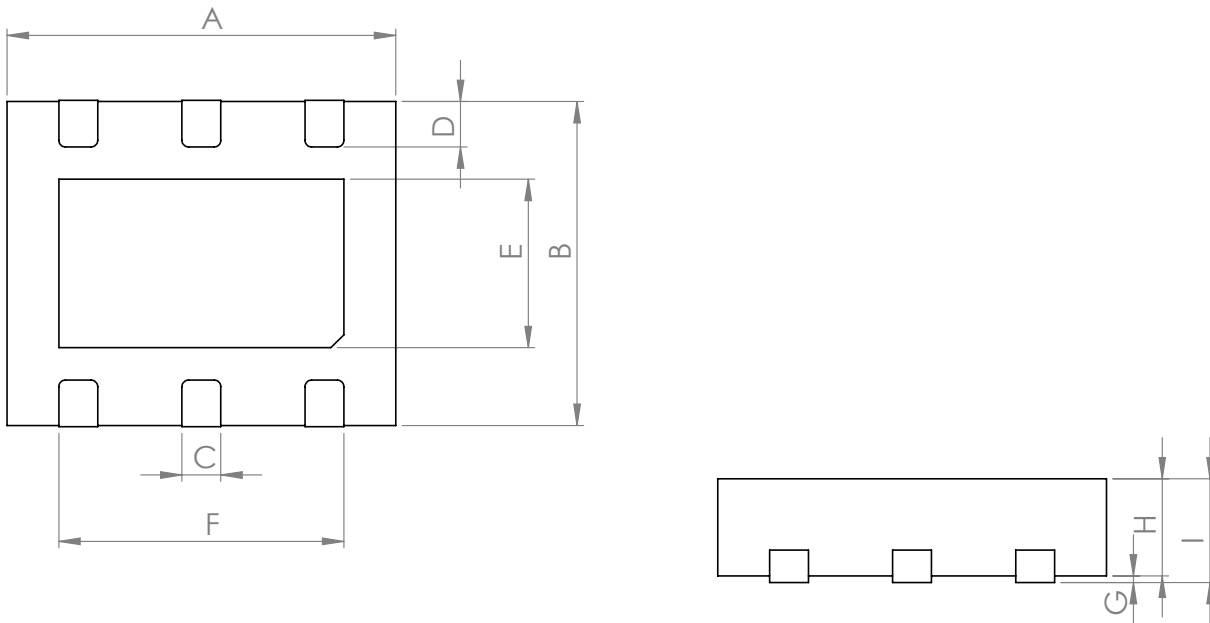

Figure 8.1: DFN-6 Packaging

Table 8.4: DFN-6 Dimensions

Dimension	Min (mm)	Max (mm)
A	3.00	3.00
B	2.50	2.50
C	0.30	0.30
D	0.35	0.35
E	1.30	1.30
F	2.20	2.20
G	0.05	0.05
H	0.75	0.75
I	0.80	0.80

### 8.4.2 MSL Level

**Moisture Sensitivity Level (MSL)** relates to the packaging and handling precautions for some semiconductors. The MSL is an electronic standard for the time period in which a moisture sensitive device can be exposed to ambient room conditions (approximately 30°C/85% RH see J-STD003C for more information) before reflow occurs.

Package	Level (duration)
DFN-6	MSL 1 (Unlimited at $\leq 30^{\circ}\text{C}/85\% \text{RH}$ ) Reflow profile peak temperature $< 260^{\circ}\text{C}$ for $< 30$ seconds



## 9 Datasheet and Part-number Information

### 9.1 Ordering Information

Contact the official distributor for sample quantities. A list of the distributors can be found under the "Distributors" section of [www.azoteq.com](http://www.azoteq.com). Special MOQs apply for custom configurations.

The Part-number can be generated by using USBProg2.exe.

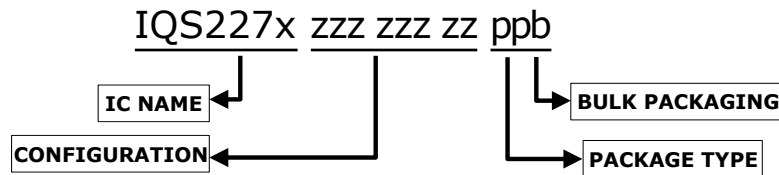

<b>IC NAME</b>	IQS227D	=	Self Capacitive IC with Dual Outputs
<b>CONFIGURATION</b>	zzz zzz zz	=	IC Configuration (hexadecimal)
<b>PACKAGE TYPE</b>	DN	=	DFN-6 package
<b>BULK Packaging</b>	R	=	Reel (6000pcs/reel) – MOQ = 6000pcs MOQ = 1 reel. (Orders shipped as full reels)

### 9.2 Standard Devices

The default (unconfigured) device will be suitable for most applications. Some popular configurations are kept in stock and do not require further programming. (Ordering codes given for Device IDs: 03 0D / 03 0E or later (the Device ID will be read in USBProg2.exe)).

*Table 9.1: IQS127D Standard Replacements*

Device	Function
IQS227D-00400008DNR	Default
IQS227D-00400028DNR	Active HIGH outputs
IQS227D-00410008DNR	Normal Power Mode
IQS227D-00400088DNR	Touch Output ac Toggle

### 9.3 Device Marking - Top

#### 9.3.1 DFN-6 Package Markings

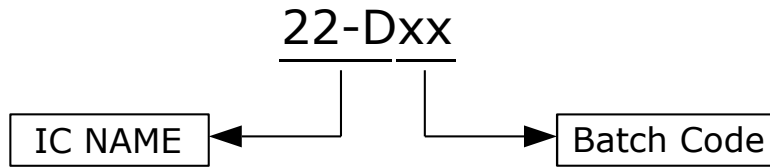

Figure 9.1: Top Marking of IQS227D

<b>IC NAME</b>	22-D	=	IQS227D Self Capacitive
<b>Batch Code</b>	xx	=	AA to ZZ

#### 9.3.2 Tape and Reel Specification

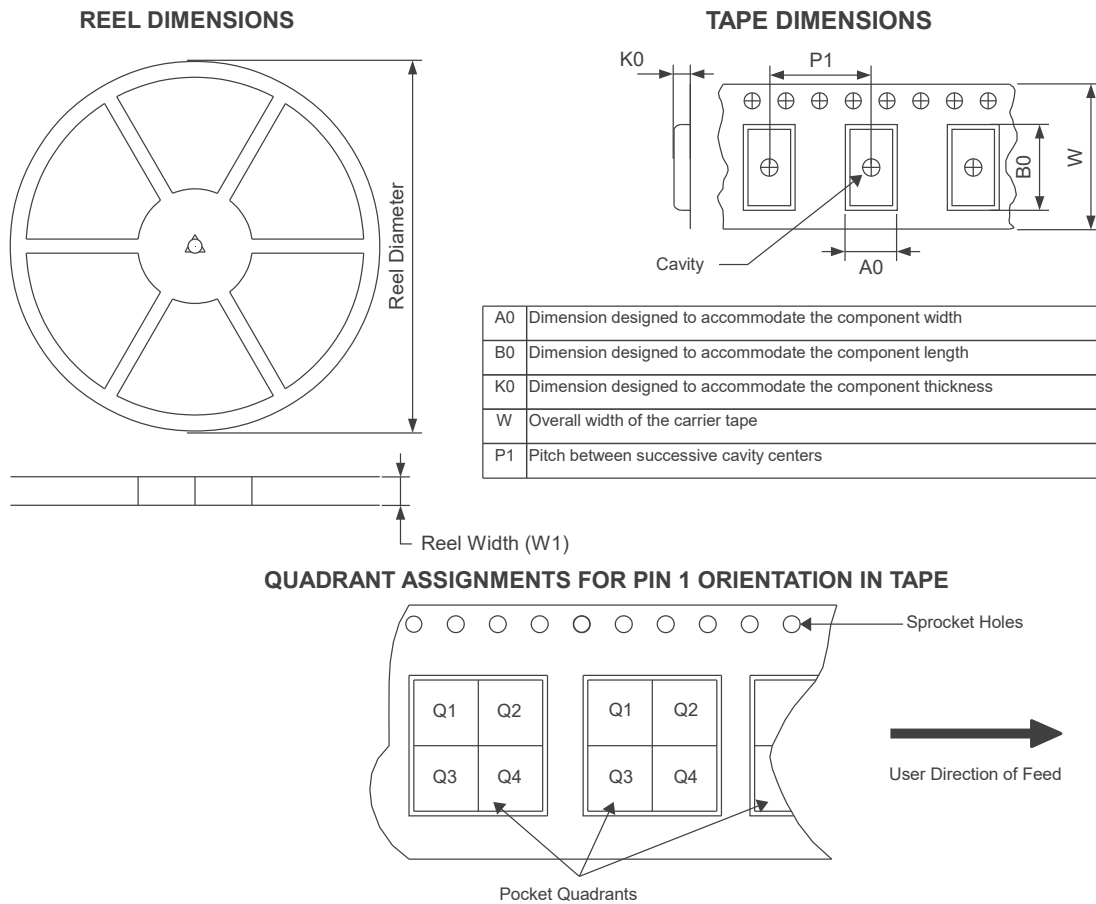

Figure 9.2: DFN-6 Tape Specification

Table 9.2: Tape and Reel Dimensions

Device	Package Type	Package Drawing	Pins	QTY per reel	Reel Diameter (mm)	Reel Width W1 (mm)	A0 (mm)	B0 (mm)	K0 (mm)	P1 (mm)	W (mm)	Pin1 Quadrant
IQS227DzzzzzzzzDNR	DFN6	DFN-6	6	6000	330	12	2.8	3.3	1.2	4	12	Q1



## A Memory Map

### Device Information

00H	<b>Product Number (PROD_NR)</b>								
	Bit	7	6	5	4	3	2	1	0
	Access								
	<b>R</b>	Value							
									39 (Decimal)
	Note								

01H	<b>Software Number (SW_NR)</b>								
	Bit	7	6	5	4	3	2	1	0
	Access								
	<b>R</b>	Value							
									28 (Decimal)
	Note								

#### [00H] PROD\_NR

The product number for the IQS227D is 39 (Decimal).

#### [01H] SW\_NR

The software version number of the device ROM can be read in this byte. The latest software version is 28 (Decimal).

10H	<b>System Flags (Sys_Flags)</b>								
	Bit	7	6	5	4	3	2	1	0
	Access								
	<b>R</b>	Value							
		~	~	Logic	Halt	LP	ATI	~	Zoom
	Note								

#### [10H] SYSFLAGS0

- Bit 7-6:**            **Reserved**
- Bit 5:**            **Logic:** Logic Output Indication.  
0 = Active Low  
1 = Active High
- Bit 4:**            **Halt:** Indicates Filter Halt Status.  
0 = LTA not being Halted  
1 = LTA Halted
- Bit 3:**            **LP:** Low Power Mode  
0 = Sample time BP





- 1 = Sample time LP
- Bit 2:** **ATI:** Status of automated ATI routine.  
0 = ATI is not busy  
1 = ATI in progress
- Bit 1:** **Reserved**
- Bit 0:** **Zoom:** Zoom will indicate full-speed charging once an undebounced proximity is detected. In BP mode, this will not change the charging frequency.  
0 = IC not zoomed in  
1 = IC detected undebounced proximity and IC is charging at full speed (BP)

<b>31H</b>	<b>Status</b>								
	Bit	7	6	5	4	3	2	1	0
	Value	~	~	~	~	~	~	Touch	Prox
Access									
<b>R</b>	Note								

**[31H] Status**

- Bit 7-2:** **Reserved**
- Bit 1:** **Touch:** Touch Detection.  
0 = Not Active  
1 = Active
- Bit 0:** **Prox:** Proximity Detection.  
0 = Not Active  
1 = Active

<b>42H</b>	<b>Counts_High (CS_H)</b>								
	Bit	7	6	5	4	3	2	1	0
	Value	Counts High Byte							
Access									
<b>R</b>	Note								



43H

**Counts\_Low (CS\_L)**

Bit	7	6	5	4	3	2	1	0
Value	Counts Low Byte							
Note								

Access

R

83H

**LTA\_High (LTA\_H)**

Bit	7	6	5	4	3	2	1	0
Value	Long Term Average High Byte							
Note								

Access

R

84H

**LTA\_Low (LTA\_L)**

Bit	7	6	5	4	3	2	1	0
Value	Long Term Average Low Byte							
Note								

Access

R

C4H

**Fuse Bank 0 (FB\_0)**

Bit	7	6	5	4	3	2	1	0
Value	See Table 3.1 for more details							
Note								

Access

R

C5H

**Fuse Bank 1 (FB\_1)**

Bit	7	6	5	4	3	2	1	0
Value	See Table 3.2 for more details							
Note								

Access

R

C6H

**Fuse Bank 2 (FB\_2)**

Bit	7	6	5	4	3	2	1	0
Value	See Table 3.3 for more details							
Note								

Access

R

C7H

**Fuse Bank 3 (FB\_3)**

Bit	7	6	5	4	3	2	1	0
Value	Not Used							
Note								

Access

R



C8H

DEFAULT\_COMMS\_POINTER

Bit	7	6	5	4	3	2	1	0
Access	Value (Beginning of Device Specific Data)							
R/W	Default 10H							

### [C8H] Default Comms Pointer

The value stored in this register will be loaded into the Comms Pointer at the start of a communication window. For example, if the design only requires the Proximity Status information each cycle, then the Default Comms Pointer can be set to **ADDRESS 31H**. This would mean that at the start of each communication window, the comms pointer would already be set to the Proximity Status register, simply allowing a **READ** to retrieve the data, without the need of setting up the address.



## Contact Information

	USA	Asia	South Africa
<b>Physical Address</b>	11940 Jollyville Suite 120-S Austin TX 78759 USA	Room 501A, Block A T-Share International Centre Taoyuan Road, Nanshan District Shenzhen, Guangdong, PRC	1 Bergsig Avenue Paarl 7646 South Africa
<b>Postal Address</b>	11940 Jollyville Suite 120-S Austin TX 78759 USA	Room 501A, Block A T-Share International Centre Taoyuan Road, Nanshan District Shenzhen, Guangdong, PRC	PO Box 3534 Paarl 7620 South Africa
<b>Tel</b>	+1 512 538 1995	+86 755 8303 5294 ext 808	+27 21 863 0033
<b>Email</b>	info@azoteq.com	info@azoteq.com	info@azoteq.com

*Visit [www.azoteq.com](http://www.azoteq.com)  
for a list of distributors and worldwide representation.*

Patents as listed on [www.azoteq.com/patents-trademarks/](http://www.azoteq.com/patents-trademarks/) may relate to the device or usage of the device.

Azoteq®, Crystal Driver®, IQ Switch®, ProxSense®, ProxFusion®, LightSense™, SwipeSwitch™, and the  logo are trademarks of Azoteq.

The information in this Datasheet is believed to be accurate at the time of publication. Azoteq uses reasonable effort to maintain the information up-to-date and accurate, but does not warrant the accuracy, completeness or reliability of the information contained herein. All content and information are provided on an “as is” basis only, without any representations or warranties, express or implied, of any kind, including representations about the suitability of these products or information for any purpose. Azoteq disclaims all warranties and conditions with regard to these products and information, including but not limited to all implied warranties and conditions of merchantability, fitness for a particular purpose, title and non-infringement of any third party intellectual property rights. Azoteq assumes no liability for any damages or injury arising from any use of the information or the product or caused by, without limitation, failure of performance, error, omission, interruption, defect, delay in operation or transmission, even if Azoteq has been advised of the possibility of such damages. The applications mentioned herein are used solely for the purpose of illustration and Azoteq makes no warranty or representation that such applications will be suitable without further modification, nor recommends the use of its products for application that may present a risk to human life due to malfunction or otherwise. Azoteq products are not authorized for use as critical components in life support devices or systems. No licenses to patents are granted, implicitly, express or implied, by estoppel or otherwise, under any intellectual property rights. In the event that any of the abovementioned limitations or exclusions does not apply, it is agreed that Azoteq’s total liability for all losses, damages and causes of action (in contract, tort (including without limitation, negligence) or otherwise) will not exceed the amount already paid by the customer for the products. Azoteq reserves the right to alter its products, to make corrections, deletions, modifications, enhancements, improvements and other changes to the content and information, its products, programs and services at any time or to move or discontinue any contents, products, programs or services without prior notification. For the most up-to-date information and binding Terms and Conditions please refer to [www.azoteq.com](http://www.azoteq.com).