

# ZB4BW347

Head for illuminated push button, Harmony XB4, red flush pushbutton Ø22 mm spring return BA9s bulb



## Main

Range of Product	Harmony XB4
Product or Component Type	Head for illuminated push-button
Device short name	ZB4
Product Compatibility	BA 9s
Bezel material	Black metal
Head type	Standard
Mounting diameter	0.87 in (22 mm)
Sale per indivisible quantity	1
Shape of signaling unit head	Round
Type of operator	Spring return
Operator profile	Red flush, unmarked
Operator additional information	With plain lens

## Complementary

CAD overall width	1.14 in (29 mm)
CAD overall height	1.14 in (29 mm)
CAD overall depth	1.26 in (32 mm)
Net Weight	0.06 lb(US) (0.027 kg)
Resistance to high pressure washer	1015.26 psi (7000000 Pa) 131 °F (55 °C) 0.1 m
Mechanical durability	10000000 cycles
Electrical composition code	M7 6 single front mounting BA 9s M8 6 single and double front mounting BA 9s M9 2 single front mounting BA 9s and transformer
Device presentation	Basic sub-assemblies

## Environment

Protective treatment	TH
Ambient Air Temperature for Storage	-40...158 °F (-40...70 °C)
Ambient Air Temperature for Operation	-40...158 °F (-40...70 °C)
Overvoltage category	Class I IEC 60536
IP degree of protection	IP66 IEC 60529 IP67 IP69 IP69K
NEMA degree of protection	NEMA 13 NEMA 4X
IK degree of protection	IK06 EN 50102
Standards	JIS C8201-5-1 EN/IEC 60947-5-1 CSA C22.2 No 14 EN/IEC 60947-5-5 EN/IEC 60947-5-4 EN/IEC 60947-1 UL 508 JIS C8201-1

The information provided in this documentation contains general descriptions and/or technical characteristics of the performance of the products contained herein. This documentation is not intended as a substitute for and is not to be used for determining suitability or reliability of these products for specific user applications. It is the duty of any such user or integrator to perform the appropriate and complete risk analysis, evaluation and testing of the products with respect to the relevant specific application or use thereof. Neither Schneider Electric Industries SAS nor any of its affiliates or subsidiaries shall be responsible or liable for misuse of the information contained herein.

Product Certifications	BV LROS (Lloyds register of shipping) DNV UL Listed CSA GL
Vibration resistance	5 gn 2...500 Hz)IEC 60068-2-6
Shock resistance	30 gn 18 ms) half sine wave acceleration IEC 60068-2-27 50 gn 11 ms) half sine wave acceleration IEC 60068-2-27







### Ordering and shipping details

Category	22468-PUSHBUTTONS,22MM(METAL) NEW
Discount Schedule	CS2
GTIN	3389110838978
Nbr. of units in pkg.	1
Package weight(Lbs)	0.95 oz (27.0 g)
Returnability	No
Country of origin	CZ

### Packing Units

Unit Type of Package 1	PCE
Package 1 Height	2.13 in (5.4 cm)
Package 1 width	1.34 in (3.4 cm)
Package 1 Length	1.73 in (4.4 cm)

### Offer Sustainability

Sustainable offer status	Green Premium product
REACH Regulation	 <a href="#">REACH Declaration</a>
REACH free of SVHC	Yes
EU RoHS Directive	Pro-active compliance (Product out of EU RoHS legal scope)  <a href="#">EU RoHS Declaration</a>
Toxic heavy metal free	Yes
Mercury free	Yes
RoHS exemption information	 <a href="#">Yes</a>
China RoHS Regulation	 <a href="#">China RoHS Declaration</a>
Environmental Disclosure	 <a href="#">Product Environmental Profile</a>
Circularity Profile	 <a href="#">End Of Life Information</a>

### Contractual warranty

Warranty	18 months
----------	-----------

---

Dimensions

---

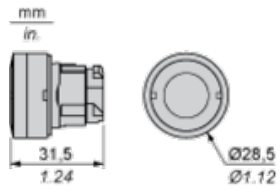

Panel Cut-out for Pushbuttons, Switches and Pilot Lights (Finished Holes, Ready for Installation)

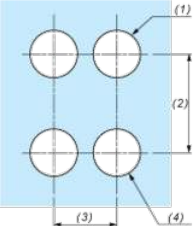
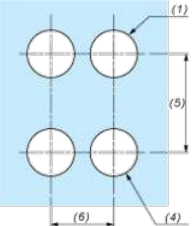
Connection by Screw Clamp Terminals or Plug-in Connectors or on Printed Circuit Board	Connection by Faston Connectors
	
<p>(1) Diameter on finished panel or support                  (2) 40 mm min. / 1.57 in. min.                  (3) 30 mm min. / 1.18 in. min.                  (4) <math>\varnothing 22.5</math> mm / 0.89 in. recommended (<math>\varnothing 22.3</math> mm <math>_0^{+0.4}</math> / 0.88 in. <math>_0^{+0.016}</math>)                  (5) 45 mm min. / 1.78 in. min.                  (6) 32 mm min. / 1.26 in. min.</p>	

Pushbuttons, Switches and Pilot Lights for Printed Circuit Board Connection

Panel Cut-outs (Viewed from Installer's Side)

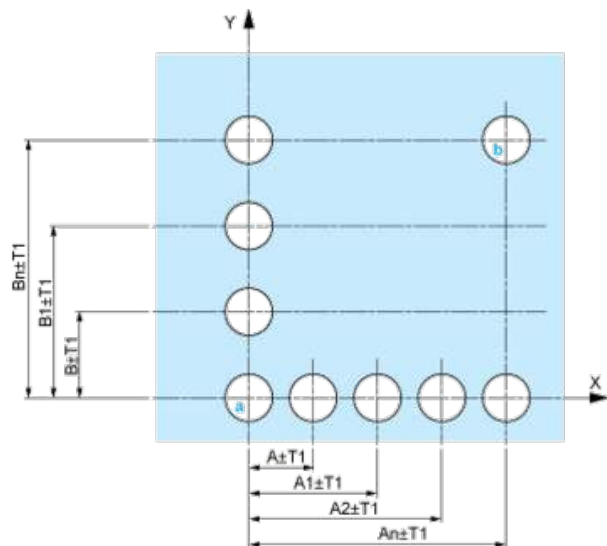

A: 30 mm min. / 1.18 in. min.  
 B: 40 mm min. / 1.57 in. min.

Printed Circuit Board Cut-outs (Viewed from Electrical Block Side)

Dimensions in mm

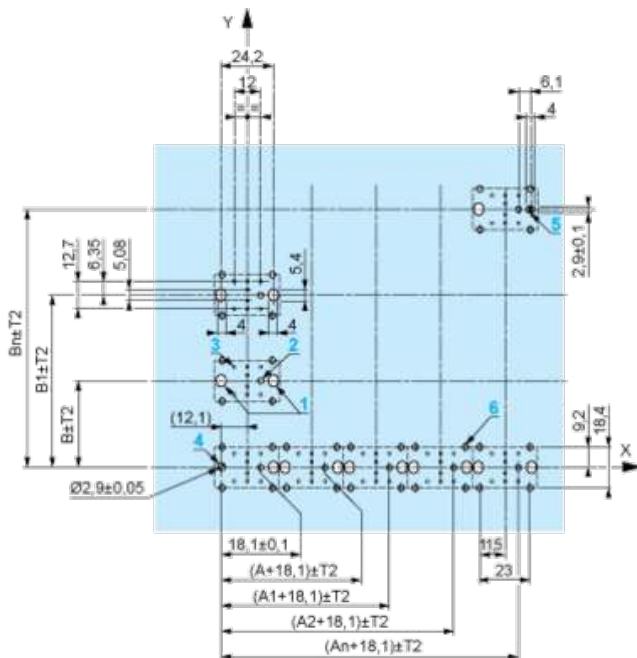

A: 30 mm min.  
 B: 40 mm min.  
 Dimensions in in.

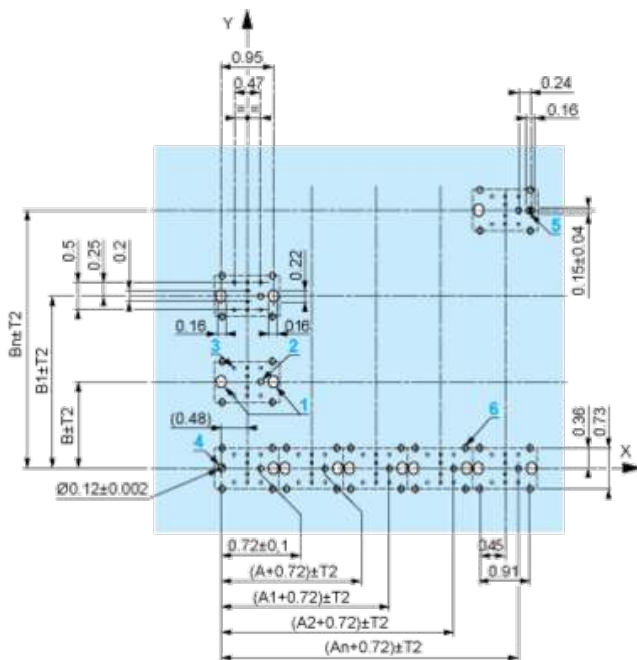

A: 1.18 in. min.  
 B: 1.57 in. min.

### General Tolerances of the Panel and Printed Circuit Board

The cumulative tolerance must not exceed 0.3 mm / 0.012 in:  $T1 + T2 = 0.3 \text{ mm max.}$

### Installation Precautions

- Minimum thickness of circuit board: 1.6 mm / 0.06 in.
- Cut-out diameter: 22.4 mm  $\pm$  0.1 / 0.88 in.  $\pm$  0.004
- Orientation of body/fixing collar ZB4 BZ009:  $\pm 2^\circ 30'$  (excluding cut-outs marked a and b).
- Tightening torque of screws ZBZ 006: 0.6 N.m (5.3 lbf.in) max.
- Allow for one ZB4 BZ079 fixing collar/pillar and its fixing screws:
  - every 90 mm / 3.54 in. horizontally (X), and 120 mm / 4.72 in. vertically (Y).
  - with each selector switch head (ZB4 BD•, ZB4 BJ•, ZB4 BG•).

The fixing centers marked a and b are diagonally opposed and must align with those marked 4 and 5.

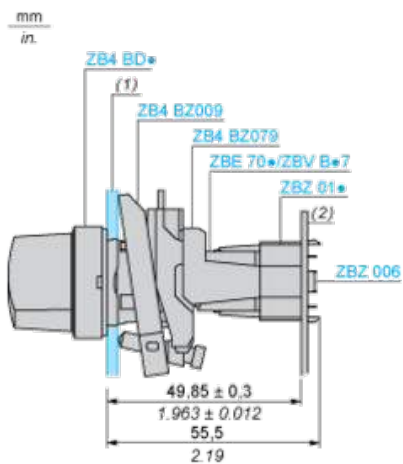

(1) Panel

(2) Printed circuit board

### Mounting of Adapter (Socket) ZBZ 01•

- 1 2 elongated holes for ZBZ 006 screw access
- 2 1 hole  $\varnothing 2.4 \text{ mm} \pm 0.05 / 0.09 \text{ in.} \pm 0.002$  for centring adapter ZBZ 01•
- 3 8 ×  $\varnothing 1.2 \text{ mm} / 0.05 \text{ in.}$  holes
- 4 1 hole  $\varnothing 2.9 \text{ mm} \pm 0.05 / 0.11 \text{ in.} \pm 0.002$ , for aligning the printed circuit board (with cut-out marked a)
- 5 1 elongated hole for aligning the printed circuit board (with cut-out marked b)
- 6 4 holes  $\varnothing 2.4 \text{ mm} / 0.09 \text{ in.}$  for clipping in adapter ZBZ 01•

Dimensions An + 18.1 relate to the  $\varnothing 2.4 \text{ mm} \pm 0.05 / 0.09 \text{ in.} \pm 0.002$  holes for centring adapter ZBZ 01•.

---

Electrical Composition Corresponding to Codes M1 and M7

---

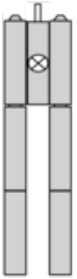

---

Electrical Composition Corresponding to Codes M2 and M8

---

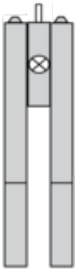

---

Electrical Composition Corresponding to Code M9

---



---

Legend

---

Single contact

Double contact

Light block

Possible location

