

ENG. NO.
SD-51041-***0*

EDP NO.

ALL DIMENSIONS IN METRIC DO NOT SCALE DRAWING

OPTION B

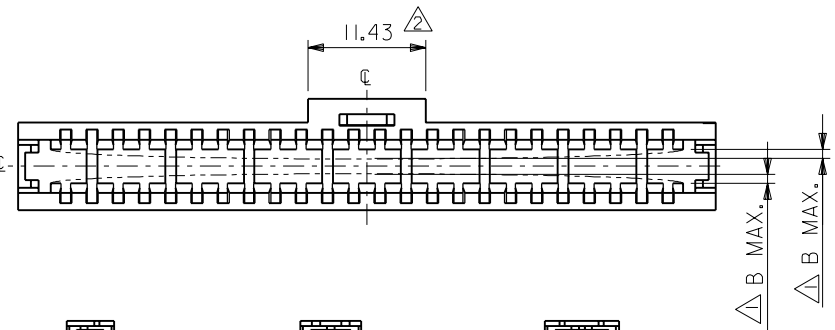
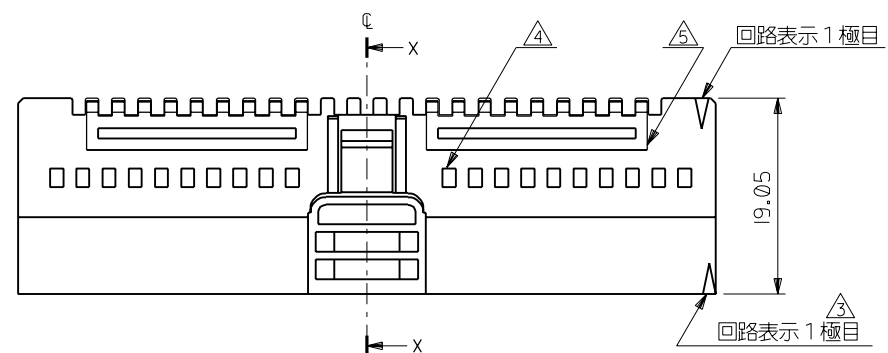
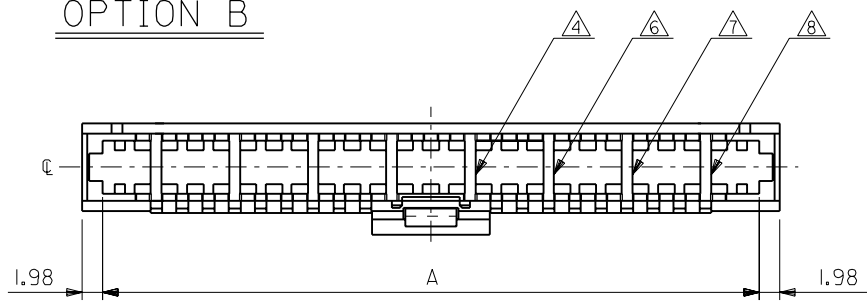

4極の場合
(SCALE:1-1)

6極の場合
(SCALE:1-1)

8極の場合
(SCALE:1-1)

注記

- △ 内ソリ寸法を表わす。
- △ 6極以上に適用し、4極のみ9.29とする。
- △ 10極以上に存在する。
- △ 図面指示の穴及びリブは、14極以上に存在する。
- △ 図面指示のリブは、18極以上に存在する。
- △ 図面指示のリブは、26極以上に存在する。
- △ 図面指示のリブは、38極以上に存在する。
- △ 図面指示のリブは、50極以上に存在する。
- 9. 本図は、50極を示す。

- 10. 適合フリップ: 51043-****
- 11. 適合メスコネクター: 51030-***2*
52108-****
- 12. 適合ヘッダー: 53106-****
53107-****
- 13.ハウジングの色
(ENG. No. の下1桁に対応する.):
 白色 : 51041-***00
 赤色 : 51041-***02
 黄色 : 51041-***03
 青色 : 51041-***04

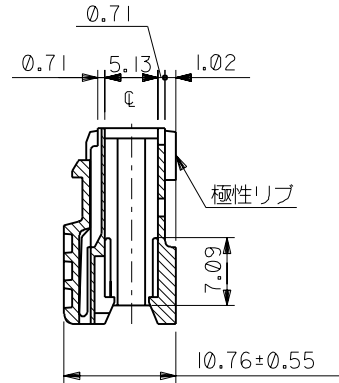

断面 X-X

0.30	63.75	51041-500*	50
0.29	61.21	-480*	48
0.28	58.67	-460*	46
0.27	56.13	-440*	44
0.26	53.59	-420*	42
0.25	51.05	-400*	40
0.24	48.51	-380*	38
0.23	45.97	-360*	36
0.22	43.43	-340*	34
0.21	40.89	-320*	32
0.20	38.35	-300*	30
0.19	35.81	-280*	28
0.18	33.27	-260*	26
0.17	30.73	-240*	24
0.16	28.19	-220*	22
0.15	25.65	-200*	20
0.14	23.11	-180*	18
0.13	20.57	-160*	16
0.12	18.03	-140*	14
0.11	15.49	-120*	12
0.09	12.95	-100*	10
0.08	10.41	-080*	8
0.08	7.87	-060*	6
0.08	5.33	51041-040*	4
△ B MAX.	A	ENG. No.	極数

角度 ANGLE	±3°	C 変更 (T90088)	H/H M.S 3/20/88	材料 MATERIAL	ガラス入り ポリエステル
30°以上 OVER	+0.3	B 変更 (T80101)	H/H A.A 5/25/88	仕上げ FINISH	UL 94V-0
10°以上 OVER 30°未満 UNDER	+0.25	A 変更 (T80060)	H/H A.A 4/27/88	適用電線範囲 WIRE RANGE	—
10°未満 UNDER	+0.2	0 新規作成	H/H A.A 1/11/88	被覆外径 INS. RANGE	—
一般公差 GENERAL TOLERANCES		記号 LTR	変更内容 REVISION RECORD	DR. CHK. DATE	DRAWN BY: 1/11/88 H. HIRATA
					CHK'D BY: Y. ITO
					APP'D BY: A. ASO
					尺度 SCALE 2-1

molex MOLEX-JAPAN CO.,LTD. 日本モレックス株式会社	
EDP. NO.	—
ENG. NO.	SD-51041-***0*
TITLE 名称 (OPTION B)	J-SL 2.54 DUAL ROW INTERIM CLIP
REV	C

ENC. NO. SD-51041-***0*
EDP NO.
DIMENSIONS IN METRIC DO NOT SCALE DRAWING

OPTION B

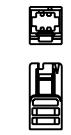
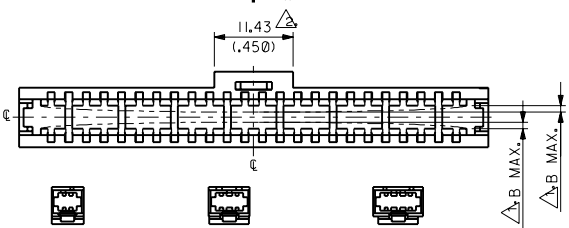
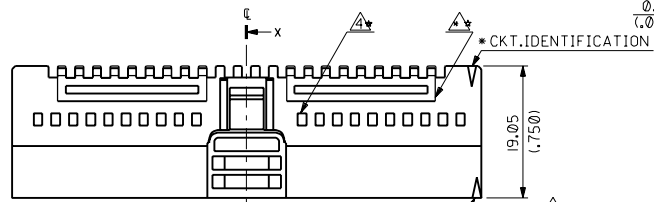
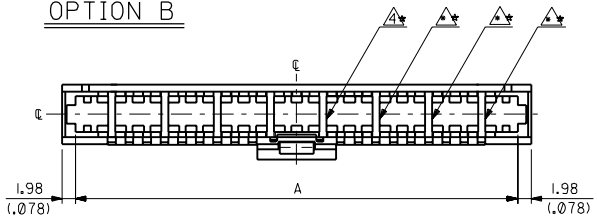

4 CKTS.
(SCALE:1-1)

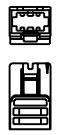

6 CKTS.
(SCALE:1-1)

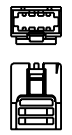

8 CKTS.
(SCALE:1-1)

NOTES:

- △ TO BE INDICATED AN INWARD BOW TO BE APPLIED FOR 6 CKTS. VERSION AND MORE THAN 6 CKTS. FOR 4 CKTS. VERSION, 9.29/(.366) SHOULD BE APPLIED.
- △ TO BE PROVIDED FOR 10 CKTS. VERSION AND MORE THAN 10 CKTS..
- △ INDICATED HOLES AND RIBS IN THE DRAWING ARE PROVIDED FOR 14 CKTS. VERSION AND MORE THAN 14 CKTS..
- △ INDICATED RIBS IN THE DRAWING ARE PROVIDED FOR 18 CKTS. VERSION AND MORE THAN 18 CKTS..
- △ INDICATED RIBS IN THE DRAWING ARE PROVIDED FOR 26 CKTS. VERSION AND MORE THAN 26 CKTS..
- △ INDICATED RIBS IN THE DRAWING ARE PROVIDED FOR 30 CKTS. VERSION AND MORE THAN 30 CKTS..
- △ INDICATED RIBS IN THE DRAWING ARE PROVIDED FOR 50 CKTS. VERSION AND MORE THAN 50 CKTS..
- 9. 50 CKTS. VERSION IS SHOWN IN THIS DRAWING.

- 10. APPLICABLE CLIP: 51043-****
- 11. APPLICABLE FEMALE CONNECTOR: 51030-**-2- 52108-****
- 12. APPLICABLE HEADER: 53106-****, 53107-****
- 13. COLOR OF HOUSING (INDICATED BY THE LAST DIGIT):
 WHITE : 51041-**-00
 RED : 51041-**-02
 YELLOW : 51041-**-03
 BLUE : 51041-**-04

METRIC (INCH)

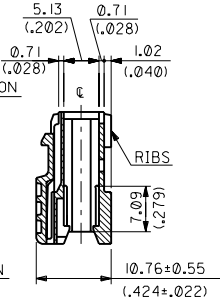

0.30/(0.12)	63.75/(2.510)	51041-500*	50
0.29/(0.11)	61.21/(2.410)	-480*	48
0.28/(0.11)	58.67/(2.310)	-460*	46
0.27/(0.11)	56.13/(2.210)	-440*	44
0.26/(0.10)	53.59/(2.110)	-420*	42
0.25/(0.10)	51.05/(2.010)	-400*	40
0.24/(0.09)	48.51/(1.910)	-380*	38
0.23/(0.09)	45.97/(1.810)	-360*	36
0.22/(0.09)	43.43/(1.710)	-340*	34
0.21/(0.08)	40.89/(1.610)	-320*	32
0.20/(0.08)	38.35/(1.510)	-300*	30
0.19/(0.07)	35.81/(1.410)	-280*	28
0.18/(0.07)	33.27/(1.310)	-260*	26
0.17/(0.07)	30.73/(1.210)	-240*	24
0.16/(0.06)	28.19/(1.110)	-220*	22
0.15/(0.06)	25.65/(1.010)	-200*	20
0.14/(0.06)	23.11/(0.910)	-180*	18
0.13/(0.05)	20.57/(0.810)	-160*	16
0.12/(0.05)	18.03/(0.710)	-140*	14
0.11/(0.04)	15.49/(0.610)	-120*	12
0.09/(0.04)	12.95/(0.510)	-100*	10
0.08/(0.03)	10.41/(0.410)	-080*	8
0.08/(0.03)	7.87/(0.310)	-060*	6
0.08/(0.03)	5.33/(0.210)	51041-040*	4
A.B. MAX.	A	ENG. No.	CKTS.

角度 ANGLE	±3°
30°以上 OVER	+0.3
10%片 UNDER	+0.25
10%片 UNDER	+0.2
一般公差 UNIT/INCH GENERAL TOLERANCES	

0	RELEASED	(1990/08)	DR. CHK. DATE
1	TRN	REVISION RECORD	DR. CHK. DATE
REVISE ONLY ON CAD SYSTEM			

材料 MATERIAL	GLASS FILLED POLYESTER UL 94V-0
仕上 FINISH	UL 94V-0
適用電線範囲 WIRE RANGE	—
被覆外径 INS. RANGE	—
DRAWN BY	M. Watanabe
CHKD BY	M. Watanabe
APP'D BY	
尺度 SCALE	2-1

EDP. NO.	—
ENG. NO.	SD-51041-**-0*
REV	0
TITLE 名称	J-SL 2.54 DUAL ROW INTERIM CLIP
OPTION B)	