

SMD ■ REFLECTOR EAPL2214WA0

PRELIMINARY



Features

- .White SMT package.
- .Optical indicator.
- .Wide viewing angle.
- .Soldering methods: IR reflow soldering.
- .Available on tape and reel.
- .ESD protection
- .Pb-free
- .The product itself will remain within RoHS compliant version.

Applications

- .Optical indicators.
- .Coupling into light guides.
- .Backlighting (LCD, cellular phones, switches, keys, displays, illuminated advertising, general lighting).
- .Coupling into light guides.

Device Selection Guide

Chip Materials	Emitted Color	Resin Color
InGaN	Pure White	Water Clear

Absolute Maximum Ratings (Ta=25°C)

Parameter	Symbol	Rating	Unit
Reverse Voltage	V _R	5	V
Forward Current	I _F	30	mA
Peak Forward Current (Duty 1/10 @1KHz)	I _{FP}	100	mA
Power Dissipation	P _d	110	mW
Electrostatic Discharge(HBM)	ESD	2000	V
Operating Temperature	T _{opr}	-40 ~ +85	°C
Storage Temperature	T _{stg}	-40 ~ +90	°C
Soldering Temperature	T _{sol}	Reflow Soldering : 260 °C for 10 sec. Hand Soldering : 350 °C for 3 sec.	

Electro-Optical Characteristics (Ta=25°C)

Parameter	Symbol	Min.	Typ.	Max.	Units	Condition
Luminous Intensity	I _v	715	-----	1800	mcd	I _F =20mA
Viewing Angle	2θ1/2	-----	120	-----	deg	I _F =20mA
Forward Voltage	V _F	2.75	-----	3.65	V	I _F =20mA

Note:

1. Tolerance of Luminous Intensity: ±11%
2. Tolerance of Dominant Wavelength: ±1nm
3. Tolerance of Forward Voltage: ±0.1V

Bin Range of Luminous Intensity

Bin Code	Min.	Max.	Unit	Condition
V1	715	900	mcd	I _F =20mA
V2	900	1120		
W1	1120	1420		
W2	1420	1800		

Note:

Tolerance of Luminous Intensity: ±11%

Bin Range of Forward Voltage

Group	Bin Code	Min.	Max.	Unit	Condition
E	5	2.75	3.05	V	I _F =20mA
	6	3.05	3.35		
	7	3.35	3.65		

Note:

Tolerance of Forward Voltage $\pm 0.1V$

Bin Range of Chromaticity Coordinates

Group	Bin Code	CIE_x	CIE_y	Bin Code	CIE_x	CIE_y
F	B3	0.287	0.295	B5	0.296	0.276
		0.283	0.305		0.287	0.295
		0.304	0.330		0.307	0.315
		0.307	0.315		0.311	0.294
	B4	0.307	0.315	B6	0.311	0.294
		0.304	0.33		0.307	0.315
		0.33	0.36		0.330	0.339
		0.33	0.339		0.330	0.318

Note:

Tolerance of Chromaticity Coordinates: ± 0.01

The C.I.E. 1931 chromaticity diagram.

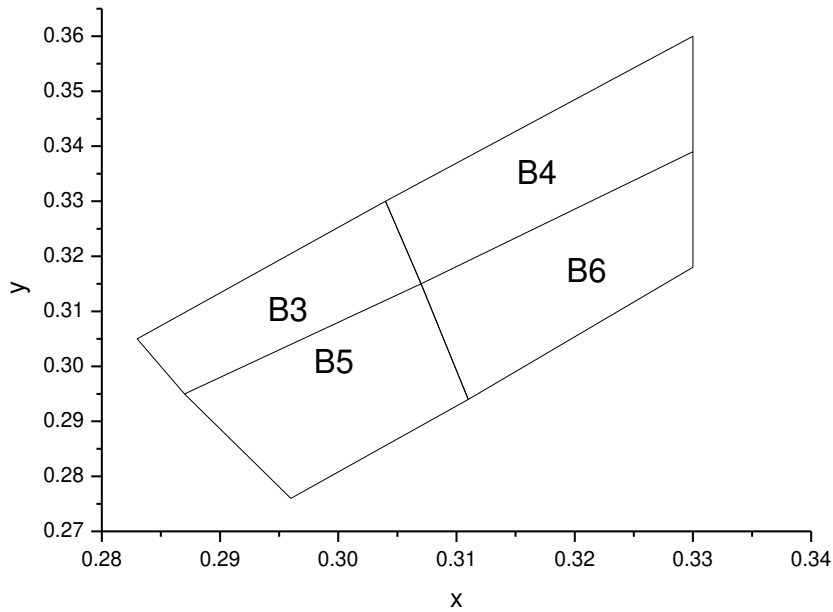

Typical Electro-Optical Characteristics Curves

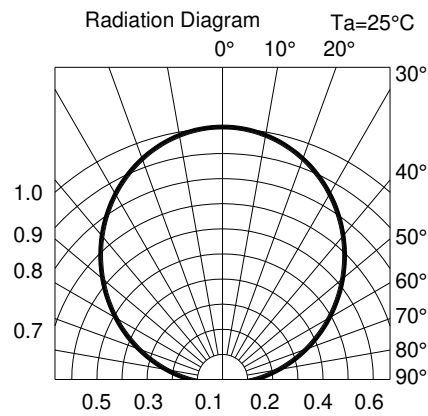
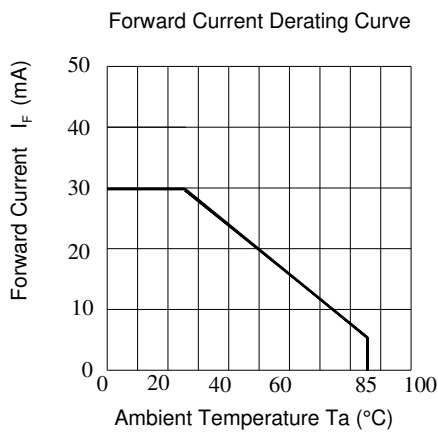
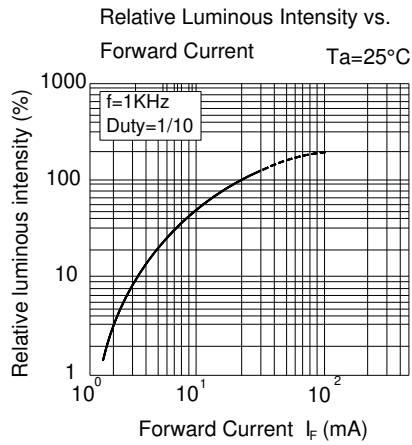
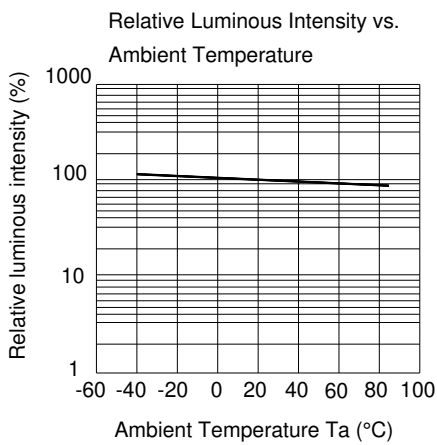
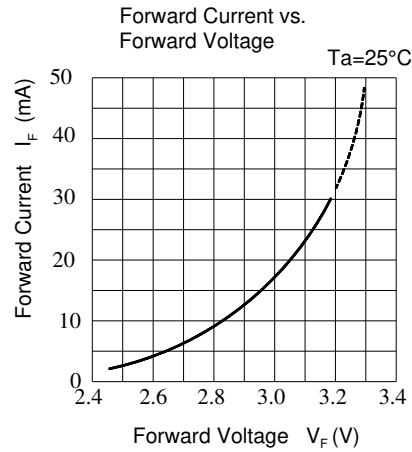
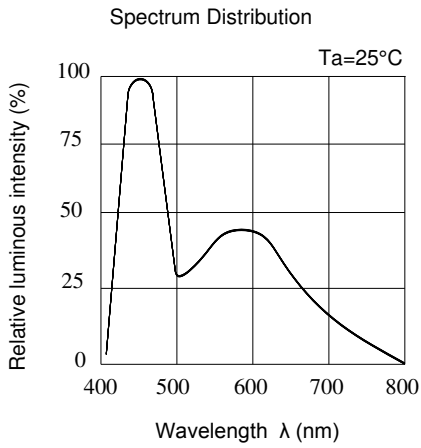

Package Dimension

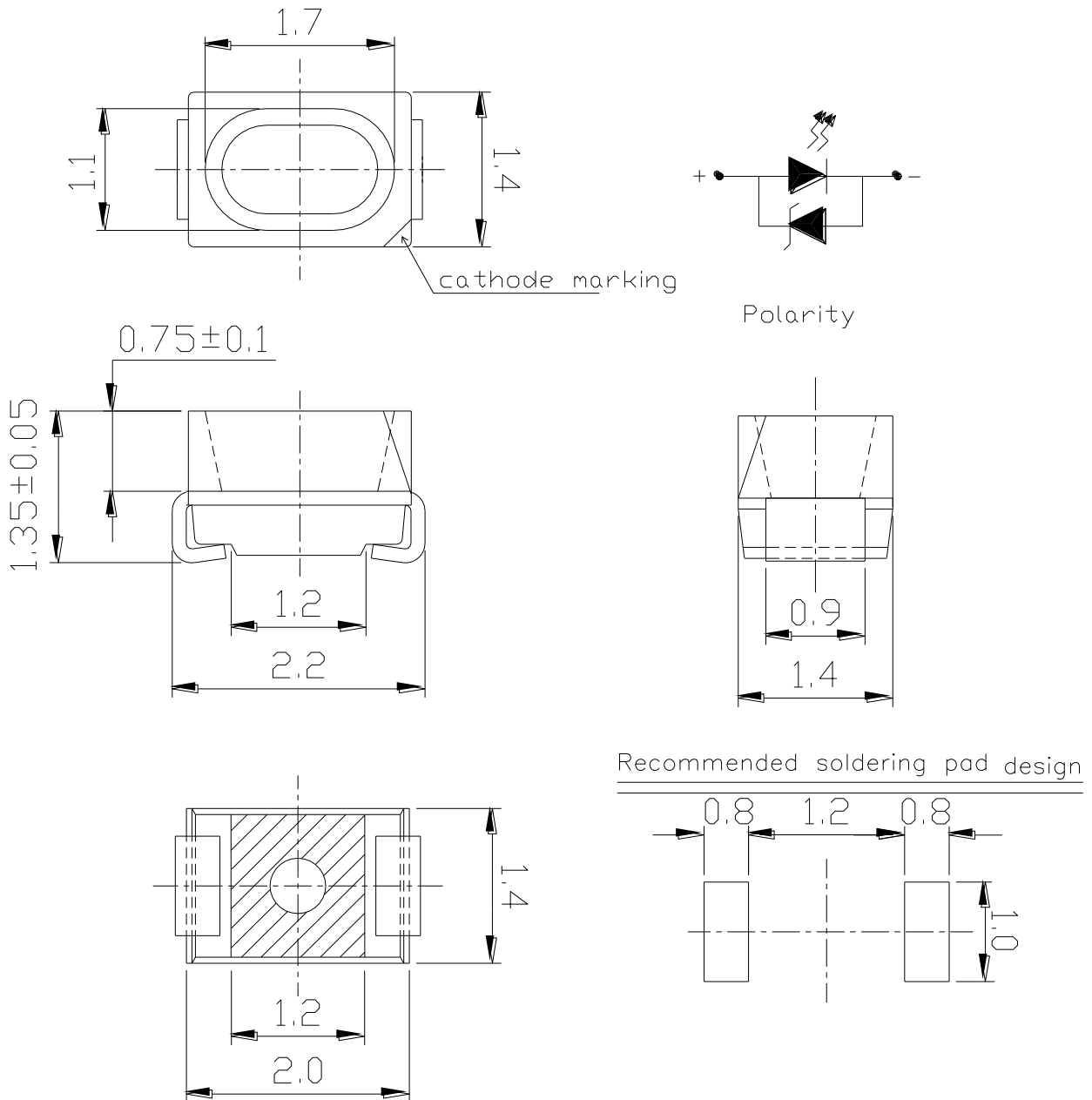

Note: Tolerances unless mentioned ± 0.1 mm. Unit = mm

Moisture Resistant Packing Materials

Label Explanation



CAT: Luminous Intensity Rank

HUE: Dom. Wavelength Rank

REF: Forward Voltage Rank

Reel Dimensions

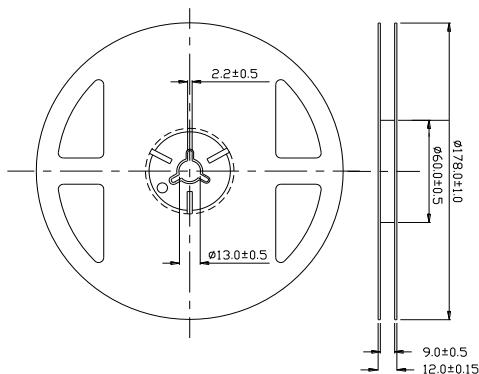

Carrier Tape Dimensions: Loaded Quantity 2000 pcs Per Reel

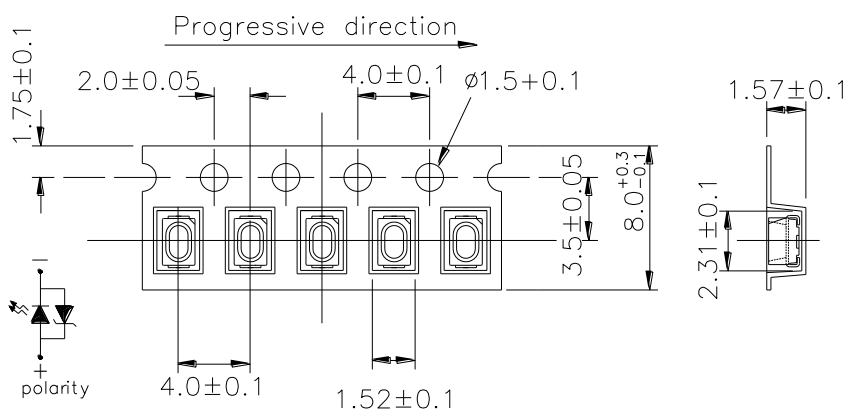

Note: Tolerances unless mentioned ± 0.1 mm. Unit = mm

Moisture Resistant Packing Process

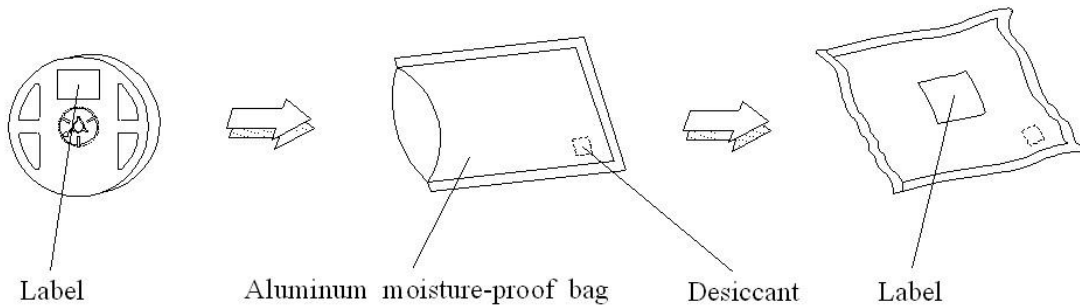

Note: Tolerances unless mentioned $\pm 0.1\text{mm}$. Unit = mm

Reliability Test Items and Conditions

The reliability of products shall be satisfied with items listed below.

Confidence level : 90%

LTPD : 10%

No.	Items	Test Condition	Test Hours/Cycles	Sample Size	Ac/Re
1	Reflow Soldering	Temp. : $260^{\circ}\text{C}\pm 5^{\circ}\text{C}$ Min. 5sec.	6 min	22 PCS.	0/1
2	Temperature Cycle	H : $+100^{\circ}\text{C}$ 15min \int 5 min L : -40°C 15min	300 Cycles	22 PCS.	0/1
3	Thermal Shock	H : $+100^{\circ}\text{C}$ 5min \int 10 sec L : -10°C 5min	300 Cycles	22 PCS.	0/1
4	High Temperature Storage	Temp. : 100°C	1000 Hrs.	22 PCS.	0/1
5	Low Temperature Storage	Temp. : -40°C	1000 Hrs.	22 PCS.	0/1
6	DC Operating Life	IF = 20 mA	1000 Hrs.	22 PCS.	0/1
7	High Temperature / High Humidity	$85^{\circ}\text{C} / 85\%\text{RH}$	1000 Hrs.	22 PCS.	0/1

Precautions For Use

1. Over-current-proof

Customer must apply resistors for protection, otherwise slight voltage shift will cause big current change (Burn out will happen).

2. Storage

2.1 Do not open moisture proof bag before the products are ready to use.

2.2 Before opening the package: The LEDs should be kept at 30°C or less and 90%RH or less.

2.3 After opening the package: The LED's floor life is 48 hours under 30°C or less and 60% RH or less. If unused LEDs remain, should be stored in moisture proof packages.

2.4 If the moisture absorbent material (silica gel) has faded away or the LEDs have exceeded the storage time, baking treatment should be performed using the following conditions.

Baking treatment : 60±5°C for 24 hours.

3. Soldering Condition

3.1 Pb-free solder temperature profile

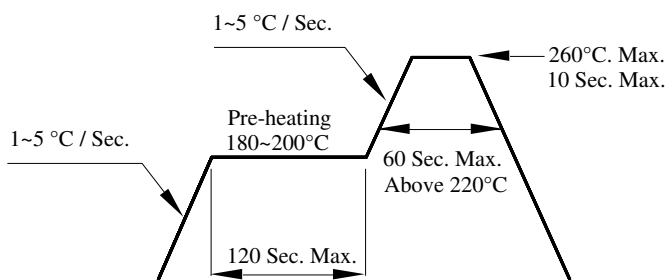

3.2 Reflow soldering should not be done more than two times.

3.3 When soldering, do not put stress on the LEDs during heating.

3.4 After soldering, do not warp the circuit board.

4. Soldering Iron

Each terminal is to go to the tip of soldering iron temperature less than 350°C for 3 seconds within once in less than the soldering iron capacity 25W. Leave two seconds and more intervals, and do soldering of each terminal. Be careful because the damage of the product is often started at the time of the hand solder.

5. Repairing

Repair should not be done after the LEDs have been soldered. When repairing is unavoidable, a double-head soldering iron should be used (as below figure). It should be confirmed beforehand whether the characteristics of the LEDs will or will not be damaged by repairing.

