



# Wireless Vehicle Bus Adapter (WVA)

---

Getting Started Guide

## Revision history—90001929

Revision	Date	Description
F	November 2017	Added information for reviewing fault codes in the demo application.
G	June 2019	Updated graphics in <a href="#">Network Service Configuration page descriptions</a> .
H	January 2021	Added <a href="#">Anatel</a> information.
J	February 2021	Updated <a href="#">Anatel</a> information.
K	September 2022	Added info for J250 model. <ul style="list-style-type: none"><li>■ <a href="#">Wireless Vehicle Bus Adapter Getting Started Guide</a></li><li>■ <a href="#">Regulatory information</a></li></ul>

## Trademarks and copyright

Digi, Digi International, and the Digi logo are trademarks or registered trademarks in the United States and other countries worldwide. All other trademarks mentioned in this document are the property of their respective owners.

© 2021 Digi International Inc. All rights reserved.

## Disclaimers

Information in this document is subject to change without notice and does not represent a commitment on the part of Digi International. Digi provides this document “as is,” without warranty of any kind, expressed or implied, including, but not limited to, the implied warranties of fitness or merchantability for a particular purpose. Digi may make improvements and/or changes in this manual or in the product(s) and/or the program(s) described in this manual at any time.

## Warranty

To view product warranty information, go to the following website:

[www.digi.com/howtobuy/terms](http://www.digi.com/howtobuy/terms)

## Send comments

**Documentation feedback:** To provide feedback on this document, send your comments to [techcomm@digi.com](mailto:techcomm@digi.com).

## Customer support

**Digi Technical Support:** Digi offers multiple technical support plans and service packages to help our customers get the most out of their Digi product. For information on Technical Support plans and pricing, contact us at +1 952.912.3444 or visit us at [www.digi.com/support](http://www.digi.com/support).

# Contents

---

## Wireless Vehicle Bus Adapter Getting Started Guide

Features .....	7
Models .....	8
Setting up your Wireless Vehicle Bus Adapter .....	8

## Connect the hardware

Verify product components .....	10
Optional equipment .....	10
Communications equipment .....	10
Recommended CAN bus simulator model .....	11
Connect the WVA to a CAN simulator .....	11
Connect the WVA to a vehicle's diagnostic port .....	12
Remove the WVA from the diagnostic port .....	13
WVA LEDs .....	14
Power LED .....	14
User-defined LED .....	14

## Connect to the WVA

Connect to the WVA from a smart phone or tablet .....	16
Connect to the WVA from a laptop .....	16

## Access and use the WVA web interface

Apply and save changes .....	19
Cancel changes to configuration settings .....	19
Open the web interface .....	19
Upload a file to the WVA .....	20

## Configure the WVA

Configure wireless settings .....	22
Configure WVA for Wi-Fi Infrastructure mode .....	22
Configure WVA for Wi-Fi Direct .....	24
Configure CAN bus baud rate (CAN bus simulator use only) .....	27
Configure Python programs .....	28
Start or stop an already configured Python application .....	29
Determine whether Python applications are running .....	30

Configure network services .....	30
Configure power management settings .....	31
About power management .....	33
Enable Remote Manager connectivity (optional) .....	33

## Manage the WVA device

Rediscover the WVA .....	36
Reboot the WVA .....	37
Reset the WVA to factory defaults .....	37
Disable and enable the factory reset button .....	37
Disable the factory reset button .....	37
Enable the factory reset button .....	37
WVA filesystem and file management .....	37
Access/Browse the filesystem from device interfaces .....	38
View the system log .....	38
Log files and contents .....	39
View status information .....	42

## Deployment decisions

Default behavior regarding time .....	43
Default behavior regarding Wi-Fi network connectivity .....	43
Default behavior regarding Remote Manager connectivity .....	43
Default behavior regarding IP address assignment .....	43

## WVA web interface page descriptions

Adapter Status page descriptions .....	46
CAN Bus page descriptions .....	47
Device Information page descriptions .....	47
File Management page descriptions .....	49
Network Service Configuration page descriptions .....	50
Power Management Configuration page descriptions .....	51
Python Configuration page descriptions .....	52

## Run the WVA demo application

Get started .....	54
Learn the demo application software features .....	54
Build your own application .....	54
Download the demo application .....	54
Start the demo application and discover WVA devices .....	55
Discover the WVA .....	56
Connect to the WVA .....	56
Optional: Manually connect to the WVA .....	57
Review the demo application dashboard .....	57
Show graph view .....	58
Configure endpoints: subscriptions and alarms .....	58
Subscribe to an endpoint .....	59
Configure an endpoint as an alarm .....	61
Delete an alarm .....	63
Change application settings .....	64

Review fault codes .....	65
Demo application issues .....	67
Demo application error messages .....	68
Demo application: Wi-Fi hotspot issues .....	68
Demo application: user login fails .....	68
Demo application: Connection Refused error (ECONNREFUSED) .....	69
Demo application: Connection has gone away error .....	69

## Troubleshooting

Power LED is dark .....	72
Device is not discovered by Digi Device Discovery .....	73
Cannot open web interface or access web services .....	75
Cannot receive data from the CAN bus .....	76
WVA does not connect to an access point .....	77
Wi-Fi access issues .....	78
Cannot discover device using Wi-Fi Direct .....	79
Cannot associate with WVA over Wi-Fi Direct in push-button mode .....	80
Cannot associate with WVA over Wi-Fi Direct in PIN mode .....	81
Wireless signal strength issues .....	82

## Regulatory information

Anatel .....	83
--------------	----

## Wireless Vehicle Bus Adapter Getting Started Guide

---

The Wireless Vehicle Bus Adapter (WVA) is a telematics component that makes vehicle bus data available through wireless communication. Using Wi-Fi, the WVA connects to other intelligent devices or routers as a client, host, or through a Wi-Fi Direct connection. The WVA can accommodate vehicle bus data in J1939/CAN or J1587/J1708 form.

You can use the WVA in a desktop development environment with a CAN bus simulator, and can install it in a vehicle by plugging into the vehicle's diagnostic port.

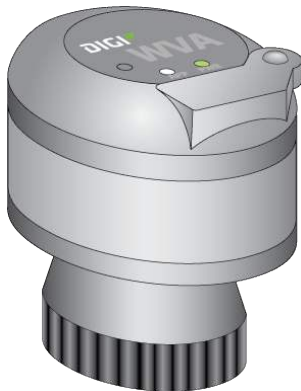

The WVA provides an option for wireless connectivity within the vehicle cab as an alternative to wired installation process. If you already have a system that includes an on-board computer (OBC) with Wi-Fi capabilities in your vehicles, you can integrate the WVA into your existing system. If you have not yet installed an OBC in your vehicles, you can use a smart phone, tablet, or rugged display combined with a custom application to interact with the WVA.

### Features

- Embedded Wi-Fi with b/g/n Internet speeds
- Standard Deutsch 9-pin diagnostic port connector
- Two J1939/CAN vehicle bus interfaces
- J1587/J1708 vehicle bus interface
- LEDs to indicate power and user-defined functions in applications
- 12 VDC power through a vehicle diagnostic port; can be powered directly from the vehicle
- Basic power management
- Custom buzzer for driver alerts

- Web interface for configuration and management, password-protected
- Web services, a RESTful programming interface to vehicle data, password-protected

For detailed hardware specifications, see the [Hardware](#) topic of the *Wireless Vehicle Bus Adapter (WVA) Application Developer's Guide*.

## Models

The information in this guide is for the following models:

- **J250**: This model is certified for the US regulatory domain only.
- **J200**

For regulatory information, see [Regulatory information](#).

## Setting up your Wireless Vehicle Bus Adapter

This *Getting Started Guide* walks you through the steps to set up your Wireless Vehicle Bus Adapter. These steps include:

1. [Connect the hardware](#)
2. [Evaluate deployment decisions](#)
3. [Connect to the WVA](#)
4. [Configure the WVA](#)
5. [Run the WVA demo application](#)

In addition, the [Troubleshooting](#) section provides troubleshooting tips.



## Connect the hardware

---

You can use the WVA for desktop development with a CAN simulator, or plug it into a vehicle's diagnostic port.

Follow the steps in this section to connect the WVA hardware.

Verify product components .....	10
Recommended CAN bus simulator model .....	11
Connect the WVA to a CAN simulator .....	11
Connect the WVA to a vehicle's diagnostic port .....	12
Remove the WVA from the diagnostic port .....	13
WVA LEDs .....	14

## Verify product components

The Wireless Vehicle Bus Adapter includes the following components. Make note of any missing or damaged item and contact your supplier.

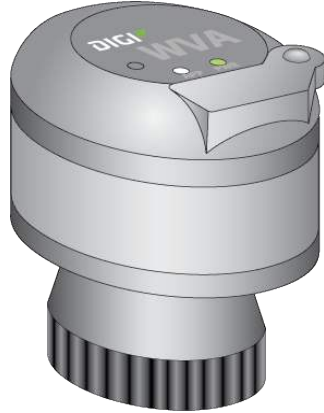

Wireless Vehicle Bus Adapter

SSID: wva-00:40:9D:5C:49:98  
PASS: AZ09azAZ09azAZ



QR code label

## Optional equipment

You can order the following equipment separately, if needed.



CAN bus simulator and optional recommended cabling for connecting to the computer.

**Note** This part is not sold by Digi International Inc. See [Recommended CAN bus simulator model](#) for ordering information.



Wiring harness  
[Digi part number 76000931](#)

## Communications equipment

You will need a mobile device to interact with the WVA, such as a laptop, tablet or smart phone.

## Recommended CAN bus simulator model

For the CAN simulator, Digi recommends the following model and part number, which you can order from the [AU Group Electronics on-line store](#):

- **Model:** Au SAE J1939 Simulator-Gen II 1.00A (Engine Basic Edition)
- **Part number:** SIMJ1939-001

The CAN simulator connects directly to the WVA wiring harness.

You can also purchase cabling to connect the CAN simulator to a PC from [AU Group Electronics](#).

## Connect the WVA to a CAN simulator

Follow this process to connect a WVA device to a CAN simulator.

---

**Note** You can skip this process if you are connecting the WVA to a vehicle. See [Connect the WVA to a vehicle's diagnostic port](#).

---

1. Before you begin, you should manually set the baud rate for the CAN simulator. See [Configure CAN bus baud rate \(CAN bus simulator use only\)](#).
2. Locate the alignment pin on the WVA and the wiring harness.
3. Following the pin alignment indicated by the alignment pin, connect the WVA to the 9-pin connector of the wiring harness. Locate the locking ring on the base of the WVA and twist it clockwise to lock in place.

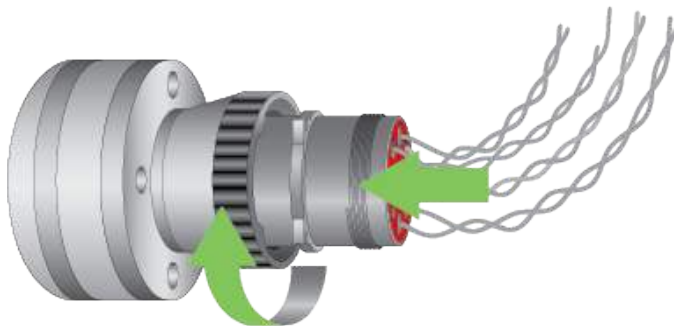

4. On the wiring harness, connect the wiring leads labeled **CAN J1939** or **J1708** to the **BUS** connector of the CAN simulator, following the CAN simulator's installation instructions. The image shows only one CAN connection. Connect additional J1939/CAN or J1587/J1708 leads as required.



**CAUTION!** Do not allow bare wires of the wiring harness to touch the CAN simulator. Touching the bare wires to the CAN simulator can cause a short circuit which can damage the CAN simulator.

---

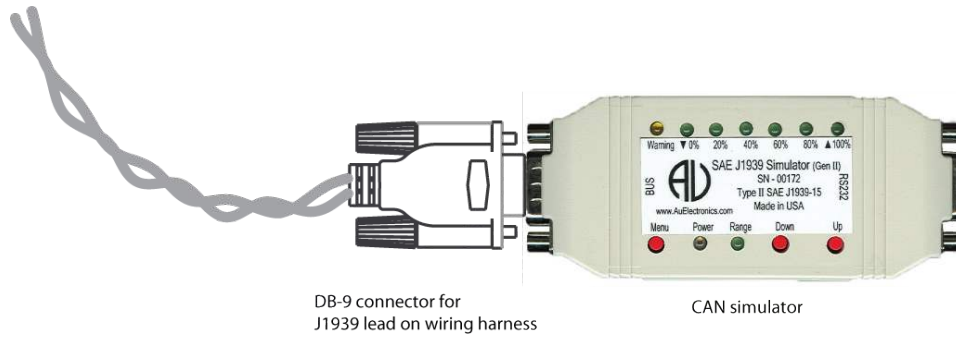

5. Connect the power supply for the cable harness to a power source.



**CAUTION!** When the WVA is being used with a CAN simulator, please note that its baud rate must be manually set to **250000**. Failure to set the baud rate to **250000** results in a baud rate mismatch, which impacts vehicle bus data. An indicator that the baud rate is set wrong is the apparent absence of vehicle data. See [Configure CAN bus baud rate \(CAN bus simulator use only\)](#) and [Cannot receive data from the CAN bus](#).

## Connect the WVA to a vehicle's diagnostic port

Follow this process to connect a WVA to a vehicle's diagnostic port.

**Note** You can skip this process if you are connecting a WVA device to a CAN simulator. See [Connect the WVA to a CAN simulator](#).

The WVA is compatible with 9-pin diagnostic ports only.

1. Consult the vehicle's owner's manual to locate the diagnostic port of the vehicle.
2. Locate the alignment pin on the WVA and diagnostic port.

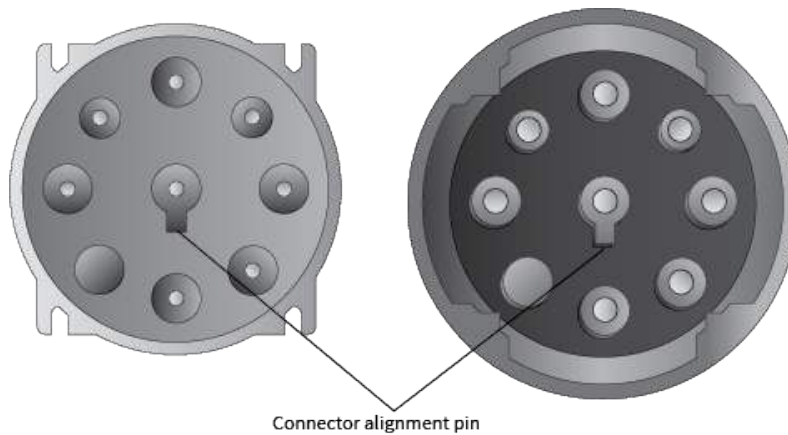

3. Connect the WVA to the diagnostic port. Twist the WVA locking ring clockwise to lock.

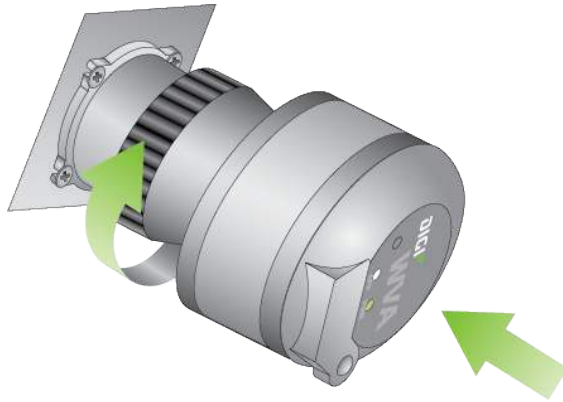

## Remove the WVA from the diagnostic port

You can remove the WVA from the diagnostic port in a vehicle.

1. Twist the WVA locking ring counterclockwise.
2. Pull the WVA from the diagnostic port.

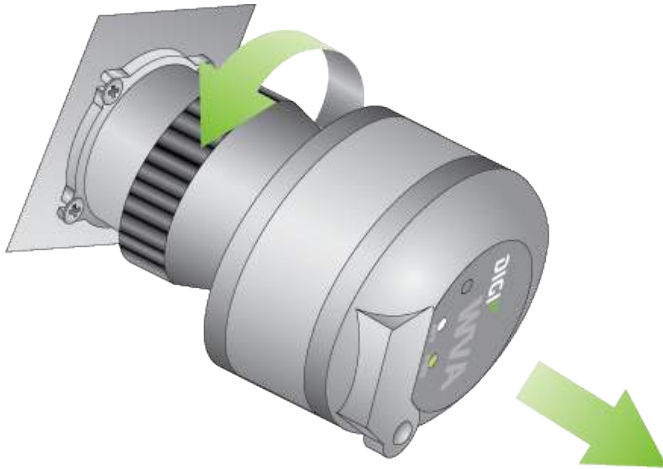

## WVA LEDs

The WVA has several LEDs on the top of the device:

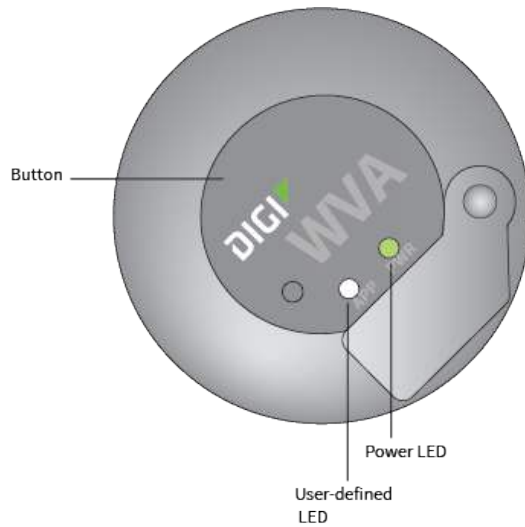

### Power LED

- **Off (dark):** No power. For more information, see [Power LED is dark](#).
- **Solid green:** The device is powered.

---

**Note** The WVA must be powered on and able to connect with a wireless network to work as expected. You can confirm that the WVA can connect to a wireless network in the **Network Connectivity Status** section in the **Device Information** page in the web interface. For more information, see [Device Information page descriptions](#).

---

- **Blinking green:** An update of the firmware for the device is in progress.

### User-defined LED

The user-defined LED allows you to set LED functionality as needed for your particular application. By default, this LED is not enabled.

For more information on programming the user-defined LED, see the [Wireless Vehicle Bus Adapter Application Developer's Guide](#).

## Connect to the WVA

---

After you have connected the WVA to a CAN simulator or plugged it into a vehicle's diagnostic port, you can connect to the WVA from a smart phone, tablet, or laptop. This enables you to configure the WVA settings, view device status, perform firmware updates, and view a log of system events.

Connect to the WVA from a smart phone or tablet .....	16
Connect to the WVA from a laptop .....	16

The WVA has several default startup and operation behaviors that should be considered in your own network's setup and operation. For more information, see [Deployment decisions](#).

---

**Note** You will need the QR code label included in the WVA packaging to connect to the WVA. Make sure you have access to this label before you begin.

---

## Connect to the WVA from a smart phone or tablet

Connecting to the WVA from a smart phone or tablet requires a QR code reader. If you do not already have a QR code reader available on your phone or tablet, download one for your mobile device or tablet. Digi recommends the QR code reader by Scan, Inc.

1. From your smart phone or tablet, download a QR Code Reader if you do not have one available.
  - a. Navigate to [www.scan.me](http://www.scan.me).
  - b. Click the **Download App** button to start the download process.
2. Set the WVA to factory defaults. Press and hold the button on the device for at least **10** seconds to return the gateway to its initial state.
3. With the QR code reader, scan the QR code label shipped with your WVA.

**SSID:** wva-00:40:9D:5C:49:98

**PASS:** AZ09azAZ09azAZ



4. A prompt appears, asking whether you want to connect to the WVA. Select **Yes**. Your device connects to the WVA access point automatically.

If you are unable to connect to the WVA, see [WVA does not connect to an access point](#).

## Connect to the WVA from a laptop

Connecting to the WVA from a laptop requires the network security key from the QR code label included in the WVA packaging.

1. Set the WVA to factory defaults before starting this procedure. Press and hold the button on the device for at least **10** seconds to return the gateway to its initial state.



2. The WVA appears in the list of available network connections as a wireless network access point. The access point has a default name derived from the serial address for the device in this format: **wva-mac-address**.

On the laptop, search the list of network connections for the access point name **wva-mac-address**. For example: wva-00:40:4d:41:88:81



3. Select the access point name and click **Connect** to connect to the WVA as a wireless access point. If you do not see the WVA in the connections list, or cannot connect to it, see [WVA does not connect to an access point](#).
4. Enter the network security key. This network security key is labeled **PASS** on the QR code label in the WVA packaging.

SSID: wva-00:40:9D:5C:49:98  
PASS: AZ09azAZ09azAZ



## Access and use the WVA web interface

---

The WVA has a web interface for configuring device settings, viewing device status, performing firmware updates, and viewing a log of system events.

See the topics below for more detailed information:

Apply and save changes .....	19
Cancel changes to configuration settings .....	19
Open the web interface .....	19
Upload a file to the WVA .....	20

## Apply and save changes

The web interface runs locally on the device, which means that the interface always maintains and displays the latest settings in the Digi device. On each screen, clicking **Apply** saves any configuration changes to the Digi device.

## Cancel changes to configuration settings

Click the **Refresh** or **Reload** button on the web browser to reload the page. Any changes made since the last time you clicked the **Apply** button are reset to their original values.

## Open the web interface

Use the WVA web interface to configure device settings, view device status and system settings, and perform firmware updates.

---

**Note** Before you can open the web interface, you must be connected to the WVA. For more information see [Connect to the WVA](#).

---

1. Go to a browser and access the web interface using the default IP address for the WVA access point: **192.168.100.1**

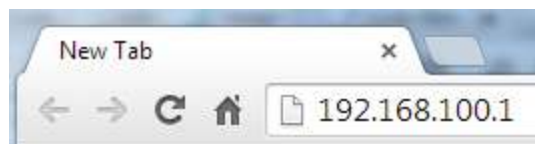

2. The first time you attempt to access the WVA, a certificate management prompt appears. Click **Proceed Anyway**.
3. A login prompt appears.
  - For **username**, enter **admin**.
  - For **password**, enter **admin**.

---

**Note** You can change the password from the default at a later time on the **Configuration > Admin Password** page.

---

4. The **Device Information** page appears. This page is also known as the **Home** page. You can return to it at any time in the interface by clicking **Home** in the menu on the left side. For information about the sections in the **Device Information** page, see [Device Information page descriptions](#).

---

**Note** If you cannot open this page for the WVA, see [Cannot open web interface or access web services](#).

---

5. You can make the configuration changes as needed by clicking a menu option in the left-hand pane. When a change is made, click **Apply** to save any changes to the WVA device. For more information, see [Apply and save changes](#).

## Upload a file to the WVA

In the **File Management** page, you can manage custom applications, their associated data files, and other files. You can also push firmware upload files to the device filesystem, pull log files from the device filesystem, and load files onto the WVA. The **File Management** page also displays current information about loaded files.

For more information about the **File Management** page, see [File Management page descriptions](#).

This process explains how to upload files to the WVA, such as a Python script.

1. Open the WVA web interface. For instructions, see [Open the web interface](#).
2. Click the **Administration > File Management** link in the WVA web interface. The **File Management** page appears.
3. Click the **Browse** button to locate the file on your computer that you want to upload to the WVA.
4. Click **Update file** to begin the file upload process.

## Configure the WVA

---

You can configure settings for the WVA in the web interface. You must first connect to the WVA. See [Connect to the WVA](#) and [Open the web interface](#) to get started.

Once you have accessed the web interface, you can configure the WVA settings. The following topics describe how to configure your WVA's wireless settings and perform other set up and management tasks.

Configure wireless settings .....	22
Configure CAN bus baud rate (CAN bus simulator use only) .....	27
Configure Python programs .....	28
Configure network services .....	30
Configure power management settings .....	31
Enable Remote Manager connectivity (optional) .....	33

## Configure wireless settings

Configure the WVA's wireless settings from the web interface to establish the wireless network method.

Choose one of the following wireless network communication methods:

- **As an access point.** Wireless communication is possible with an access point that uses the default IP address, an SSID, and a pre-shared key. The access point is always accessible at the address **192.168.100.1** when devices connect to it.
- **As a client device in a wireless network infrastructure:** You must set up this type of configuration for each type of wireless network in which you want the WVA to operate. The web interface has a wizard for configuring the WVA as a client device. By default, when the WVA connects to another access point as a client, which it can do in parallel with devices connecting to it as an access point, it gets its IP address via DHCP. IP address assignment via DHCP is enabled by default. For instructions on configuring the WVA as a client device, see [Configure WVA for Wi-Fi Infrastructure mode](#).
- **Using Wi-Fi Direct.** Wi-Fi Direct is a Wi-Fi standard that enables devices to connect easily with each other without requiring a wireless access point and to communicate at typical Wi-Fi speeds. Wi-Fi Direct requires a one-time configuration for WVA units, where you set how the WVA user establishes a Wi-Fi Direct connection: by pressing the button on the WVA, or by entering a PIN. After this configuration, users establish a Wi-Fi Direct connection by a button press or entering a PIN. In Wi-Fi Direct mode, the default IP address is **192.168.43.1** when devices connect to it. For instructions on configuring the WVA to use Wi-Fi Direct, see [Configure WVA for Wi-Fi Direct](#).



**CAUTION!** Switching the WVA to Wi-Fi Direct mode disables access point mode. This means the only way that you can access the WVA is through a device supporting Wi-Fi Direct. If you cannot access the WVA, reset the device to factory defaults. For more information, see [Reset the WVA to factory defaults](#).

---

### Configure WVA for Wi-Fi Infrastructure mode

To configure the WVA as a client device in a wireless network infrastructure:

1. [Open the web interface](#).
2. In the web interface, go to **Configuration > Wireless Network**.

3. The **Wireless Network Configuration** page appears. In the **Interface Availability Configuration** section, click **Infrastructure**.

**Wireless Network Configuration**

Current IP Parameters

Automatic address assignment via DHCP is **enabled**.

IP Address: 10.10.32.234  
Subnet Mask: 255.255.255.0  
Default Gateway: 10.10.32.1

Interface Configuration

Enable this network interface

**Infrastructure** Configure to connect to an Access Point or Hot Spot

Wi-Fi Direct Configure to connect using Wi-Fi Direct

4. The Wi-Fi Infrastructure Wizard appears.
  - a. The wizard scans for available wireless networks, and displays them in a list.

**Pick from the list, or enter a network SSID below:**

DAP-GUEST  
MJC\_NETGEAR  
SA\_TUX\_200  
linksys

Apply Refresh

- b. Click **Apply**.
5. Select the security mode and enter the associated parameters for the security mode. If you do not know these values, contact your network administrator. The default security mode for the WVA is **WPA-PSK**.

**Step 2: Select Security Mode and enter associated parameters:**

Security Mode: WPA-PSK

WPA Shared Key: [text input field]

Confirm Key: [text input field]

Click "Finish" to continue or "Cancel" to end the wizard and return to the Wireless Network Configuration page.

Finish Cancel

6. When the wizard completes, the WVA connects as a client to the wireless network you selected in step 4. The WVA gets its IP address via DHCP.

## Configure WVA for Wi-Fi Direct

To configure the WVA for access by Wi-Fi Direct:

1. [Open the web interface](#).
2. In the web interface, go to **Configuration > Wireless Network**. The **Wireless Network Configuration** page appears.
3. Under **Interface Availability Configuration**, click **Wi-Fi Direct**.





4. The Wi-Fi Direct Wizard launches. The wizard prompts you for a device name and the method for establishing the Wi-Fi Direct connection.
  - a. In the **Device Name** field, enter an identifier associated with the WVA. The recommended name is the fleet ID for the vehicle, such as **truck326**:



The screenshot shows a configuration window for the Wi-Fi Direct Wizard. It contains the following elements:

- Device Name:** A text input field containing the value "truck326".
- WPS Method:** A dropdown menu currently set to "Push Button".
- Reconfigure IP addresses for Wi-Fi Direct
- Instructional text: "Click 'Finish' to continue or 'Cancel' to end the wizard and return to the Wireless Configuration page."
- Two buttons: "Finish" and "Cancel".

- b. In the **WPS Method** field, select the Wi-Fi Protected Setup (WPS) method that Wi-Fi Direct users will use to connect to the WVA. Options are:
- **Push Button:** Configures the Wi-Fi Direct connection to be established by a user pressing the WVA button. The **Push Button** method establishes the Wi-Fi Direct connection from the phone/tablet side with no data entry required. Because most phone/tablet devices remember the connection, the connection needs to be established only once. However, users must locate the WVA in the vehicle to press the button, which can be difficult to do in some vehicles.
  - **Enter PIN:** Configures the Wi-Fi Direct connection to be established by a user entering a PIN on the connecting device (phone or tablet). Using the **Enter PIN** method eliminates the need to locate the WVA in the vehicle to press the button. However, it requires users to enter the PIN from the connecting device every time the user accesses the WVA.
  - **WPS PIN:** Selecting a value for the **WPS Method** option displays the next field, **WPS PIN**. This is the PIN users enter to establish the Wi-Fi Direct connection. This PIN is an eight-digit code. Enter the first seven digits of the PIN. The eighth digit is calculated and displayed.



The screenshot shows a configuration window for the WVA. It contains the following fields and text:

- Device Name:** truck326
- WPS Method:** Enter PIN
- WPS PIN:** 2345625

Below the fields, the text reads: "Enter the first 7 digits of the PIN. The complete PIN will be shown below." This is followed by "To connect to this device, enter this PIN on the phone or tablet:" and the displayed PIN "23456259". Below that, it says "Please record this PIN. It is required to connect to this device." At the bottom, there is a checked checkbox labeled "Reconfigure IP addresses for Wi-Fi Direct".

- Checking the **Reconfigure IP addresses for Wi-Fi Direct** checkbox forces the WVA's IP addressing to a mode that always works for Wi-Fi Direct. Digi recommends keeping this checkbox checked.
5. Click **Finish** to complete the wizard.
  6. When the wizard completes, if a reboot is required, click **Reboot** to complete the configuration. The WVA enables Wi-Fi Direct mode and is configured with a default IP address of **192.168.43.1**

**Note** The settings on the **Wireless Access Point** page are advanced settings, intended for experienced WVA users only. Take care in changing settings on that page, as they can invalidate standard Wi-Fi settings.

## Configure CAN bus baud rate (CAN bus simulator use only)

If you are using the WVA connected to a CAN simulator, you need to configure the CAN bus baud rate.



**CAUTION!** When connected to a CAN bus with multiple active devices, such as in a vehicle, the WVA can automatically select the CAN bus baud rate. However, when connected to a single device, such as the recommended CAN simulator for the WVA, specifying the baud rate is necessary to prevent a baud rate mismatch.

To configure the CAN bus baud rate, follow these steps:

1. [Open the WVA web interface](#).
2. In the web interface, go to **Configuration > CAN Bus**. There are two groups of settings for the two CAN bus interfaces.

**CAN Bus Configuration**

Current Settings

Each CAN bus may be individually configured.

**CAN Bus 1 Settings**

Enable CAN Bus

Baud Rate:

**CAN Bus 2 Settings**

Enable CAN Bus

Baud Rate:

3. In the **CAN Bus 1 Settings** section:
  - a. Verify that the **Enable CAN Bus** option is selected.
  - b. Change the **Baud Rate** setting from its default, **Auto Baud**, to **250000**.

**CAN Bus 1 Settings**

Enable CAN Bus

Baud Rate:



**CAUTION!** If any single device is set to the wrong rate, the entire CAN bus can be affected negatively.

4. If also using the second CAN bus interface, in the **CAN Bus 2 Settings** section:
  - a. Verify that the **Enable CAN Bus** option is selected.
  - b. Change the **Baud Rate** setting from its default, **Auto Baud**, to **250000**.

CAN Bus 2 Settings

Enable CAN Bus

Baud Rate: 250000

Apply

5. Click **Apply**.

## Configure Python programs

You can configure the WVA to automatically run a specified set of Python programs each time the WVA starts up and when the Python applications exit. You access the **Python Configuration** page in the WVA web interface.

To configure a new Python application in the WVA:

1. [Open the WVA web interface](#).
2. Upload the desired Python file to the WVA device from the **File Management** page. For instructions, see [Upload a file to the WVA](#).
3. In the web interface, go to **Configuration > Python**. The **Python Configuration** page appears. The page displays a list of Python processes or applications that are currently configured in the WVA. The status of each process and the action that will be executed when the Python applications exit also appears. The list is empty if no Python processes or applications have been configured.

### Python Configuration

Current Settings

Specify Python applications to run.  
Applications start or stop immediately, and start when the device is started.  
For each application, select the action to perform when the application exits.

Enable	Command Line (with optional arguments)	Active	Action On Exit
<input type="checkbox"/>	<input style="width: 90%;" type="text"/>	<input type="radio"/>	No action taken ▾
<input type="checkbox"/>	<input style="width: 90%;" type="text"/>	<input type="radio"/>	No action taken ▾
<input type="checkbox"/>	<input style="width: 90%;" type="text"/>	<input type="radio"/>	No action taken ▾
<input type="checkbox"/>	<input style="width: 90%;" type="text"/>	<input type="radio"/>	No action taken ▾

4. In the **Command Line** field, enter the name of the Python file to be configured, and any program arguments.
5. Configure the application to automatically run when the WVA device starts up by clicking the corresponding checkbox in the **Enable** column.

---

**Note** When you check this option, the Python application also runs when the configuration changes are saved.

---

6. In the corresponding **Action On Exit** combo box, select the action option that should run when the Python application exits.
  - **No action taken:** Continue device operation without doing anything about the program.
  - **Restart the application:** Restart the Python application.
  - **Reboot the device:** Reboot the WVA.
7. Click **Apply** to save the changes.
8. After a Python application has been configured, the indicators in the **Active** column change color to show the status of the Python application.
  - **Gray:** Application is not running.
  - **Green:** Application is running.

## Start or stop an already configured Python application

You can immediately start or stop a Python application that has been configured in the **Python Configuration** page in the WVA web interface.

---

**Note** You must have previously configured a Python application in the **Python Configuration** page. For instructions, see [Configure Python programs](#).

---

1. [Open the WVA web interface.](#)
2. In the web interface, go to **Configuration > Python**. The **Python Configuration** page appears.
  - **Immediately stop a Python script:** De-select the **Enable** checkbox that corresponds to the configured Python application.
  - **Immediately start a Python script:** Select the **Enable** checkbox that corresponds to the configured Python application.
3. Click **Apply** to save the changes.

## Determine whether Python applications are running

The colored indicators in the **Active** column in the **Python Configuration** page in the WVA web interface indicate whether the corresponding application is running.

---

**Note** You must have previously configured a Python application in the **Python Configuration** page. For instructions, see [Configure Python programs](#).

---

1. [Open the WVA web interface.](#)
2. In the web interface, go to **Configuration > Python**. The **Python Configuration** page appears.
3. View the indicator in the **Active** column for each configured Python application:
  - **Green:** Application is running.
  - **Gray:** Application is not running.

## Configure network services

You can configure network services in the **Network Service Configuration** page in the WVA web interface. Settings on this page enable or disable common network services on the WVA, and configure the network port on which the service is listening. You can disable network services to improve device security, so the device runs only specifically needed network services.

1. [Open the WVA web interface.](#)
2. In the web interface, go to **Configuration > Network Services** to display the **Network Services** page.

**Network Service Configuration**

Current Settings

**Secure Shell (SSH)**  
Allows users secure access to log in to the Digi device and access the command-line interface.

Enable Secure Shell Server (SSH) TCP Port:

**WEB Server (HTTP)**  
Web pages for configuration.

Enable Web Server (HTTP) TCP Port:

**Secure WEB Server (HTTPS)**  
Web pages encryption to improve the security of web data transfers.

Enable Secure Web Server (HTTPS) TCP Port:

Web services event channel for use by applications.

Enable Web Services Events TCP Port:

**Device Discovery Service (ADDP)**  
Discovery of Digi devices on a network using Digi Device Discovery application.

Device Discovery Service (ADDP) Mode:  **Read-Only:** Allows discovery of devices.  
**Read-Write:** (default) Allows discovery and network configuration.  
**Off:** Disables service entirely.

3. Enable/disable the network services as needed. See [Network Service Configuration page descriptions](#) for more information about each service and its default TCP port number. It is usually best to use the default TCP port numbers for these services because they are well-known by most applications.
4. Click **Apply**.

## Configure power management settings

You can configure power management settings in the **Power Management Configuration** page in the WVA web interface. With these settings, you can control whether the WVA powers down once it has been determined that the vehicle is not running, and choose from a variety of mechanisms for waking the WVA again. For more detailed information, see [About power management](#).

To configure power management using the web interface:

1. [Open the WVA web interface](#).
2. In the web interface, go to **Configuration > Power Management**. The **Power Management Configuration** page appears.

3. The power management service is disabled by default. To enable it, check the **Enable Power Management** checkbox:

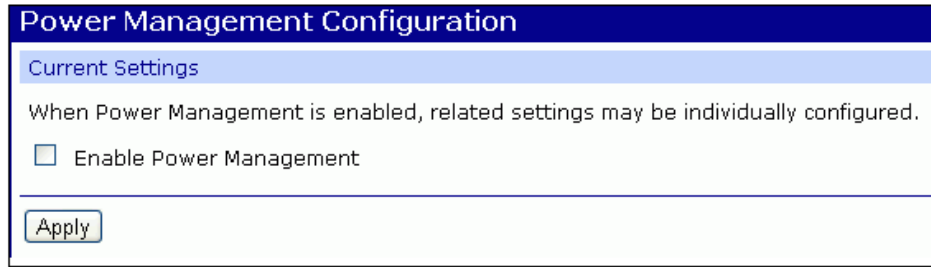

The screenshot shows a dialog box titled "Power Management Configuration". Under the "Current Settings" section, there is a text label: "When Power Management is enabled, related settings may be individually configured." Below this is a checkbox labeled "Enable Power Management" which is currently unchecked. At the bottom of the dialog is an "Apply" button.

When **Power Management** is enabled, all the Power Management settings appear:

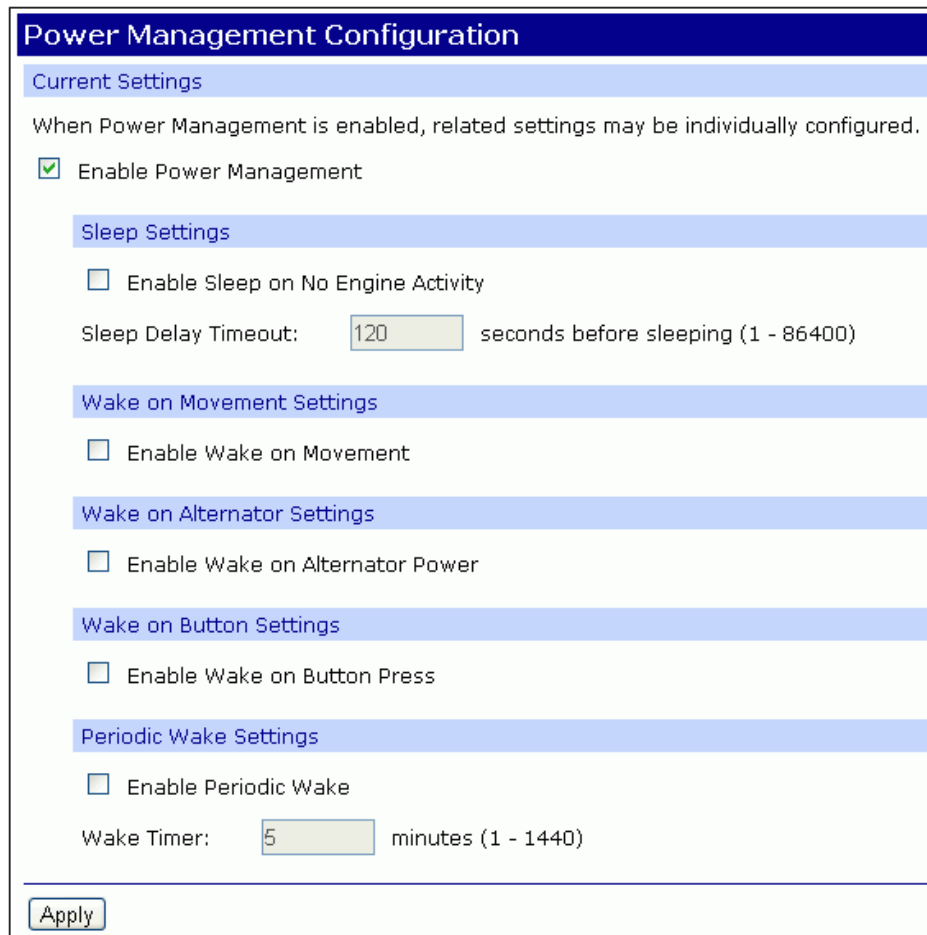

The screenshot shows the "Power Management Configuration" dialog box with "Enable Power Management" checked. The following settings are visible and unchecked:

- Sleep Settings**
  - Enable Sleep on No Engine Activity
  - Sleep Delay Timeout: 120 seconds before sleeping (1 - 86400)
- Wake on Movement Settings**
  - Enable Wake on Movement
- Wake on Alternator Settings**
  - Enable Wake on Alternator Power
- Wake on Button Settings**
  - Enable Wake on Button Press
- Periodic Wake Settings**
  - Enable Periodic Wake
  - Wake Timer: 5 minutes (1 - 1440)

An "Apply" button is located at the bottom of the dialog.

4. View and change the power management settings as needed. See [Power Management Configuration page descriptions](#) for information about the settings and defined defaults.
5. Click **Apply** to save the changes.



## About power management

The WVA has a configurable power management service. You can use the power management settings to control whether the WVA powers down ("sleeps") when the vehicle is not running, and choose from a variety of mechanisms for waking the WVA again. During the time the WVA is sleeping, its power consumption is dramatically reduced, which prevents the device from draining the vehicle battery.

When you enable power management, the WVA detects that the engine is not running, then waits a specified amount of time and goes to sleep. The specified time is configurable and can be delayed if there is an important operation on the vehicle. Instances where a delay would be desirable include:

- To allow a web services-based application to interact with the device (and, in a sense, the vehicle) for a certain period of time after no engine activity.
- To reduce the latency involved in responsiveness while the WVA boots if the vehicle is only shut off for a brief period. For example, if the vehicle were turned off and then back on quickly, such a delay could cause the WVA to avoid its own boot time by simply staying awake.

You can configure the WVA to wake under one or more of the following conditions:

- When a configurable timer expires.
- When the alternator is generating power.
- When the WVA detects sufficient vibration; for instance, slamming the driver door or starting the engine.
- When a user presses the WVA button.

The power management service is integrated with the standard device settings. There are two ways to configure these settings:

- Using the settings on the **Power Management Configuration** page. See [Configure power management settings](#).
- Through the WVA web services. See [Wireless Vehicle Bus Adapter Application Developer's Guide](#) for more information on web services.

## Enable Remote Manager connectivity (optional)

By default, the connectivity of the WVA device to Remote Manager for remote device management is disabled.

Digi Remote Manager® connectivity is typically only available when the WVA is in Infrastructure mode, operating as a Wi-Fi client, and the device acting as the access point for the WVA forwards traffic to the Internet.

---

**Note** To serve our customers most effectively, Digi International Inc. is consolidating its cloud services, Digi Device Cloud and Digi Remote Manager®, under the Remote Manager name. This phased process does not affect device functionality or the functionality of the web services and other features. However, you will find instances of both Device Cloud and Digi Remote Manager in some documentation, firmware, and user interfaces.

---

To enable Remote Manager connectivity:

1. If enabling Remote Manager, you must set the WVA real-time clock through web services. See [Default behavior regarding time](#). An example of setting time via web services is included in the WVA demo application.

2. [Open the WVA web interface.](#)
3. In the web interface, go to **Configuration > Device Cloud Connectivity**. The **Device Cloud Configuration** page displays.
4. Select the **Enable Device Cloud Connectivity** option. Do not change the default values in the dialog.
5. Click **Apply**.
6. When Remote Manager connectivity is enabled, several network connection states are added to the **Network Connectivity Status** list on the **Device Information** page. For descriptions of each option, see [Device Information page descriptions](#).

## Manage the WVA device

---

The topics in this section explain how to manage the WVA devices.

Rediscover the WVA .....	36
Reboot the WVA .....	37
Reset the WVA to factory defaults .....	37
Disable and enable the factory reset button .....	37
WVA filesystem and file management .....	37
View the system log .....	38
View status information .....	42

## Rediscover the WVA

To determine the IP address of a WVA connected to a network in Infrastructure mode, you can use the Digi Device Discovery Utility to rediscover the device.

1. Download the Digi Device Discovery Utility.
  - a. Access the [WVA Support Services page](#).
  - b. Scroll down to the **Support Downloads** section.
  - c. Click **Diagnostics, Utilities & MIBS** to expand that section of the page.
  - d. Search for "Wireless Vehicle Bus Adapter".
  - e. Click the **Wireless Vehicle Bus Adapter** option when it appear in the **All Products** window. The Wireless Vehicle Bus Adapter (WVA) product support page appears.
  - f. From the **Operating System Specific Utilities** list box in the **Diagnostics, Utilities & MIBS** section, select your operating system. A list of options appears in the **Operating System Specific Diagnostics, Utilities and MIBs** section.
  - g. Click on the desired option to download the utility.
2. Run the Digi Device Discovery Utility from your PC's Start Menu: **Start > Digi > Digi Device Discovery > Digi Device Discovery**. The Digi Device Discovery window appears.

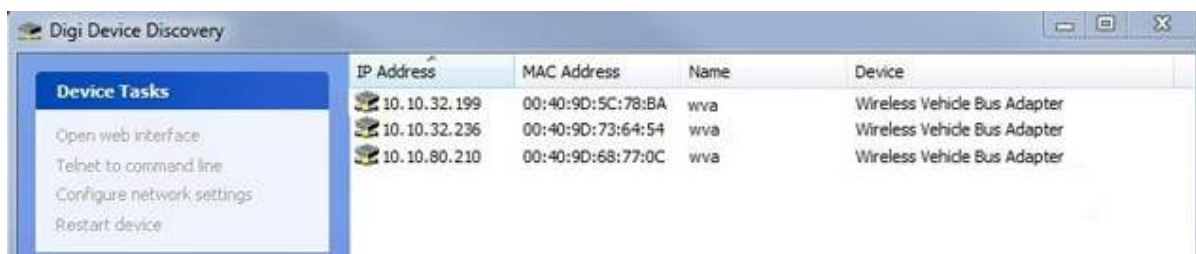

3. In the Digi Device Discovery device list, locate your WVA in the list of devices by matching the **MAC Address** on your WVA label to the corresponding value in the **MAC Address** column.

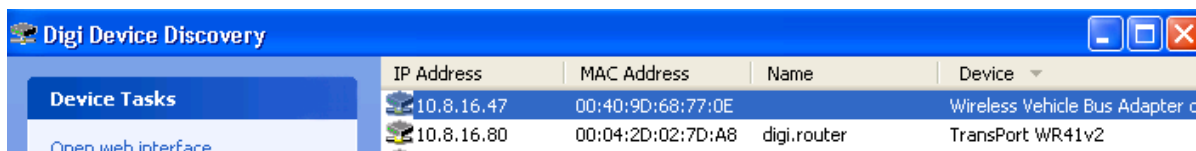

4. Use one of the following methods to open the web interface for the device:
  - Double-click the device.
  - Select the device, and choose **Open web interface** from the **Device tasks** section.

## Reboot the WVA

You can reboot the WVA device from the WVA web interface.

You may need to reboot the WVA if you have lost your network connection and are unable to reconnect to the network. When you reboot, you will lose any CAN traffic information that occurs during the reboot process.

1. [Open the WVA web interface](#).
2. In the **Device Information** (Home) page, choose **Administration > Reboot**.

## Reset the WVA to factory defaults

In some situations, you may need to reset the WVA to factory defaults. For example, if you [reboot the WVA](#) and it doesn't recover, you can reset the WVA to force it to recover.

A factory reset clears all custom configuration settings since the device was last reset. After the reboot, you must reenter and reapply any configuration settings unique to your device.

To reset the WVA to factory defaults, press and hold the button on the top of the WVA for **10** seconds.

---

**Note** You can disable the factory reset by button press, if needed. For instructions, see [Disable and enable the factory reset button](#).

---

## Disable and enable the factory reset button

If desired, you can disable the factory reset by button press. Once you have disabled this feature, you will not be able to [reset the WVA](#) to factory defaults. You can re-establish this feature by enabling the factory reset button.

You can use the WVA web services configuration resource **config/button** to disable and enable the factory reset button.

See the description of this resource in the [Wireless Vehicle Bus Adapter \(WVA\) Application Developer Guide](#).

### Disable the factory reset button

Set the **config/button** resource to "none" to disable.

---

```
<button>
<reset_to_factory>none</reset_to_factory>
</button>
```

---

### Enable the factory reset button

Set the **config/button** resource to "default" to re-enable.

---

```
<button>
<reset_to_factory>default</reset_to_factory>
</button>
```

---

## WVA filesystem and file management

The WVA has a Linux-based filesystem.

Two directory folders are available:

- The **/WEB/python/** directory is for user-specific files, such as custom applications. This area is read-write and you can add additional files as needed for your application.
- The **/WEB/logging** directory is read-only and contains system log files, including **eventlog.txt**, **python.log**, and **digi.log**. For more information on these files, see [View the system log](#).

For more information on the filesystem, see the [Filesystem interfaces](#) topic in the *Wireless Vehicle Bus Adapter (WVA) Application Developer Guide*.

## Access/Browse the filesystem from device interfaces

There are several ways in which you can interact with the filesystem on the WVA:

- **File Management** page in the web interface. See [File Management page descriptions](#).
- Remote Manager File Management functions. See [Enable Remote Manager connectivity \(optional\)](#).
- Web services filesystem interfaces. These resources are used to browse and create directories and manipulate files. See [Configure network services](#).
- The web interface when performing several operations, including firmware updates and backup/restore operations. See [WVA web interface page descriptions](#).

## View the system log

The **System Message Log File Browser** in the WVA web interface is a diagnostic tool that allows you to view entries in a system log file. The default log file that you can view from this browser is eventlog.txt. This file is the primary message log for informational notices.

Logging is always enabled and is not user-configurable. When the WVA operates in an unexpected manner, the log entries can be sent to Digi for analysis by Technical Support and Engineers. The event log cannot be turned off, to ensure that Digi receives an accurate view of all aspects of the operation of the device.

## Device Configuration and Management

### Wireless Vehicle Bus Adapter

**System Message Log File Browser**

Log File

Select Log File: eventlog.txt ▾ Get File

Message Filters for Displayed Log File

security audit     system  
Clear All Mark All

Messages in Log File "eventlog.txt"

Refresh Save All

Oct 23 17:57:13: System: Start
Oct 23 17:59:03: System: Start
Oct 23 18:01:49: System: Start
Oct 24 12:14:20: System: Start
Oct 24 12:19:07: System: Start
Oct 27 16:00:51: System: Start
Oct 27 17:05:38: System: Start
Oct 27 17:52:12: System: Start
Oct 28 20:09:26: System: Start

Refresh Save All

### Log files and contents

There are other system log files that are available for debugging specific parts of the system. These log files have a fixed size and roll over when the maximum size is reached. When the file rolls over, a single secondary file is created with the extension **.0** . For example, when eventlog.txt rolls over, the older data will be stored in file eventlog.txt.0. When both files reach their maximum size, the older file is overwritten.

Many of the log files are stored in persistent memory (flash) and contain data from multiple boots.

Log file	Contents
eventlog.txt eventlog.txt.0	High-level system messages.

Log file	Contents
python.log python.log.0	Captures any output of Python programs that were started with the Python auto-start feature.
digi.log digi.log.0	For internal use only. Digi Technical Support may request that you send this file when assisting you with troubleshooting.
messages.log messages.log.0	For internal use only.
cherokee.log cherokee.log.0	For internal use only.

The options in the **Message Filters for Displayed Log File** section allow Digi Technical Support working with customers on troubleshooting issues to more quickly focus on areas of interest in the log file as needed.

To view these other log files in the **System Message Log File Browser** page, enter the file name in the field below Log File and click **Get File**. Or, or select **Other log**; enter the desired log file, and click **Get File**. The following example shows digi.log being selected and the messages in digi.log.

Note that digi.log involves several more message filters:



### System Message Log File Browser

Log File

Select Log File: digi.log Get File

Message Filters for Displayed Log File

<input checked="" type="checkbox"/> addpd	<input checked="" type="checkbox"/> build_resolv_conf	<input checked="" type="checkbox"/> buzzerctl	<input checked="" type="checkbox"/> checkpic
<input checked="" type="checkbox"/> defs_prune	<input checked="" type="checkbox"/> digicsd	<input checked="" type="checkbox"/> dropbear	<input checked="" type="checkbox"/> entropy
<input checked="" type="checkbox"/> generate	<input checked="" type="checkbox"/> generate_addpd_conf	<input checked="" type="checkbox"/> generate_autoip	<input checked="" type="checkbox"/> generate_basic_power_conf
<input checked="" type="checkbox"/> start_stunnel	<input checked="" type="checkbox"/> stunnel	<input checked="" type="checkbox"/> udhcpc	<input checked="" type="checkbox"/> vbused
<input checked="" type="checkbox"/> watchdog	<input checked="" type="checkbox"/> web_service	<input checked="" type="checkbox"/> wificfgctl	

Clear All Mark All

Messages in Log File "digi.log"

Refresh Save All

```

Oct 23 17:57:13 kern.info kernel:imklog 6.2.1, log source = /proc/kmsg started.
Oct 24 12:41:01 local5.info vbused[6757]: vbused engine ready
Oct 24 12:41:21 local5.info digicsd[1028]: Validation of RCI set_setting request successful
Oct 24 12:41:21 local5.info digicsd[1028]: Config write successful
Oct 24 12:41:21 local5.info digicsd[988]: Parent poll returned 1, 1.
Oct 24 12:41:21 local5.info digicsd[988]: Parent read returned 1 'g'
Oct 24 12:41:21 local5.info digicsd[988]: Parent received 'g'.
Oct 24 12:41:27 local5.info generate: Processing changes to configuration database
Oct 24 12:41:27 local5.info generate_canbus_conf: Generated /etc/canbus.conf
Oct 24 12:41:29 user.notice root: Setting can0 bitrate 250000
Oct 24 12:41:30 user.notice root: Setting can1 bitrate 250000
Oct 24 12:41:30 local5.info generate: Activated settings changes (generate_canbus_conf)
Oct 24 12:41:30 local5.info vbused[6951]: starting
Oct 24 12:41:30 local5.notice vbused[6951]: setting user to vbused
Oct 24 12:41:30 local5.info vbused[6951]: vbused engine ready
Oct 24 12:41:30 local5.info digicsd[988]: generate succeeded with return value 0, exit status 0
Oct 24 12:42:34 local5.notice vbused[6951]: creating non-volatile ECU list
Oct 24 12:42:40 local5.notice guardd[997]: scheduling script restart_vbus because process vbused died
Oct 24 12:42:40 local5.notice guardd[997]: Restarting vbused
Oct 24 12:42:43 user.notice root: Setting can0 bitrate 250000
Oct 24 12:42:43 user.notice root: Setting can1 bitrate 250000
Oct 24 12:42:44 local5.info vbused[7368]: starting
Oct 24 12:42:44 local5.notice vbused[7368]: setting user to vbused
Oct 24 12:42:44 local5.info vbused[7368]: vbused engine ready
Oct 24 14:06:24 local5.info addpd[936]: model=Wireless Vehicle Bus Adapter
Oct 24 14:06:24 local5.info addpd[936]: firmwareversion=3.2.10.4
Oct 24 14:06:24 local5.info addpd[936]: deviceid=00000000-00000000-00409dff-ff736454
Oct 24 14:07:27 local5.info addpd[936]: model=Wireless Vehicle Bus Adapter
Oct 24 14:07:27 local5.info addpd[936]: firmwareversion=3.2.10.4
Oct 24 14:07:27 local5.info addpd[936]: deviceid=00000000-00000000-00409dff-ff736454
    
```

## View status information

Several pages in the WVA web interface indicate device status information.

- **Network Connectivity Status** section in the **Device Information** (Home) page. For detailed information, see [Device Information page descriptions](#).
- **Adapter Status** page. This page includes information about the wireless network and vehicle status. Choose **Administration > Adapter Status** to display the page. For detailed information about the options in this page, see [Adapter Status page descriptions](#).

## Deployment decisions

---

The WVA has several default startup and operation behaviors to be considered in your own network's setup and operation. If these behaviors present any conflicts with your network's configuration and operation, you may need to make adjustments to the WVA or the network.

### Default behavior regarding time

The WVA has a real-time clock. This clock must be set using the web services interface resource **hw/time** by the connected device (phone, tablet, PC). See the description of the **hw/time** resource in the [Wireless Vehicle Bus Application Developer's Guide](#).

For information about accessing the web services interface, see [Access and navigate the web services](#) section in the [Wireless Vehicle Bus Application Developer's Guide](#).

When disconnected from a power source, either in a desktop environment or a vehicle's diagnostic port, the real time clock keeps its time for two hours. After that point, the time is lost and the real time clock must be reset.

As long as the WVA is installed in the vehicle, you can assume the WVA clock is accurate. Once the WVA is disconnected from the vehicle and not powered by any other source, some drift in the time can occur.

Note that in any application code developed for the WVA, the system time must be set by the **hw/time** resource before any firmware update operations.

### Default behavior regarding Wi-Fi network connectivity

To ensure that you can easily connect to the WVA device during initial configuration, the WVA Wi-Fi is temporarily in access point mode.

The SSID for the WVA access point is **wva-mac-address**. It is strongly recommended that the WVA be configured to communicate in your local wireless network. See [Configure wireless settings](#).

### Default behavior regarding Remote Manager connectivity

The WVA's connection to Remote Manager is disabled by default. You can enable Remote Manager if needed. For more information, see [Enable Remote Manager connectivity \(optional\)](#).

### Default behavior regarding IP address assignment

IP addresses that the WVA uses depend on the network type:

- **IP address of the Wi-Fi access point interface:** The access point is accessible at the address **192.168.100.1** when the WVA is in [Infrastructure mode](#).

- **IP address of the Wi-Fi client interface:** By default, when the WVA connects out to another access point in [Infrastructure mode](#), it gets its IP address via DHCP. The WVA can do this in parallel with devices connecting to it as an access point. The IP address assignment via DHCP is enabled by default.
- **IP address in Wi-Fi Direct mode:** The default IP address in [Wi-Fi Direct mode](#) is **192.168.43.1**.

## WVA web interface page descriptions

---

You can find information about the options in the WVA web interface pages in this section.

Adapter Status page descriptions .....	46
CAN Bus page descriptions .....	47
Device Information page descriptions .....	47
File Management page descriptions .....	49
Network Service Configuration page descriptions .....	50
Power Management Configuration page descriptions .....	51
Python Configuration page descriptions .....	52

## Adapter Status page descriptions

You can view information about the wireless network and vehicle status in the **Adapter Status** page. The following table describes each of the options in the **Adapter Status** page.

### Current Wireless Networks Status section

The items in this section show the status of the wireless connection.

Status field	Description
<b>Configured SSID</b>	The configured wireless network access point for the device.
<b>Active SSID</b>	The active wireless network access point being used by the device.
<b>Access Point</b>	If the WVA is currently connected to a wireless network access point, this field contains the MAC address of the access point to which the WVA is connected.
<b>Signal Level</b>	The average power measurement of frames that the WVA receives from the access point, in dBm. See <a href="#">Wireless signal strength issues</a> for troubleshooting information. <ul style="list-style-type: none"> <li>■ <b>Excellent:</b> A signal level from <b>-40</b> to <b>-30</b> dBm.</li> <li>■ <b>Good:</b> A signal level from <b>-60</b> to <b>-70</b> dBm is good.</li> <li>■ <b>Poor:</b> Any signal level lower than <b>-75</b> dBm.</li> </ul>
<b>Link Quality</b>	An indicator of the quality of the wireless signal, taking into account background noise. Link quality is usually displayed as a fraction with <b>70</b> being the denominator; for example, <b>47/70</b> . The larger the numerator, the better the signal. A signal quality of <b>70/70</b> indicates a perfect signal, while <b>10/70</b> indicates a poor one.

### Current Vehicle Status section

This section includes status items about the vehicle or simulated vehicle to which the WVA is connected. These values are set when the page appears and are not dynamically updated.

Status field	Description
<b>VIN</b>	Vehicle identification number.
<b>Engine Speed</b>	The current speed of the vehicle's engine, in RPM.
<b>Vehicle Speed</b>	The current speed of the vehicle, in KPH.
<b>CAN Bus Statistics</b>	The number of bytes/packets sent and received from each CAN bus. This section of the status display should be updating while the vehicle is running. You can use this section to verify that the connection from the WVA to the CAN bus is correct.

Status field	Description
<b>Refresh Once</b>	Click <b>Refresh Once</b> to immediately update the status information in the screen.
<b>Refresh Automatically</b>	Click <b>Refresh Automatically</b> to automatically update the status information in the screen every 5 seconds.

### Wireless Vehicle Adapter Status

Current Wireless Network Status

Active SSID: SA\_TUX\_200  
Access Point: C0:C1:C0:DE:EE:9D  
Signal Level: -29 dBm  
Link Quality: 70/70

Current Vehicle Status

VIN: N/A  
Engine Speed: 3614.250 rpm  
Vehicle Speed: 112.938 km/h

---

Automatic refresh requests a status update every 5 seconds.

## CAN Bus page descriptions

The following table describes each of the sections in the **CAN Bus** page. You can configure up to two CAN bus devices. The options in each section are the same.

For configuration information, see [Configure CAN bus baud rate \(CAN bus simulator use only\)](#).

**Note** For vehicle use, the baud rate should always be **Auto Baud**, which is the default.

Item	Description
<b>Enable CAN Bus</b>	Select this option if you are using a CAN bus device.
<b>Baud Rate</b>	Select the correct baud rate. <ul style="list-style-type: none"> <li>■ <b>Auto Baud</b>: This is the default. For vehicle use, the baud rate should always be <b>Auto Baud</b>.</li> <li>■ <b>250000</b>: Select this option if you are using a CAN bus device.</li> </ul>

## Device Information page descriptions

The following table describes each of the sections in the **Device Information** (Home) page.

For more information about this page, see [Open the web interface](#).

Item	Description
<b>Home</b> link	Click <b>Home</b> in the menu on the left side to return to the <b>Device Information</b> page.
<b>Current System Status</b>	Summarizes current system parameters and network connectivity status.
<b>Network Connectivity Status</b>	Indicates the readiness of the WVA to communicate in a wireless network using a colored indicator. Options are: <ul style="list-style-type: none"> <li>■ Orange: Not ready</li> <li>■ Green: Ready</li> </ul>
<b>Refresh</b> button	Click <b>Refresh</b> to refresh the information on the page.
<b>Configuration</b> menu	Displays pages for configuring settings for various features. Some configuration settings are organized on sets of linked screens. The choices in this menu may vary based on product and supported features.
<b>Administration</b> menu	Displays pages for common device administration tasks.

The **Network Connectivity Status** bar display includes a list of status indicators.

If Remote Manager connectivity is not enabled, the status conditions are as follows:



If Remote Manager connectivity is enabled, the status conditions are as follows:





**Note** For information about enabling Remote Manager connectivity, see [Enable Remote Manager connectivity \(optional\)](#).

Status field	Description
<b>Network interface detected</b>	Wi-Fi AP or Ad-Hoc network detected. Connecting to Wi-Fi. Waiting for association.
<b>Connected to local network</b>	Connected to Wi-Fi. Establishing LAN connection. Waiting for IP address.
<b>IP address assigned</b>	An IP address has been assigned to the gateway. Connected to Wi-Fi network.
<b>Prepared to contact Device Cloud server</b>	The device is waiting for Remote Manager service to take control, and for DNS resolution of server chosen by the Remote Manager service; that is, the server specified in the <b>Configuration &gt; Device Cloud Connectivity</b> settings, in the <b>Device Cloud Server</b> field.
<b>Contacted Device Cloud server</b>	The device is establishing a Remote Manager connection. It is waiting for protocol level “connection” with the Remote Manager server, which might include authentication.
<b>Ready for Device Cloud communication</b>	The device is connected to the Remote Manager server.

## File Management page descriptions

The following table describes each of the sections in the **File Management** page.

Item	Description
<b>Volume information</b>	Displays the current directory for loading files and free space remaining. Digi recommends using no more than <b>20 MB</b> for custom applications, as the WVA requires a portion of the same space to be capable of managing persistent system logs and firmware updates.
<b>Upload to Current Directory</b>	Uploads files to the current directory. Use the <b>Browse</b> button to find a file on your computer to be uploaded to the WVA. Click <b>Update</b> file to begin the file upload process. For more information, see <a href="#">Upload a file to the WVA</a> .
<b>File List</b>	A listing of the “current directory” (as noted in the <b>Volume Information</b> area) on the device.
<b>Open</b>	Opens a directory after it is selected in the file list. The “current directory” changes and the file list is updated.
<b>Make Directory</b>	Creates a new, empty directory in the “current directory.”
<b>Save As</b>	Downloads a regular file from the filesystem to your local PC.

Item	Description
<b>Remove</b>	Select a file or an empty directory and click <b>Remove</b> to delete the file or directory.
<b>Refresh</b>	Click <b>Refresh</b> to reload all the information on the page.

## Network Service Configuration page descriptions

The following table describes each of the sections in the **Network Service Configuration** page. For information about configuring this page, see [Configure network services](#).

Network Service setting	Services provided	Default TCP port number
Enable Secure Shell Server (SSH)	Reserved for remote device access by Digi personnel for debugging purposes.	22
Enable Web Server (HTTP)	HyperText Transfer Protocol (HTTP), also known as Web Server. HTTP provides access to web pages for configuration and web services. HTTP and HTTPS are also referred to as Web Server or Secure Web Server. These services control the use of the web interface. If HTTP and HTTPS are disabled, device users cannot use the web interface to configure, monitor, and administer the device.	80
Enable Secure Web Server (HTTPS)	HyperText Transfer Protocol over Secure Socket Layer (HTTPS), also known as Secure Web Server. HTTPS uses encryption to improve the security of web data transfers. <div style="border: 1px solid black; padding: 5px; margin-top: 10px;"> <p><b>Secure WEB Server (HTTPS)</b></p> <p><i>Web pages encryption to improve the security of web data transfers.</i></p> <p><input checked="" type="checkbox"/> Enable Secure Web Server (HTTPS)      TCP Port: <input type="text" value="443"/></p> <p><i>Web services event channel for use by applications.</i></p> <p><input checked="" type="checkbox"/> Enable Web Services Events      TCP Port: <input type="text" value="5000"/></p> </div>	443

Network Service setting	Services provided	Default TCP port number
Enable Web Services Events	<p>In the web services, the Event Channel is the mechanism for delivering asynchronous, out-of-band data, such as alarms and periodic updates from subscriptions to vehicle data endpoints. For more information about the web services, see the <a href="#">Wireless Vehicle Bus Adapter Application Developer Guide</a>.</p> <p>This setting is disabled by default. Set the port number to a value between <b>1025</b> and <b>65535</b> that is not already assigned to another service. The example below shows the TCP port being set to <b>5000</b>, which is the TCP port number set in the WVA demo application.</p> <div data-bbox="467 627 1263 877" style="border: 1px solid black; padding: 5px;"> <p><b>Secure WEB Server (HTTPS)</b>  <i>Web pages encryption to improve the security of web data transfers.</i></p> <p><input checked="" type="checkbox"/> Enable Secure Web Server (HTTPS)      TCP Port: <input type="text" value="443"/></p> <hr/> <p><i>Web services event channel for use by applications.</i></p> <p><input checked="" type="checkbox"/> Enable Web Services Events      TCP Port: <input type="text" value="5000"/></p> </div>	0
Advanced Device Discovery Protocol (ADDP) Mode	<p>Digi's Advanced Device Discovery Protocol allows devices to be found on a network, regardless of protocol. You can also use ADDP to change network settings, or disable the service completely. There are three settings for this network service:</p> <ul style="list-style-type: none"> <li>■ <b>Read-Write:</b> Allows discovery of devices and the ability to change network settings. This is the default setting.</li> <li>■ <b>Read-Only:</b> Allows discovery of devices only.</li> <li>■ <b>Off:</b> Turns off the ADDP network service. This setting completely closes the network port used for device discovery.</li> </ul>	

## Power Management Configuration page descriptions

The following table describes each of the options in the **Power Management Configuration** page. For more information about configuring power management settings, see [Configure power management settings](#).

Section	Option	Description
Current Settings	<b>Enable Power Management</b>	Enables the Power Management feature and displays all Power Management settings.

Section	Option	Description
Sleep Settings	<b>Enable Sleep on No Engine Activity</b>	Enables or disables the WVA going into sleep mode when no engine activity (RPM=0) is detected. The default is <b>disabled (off)</b> .
	<b>Sleep Delay Timeout: n seconds before sleeping</b>	The number of seconds the WVA should wait before going to sleep when there is no engine activity detected. The default is <b>120</b> seconds.
Wake on Movement Settings	<b>Enable Wake on Movement</b>	Enables or disables the WVA waking upon detection of vibration, typically a sharp vibration to the vehicle frame. The default is disabled (off).
Wake on Alternator Settings	<b>Enable Wake on Alternator Power</b>	Enables or disables the WVA waking from sleep mode upon detection of the alternator running on alternator power rather than the vehicle battery. The default is <b>disabled (off)</b> .
Wake on Button Settings	<b>Enable Wake on Button Press</b>	Enables or disables waking from sleep mode by a button press. The default is <b>disabled (off)</b> .  <b>Note</b> The button press should be momentary and not a press-and-hold, which could cause the unit to reset to factory defaults.
Periodic Wake Settings	<b>Enable Periodic Wake</b>	Enables or disables periodic or timed wake from sleep mode for the device. The default is <b>disabled (off)</b> .
	<b>Wake Timer</b>	The time, in minutes, for the sleeping WVA to wait before waking. The time can range from <b>1</b> to <b>1440</b> minutes ( <b>24</b> hours). The default, if enabled, is <b>5</b> minutes.

## Python Configuration page descriptions

The following table describes each of the sections in the **Python Configuration** page.

For more information about configuring Python applications, see [Configure Python programs](#).

Item	Description
<b>Enable</b>	Click the check box in the <b>Enable</b> column for the Python application that should run when the WVA device starts up. When you check this option, the Python application also runs when the configuration changes are saved.

Item	Description
<b>Command Line</b>	The Python application name and any arguments.
<b>Active</b>	The indicators in the <b>Active</b> column change color to show the status of the Python application. <ul style="list-style-type: none"><li>■ <b>Gray</b>: Application is not running.</li><li>■ <b>Green</b>: Application is running.</li></ul>
<b>Action On Exit</b>	The action option that should run when the Python application exits. Options are: <ul style="list-style-type: none"><li>■ <b>No action taken</b>: Continue device operation without doing anything about the program.</li><li>■ <b>Restart the application</b>: Restart the Python application.</li><li>■ <b>Reboot the device</b>: Reboot the WVA.</li></ul>

## Run the WVA demo application

---

Digi provides a demo Android application for the WVA that demonstrates several capabilities available in the WVA and its software.

### Get started

Use the topics below to get started using the demo application:

- [Download the demo application](#)
- [Start the demo application and discover WVA devices](#)
- [Connect to the WVA](#)
- [Review the demo application dashboard](#)

### Learn the demo application software features

After you have connected the demo application to a WVA, you can learn how to use the software features:

- View a live graph view of vehicle speed and engine RPMs. See [Show graph view](#).
- Use the Event Channel to deliver alarms and notifications about the alarms and other events to the demo application. See [Configure endpoints: subscriptions and alarms](#).
- Configure the demo application settings. See [Change application settings](#).

### Build your own application

Digi created the demo application using the WVA Android library. For information on building your own application with this library, see the [WVA Android Library Tutorial](#), available from the **Documentation** section in the [WVA support page](#).

### Download the demo application

1. Navigate to the [WVA Product Support page](#).
2. Scroll to the **Software** section and click **Demo Application: WVA Sample Application, Android**. The demo application is in a **.apk** file, and downloads automatically.

3. Install the **.apk** file on the Android device.

There are three installation scenarios:

**Install the .apk file from an Android device:**

Transfer the **.apk** file to the Android device via email or USB drive.

**Install the .apk file from a Non-Android device:**

- a. Save the **.apk** file locally.
- b. Transfer the **.apk** file to the Android device via email or USB drive.

**Install the .apk file from the Android OS:**

- a. Open the **.apk** file. When downloading directly from an Android device, you can skip this step.
  - b. Follow installation instructions on the screen.
4. Once the **.apk** file is on the Android device, follow the device's standard process for installing the **.apk** file.

---

**Note** Your security settings on the Android device may block installations of applications that are not from the Google play store. You may need to modify your security settings to run the application.

---

When the application installation completes, there are two choices: **Done** and **Open**.

- Click **Open** to start the application immediately. See [Start the demo application and discover WVA devices](#) for more information.
- Click **Done** to close the application.
- To launch the application later, navigate to the Android device's Home screen, then to the application drawer, and click the WVA application icon:



## Start the demo application and discover WVA devices

After you have installed the demo application, you can run it.

1. Before you run the demo application, verify that the device is connected to the WVA. For data to be displayed in the WVA demo application, the WVA must be connected to a CAN simulator or connected to an actual vehicle bus, as described in [Connect the hardware](#).
2. Navigate to the Android device's Home screen.
3. Navigate to the Android device's application drawer.
4. Click the WVA application icon:



## Discover the WVA

The first time the WVA demo application is launched, it automatically performs a discovery of all devices on your local network that are discoverable through a Digi-proprietary protocol called ADDP. This is the same type of discovery operation performed in [Rediscover the WVA](#). The discovery operation is indicated by the progress spinner on the screen and action bar. For more information on how the WVA uses ADDP, see the [WVA Android Library Tutorial](#) and accompanying ADDP information.

When devices are discovered, the devices appear on the right side of the screen. If no devices are discovered, the message **No devices found** appears.

To perform another device discovery, click the circular arrows button in the top right corner of the screen.



## Connect to the WVA

After you have discovered devices, you can connect to a WVA in the discovered devices list.

---

**Note** The code for the WVA demo application can automatically detect when the WVA device closed its end of the event channel socket. The WVA demo application waits **15** seconds before attempting to reconnect.

---

1. In the discovered devices list, connect to the WVA by clicking the device name in the device pane. This opens the dashboard.



---

**Note** Alternatively, you can connect to the WVA manually. See [Optional: Manually connect to the WVA](#).

---

2. A login prompt appears. For **username**, enter **admin**; for **password**, enter **admin**. Under **HTTPS Security**, in most cases, select **Use HTTPS**.

---

**Note** If the login is unsuccessful, it is possible that the default **Network Services** setting on the WVA for **Enable Secure Web Server (HTTPS)** changed from the default setting (enabled) to use **Enable Web Server (HTTP)** or is disabled. The demo application and the WVA must sync in their use of HTTPS or HTTP. See [Demo application: user login fails](#).

---





3. When the login completes, if your network is set up properly, the demo application attempts to initiate a connection to the selected device. Once the connection is initiated, the [Review the demo application dashboard](#) appears.

### Optional: Manually connect to the WVA

You can manually connect to the WVA, if you prefer this method over using the discovery method.

1. On the action bar, click the action overflow button:



2. Select **Settings**. The **Applications** settings dialog appears.

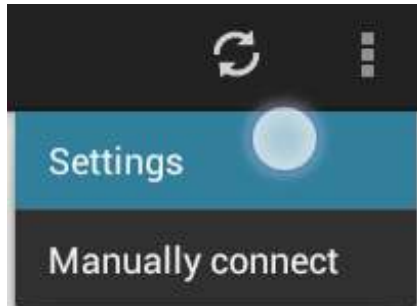

3. Under **Connection Settings**, select **IP address for manual connection**.
4. Enter the IP address of the WVA and click **Save**.
5. Once the IP address is set, anytime you want to make a manual connection, click the action overflow button and select **Manually connect**.

### Review the demo application dashboard

The first time the demo application opens, the demo application dashboard is empty. After the application discovers all available data endpoints, and optionally subscribes to them, the dashboard populates with data endpoints.

The dashboard has three panels:

- **Vehicle Data:** Displays the most recent vehicle bus data for which subscriptions have been made.
- **Event Log:** Displays a log of vehicle bus data updates and alarms sent over the Event Channel.
- **Alarms and Subscriptions:** Displays all vehicle bus data endpoints, which can be subscribed to or set for alarms.

You can also see a graph view that plots several endpoints. See [Show graph view](#).

## Show graph view

The demo application has a graph view. Click the action overflow button and select **Show graph**.



The graph is built from two vehicle bus data endpoints, **VehicleSpeed** and **EngineSpeed**. Whenever any new data for the endpoints come in to the application through the Event Channel, the graph view plots these endpoints.

**Note** To use the Graph View from the demo application, you must perform a **Sync Time** operation to synchronize the WVA system time with the Android device clock. Click the action overflow button and select **Sync time**.

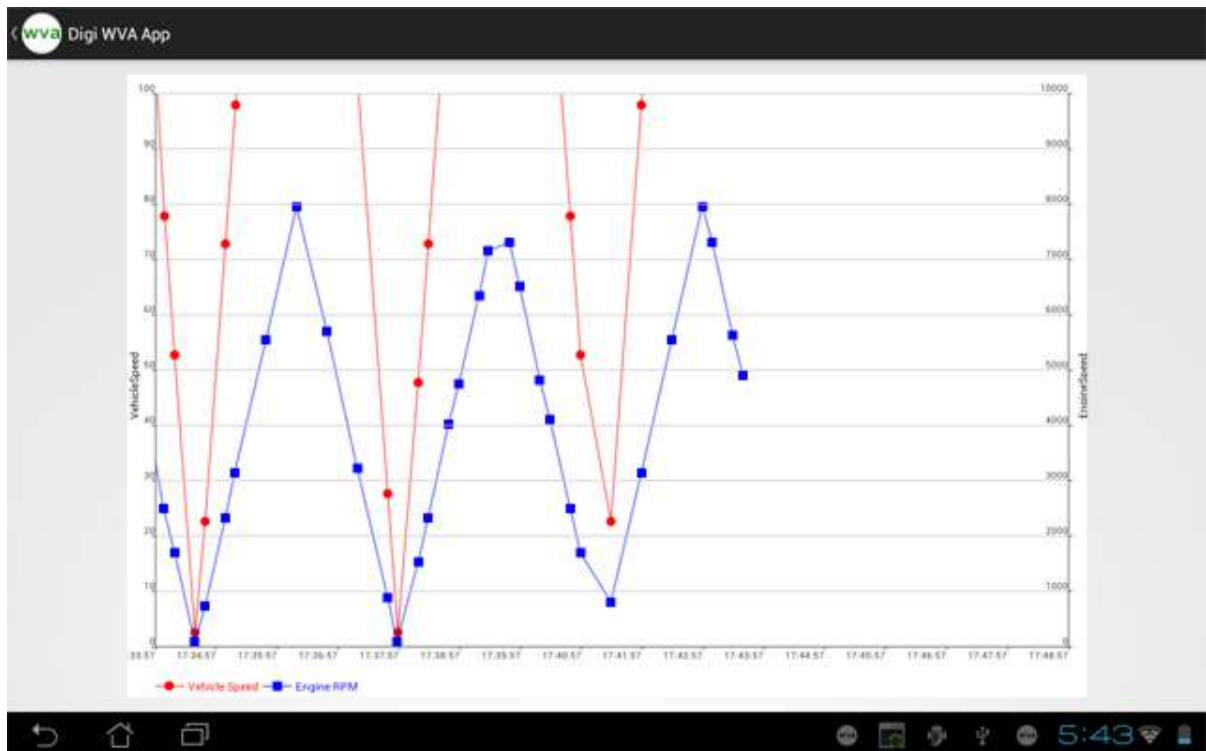

## Configure endpoints: subscriptions and alarms

The dashboard has several options for handling vehicle bus data endpoints:

- [Subscribe to an endpoint](#). You can subscribe to individual endpoints or to all vehicle data endpoints automatically in the application settings.
- [Configure an endpoint as an alarm](#).
- [Delete an alarm](#).

## Subscribe to an endpoint

The following example uses an endpoint named **BatteryPotential**.

1. In the dashboard's **Alarms and Subscriptions** panel, select the endpoint.



The **Endpoint** dialog appears:

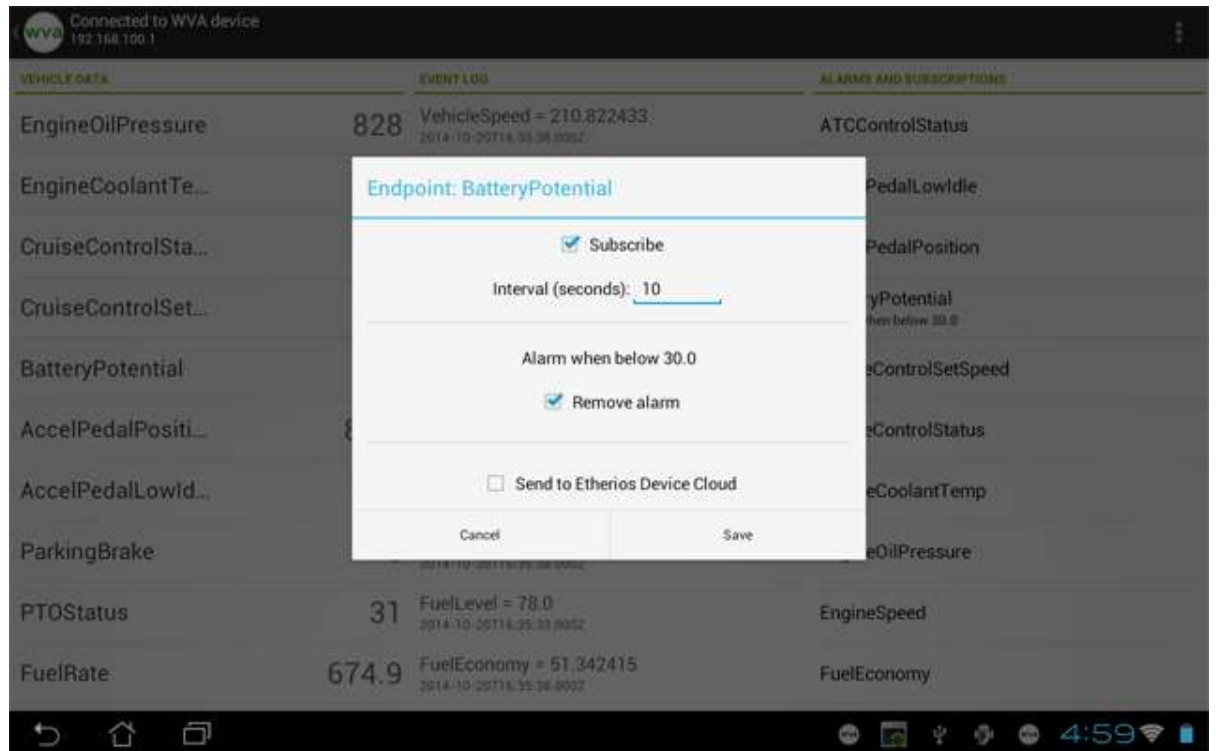

2. Subscribe to the endpoint.
  - a. Select **Subscription enabled**.
  - b. In the **Interval** value, specify the desired number of seconds between updates for the endpoint.
3. When the endpoint is configured, it appears in the **Vehicle Data** panel:

Connected to WVA device  
192.168.100.1

VEHICLE DATA	EVENT LOG	ALARMS AND SUBSCRIPTIONS
EngineOilPressure	868 VehicleSpeed = 215.841644 2014-10-20T16:32:48.000Z	ATCCControlStatus
EngineCoolantTe...	177 TripDistance = 600799.375 2014-10-20T16:32:43.000Z	AccelPedalLowIdle
CruiseControlSta...	7 TotalEngineHours = 900099.125 2014-10-20T16:32:43.000Z	AccelPedalPosition
CruiseControlSet...	255 TotalDistance = 601599.375 2014-10-20T16:32:43.000Z	BatteryPotential
BatteryPotential	51 Throttle = 102.0 2014-10-20T16:32:48.000Z	CruiseControlSetSpeed
AccelPedalPositi...	86.8 ParkingBrake = 0.0 2014-10-20T16:32:48.000Z	CruiseControlStatus
AccelPedalLowId...	3 PTOStatus = 31.0 2014-10-20T16:32:48.000Z	EngineCoolantTemp
ParkingBrake	0 FuelRate = 1272.050049 2014-10-20T16:32:48.000Z	EngineOilPressure
PTOStatus	31 FuelLevel = 92.800003 2014-10-20T16:32:43.000Z	EngineSpeed
FuelRate	1272.05 FuelEconomy = 68.788567 2014-10-20T16:32:48.000Z	FuelEconomy

## Configure an endpoint as an alarm

You can configure an endpoint to act as alarm. When the alarm threshold is met, the alarm appears in the Event Log, and an alarm notification is sent to the Android device's notification drawer.

The following example uses an endpoint named **BatteryPotential**.

1. In the dashboard's **Alarms and Subscriptions** panel, select the endpoint.
2. Select **Alarm enabled**.
3. Select an alarm threshold option.
  - **Above:** When the data exceeds a certain value. A threshold value must also be entered.
  - **Below:** When the data falls below a certain value. A threshold value must also be entered.
  - **Change:** Any change in value. Selecting **Change** disables the **Threshold** field.
  - **Delta:** When the data changes by a certain amount.

For example, this endpoint is configured for an alarm when the value of **BatteryPotential** drops below **30**:

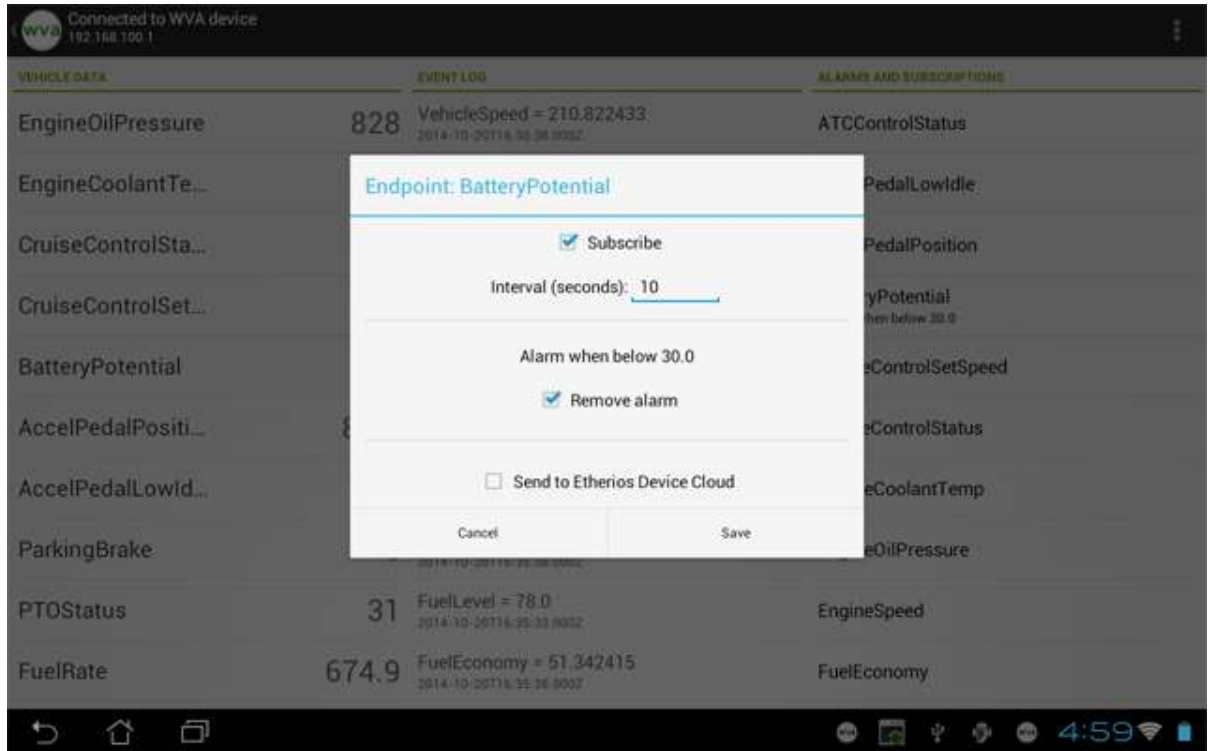

4. Click **Save**. The alarm appears in the Event Log, and an alarm notification is sent to the Android device's notification drawer.

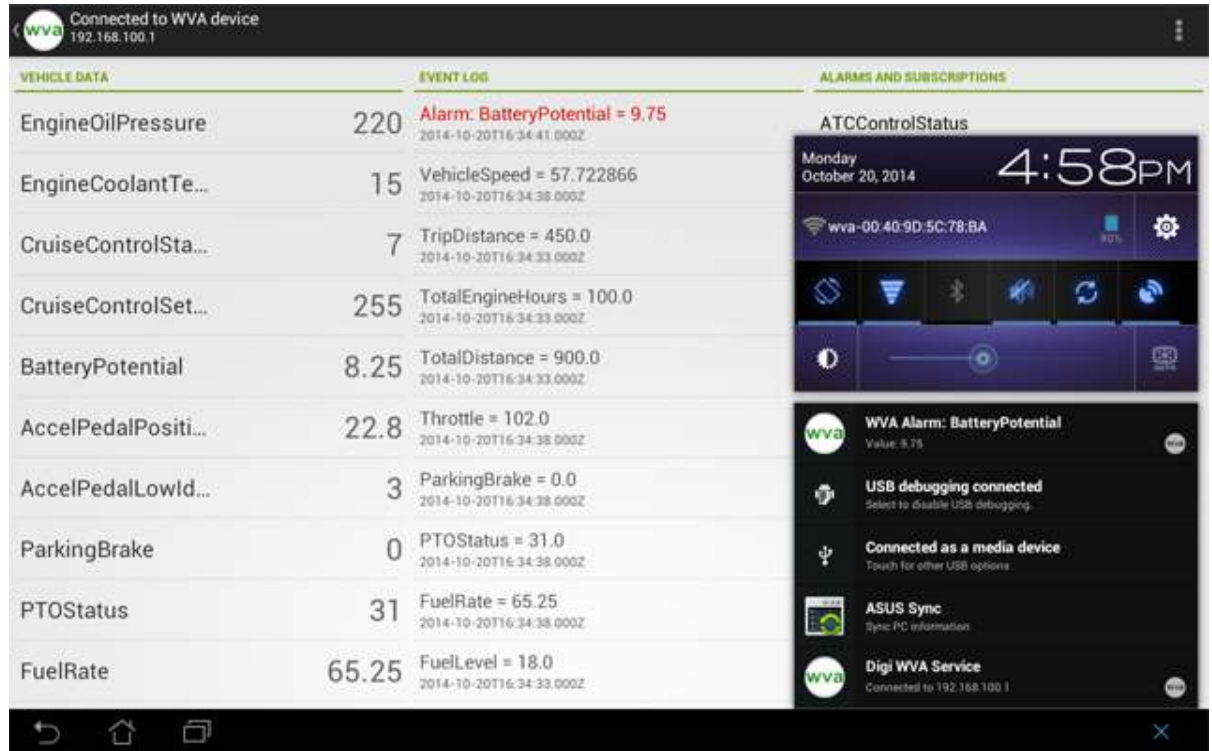

## Delete an alarm

The following example uses an endpoint named **BatteryPotential**.

1. In the dashboard's **Alarms and Subscriptions** panel, select the endpoint.
2. Select the endpoint. The endpoint dialog appears.

3. Select **Remove alarm**.

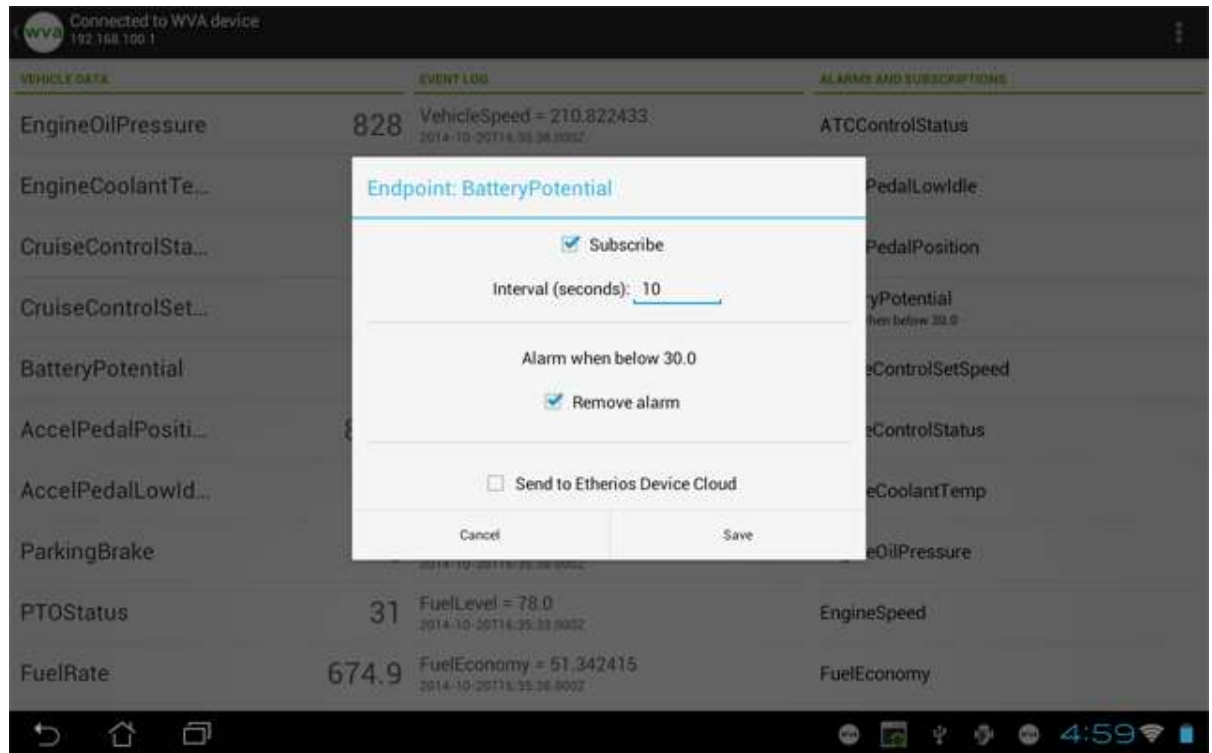

4. Click **Save**.

## Change application settings

The demo application has several settings and preferences.

To access these settings:

1. Click the action overflow button and select **Settings**. The **Application settings** page appears.
2. On the **Settings** activity, you can configure application preferences such as alarm notification sound.



The demo app settings are as follows:

- **Notifications:** Preferences on notifications.
  - **Alarm tone:** The sound played when an alarm is triggered on the device.
- **Connection Settings:** Settings for network connections.



- **IP address for manual connection:** Identifies the IP address that is the destination for a manual device connection. Once set, the manual connection can be established by selecting **Manual**.
- **TCP port for events:** The TCP network port number used for the Event Channel. The WVA demo application is set to use port number **5000**, but this number can be changed.
- **Application Settings:** Settings for subscriptions and the Event Log.
  - **Endpoint auto-subscription:** After successfully connecting to a device, there are essentially two options for subscribing to vehicle bus data endpoints: automatically subscribe to all available data endpoints, or subscribe to no data endpoints at all. This option allows you to specify which subscription option should be used. To subscribe to no vehicle bus data endpoints when the application dashboard is opened, select **Don't subscribe to anything**. To subscribe to all vehicle bus data endpoints for a specified interval, select one of the available time intervals.
  - **Auto-scroll event log:** In the Event Log, new events are displayed at the top of the log. This setting causes the log display to automatically scroll to the top of the log when new log events occur.

## Review fault codes

After you have connected to the WVA and collected data, you can review the fault codes.

**Note** You can create alarm conditions on a fault code. See [Create an alarm on vehicle data](#) in the *WVA Android Library Tutorial* for more information.

1. In the application menu, click **Fault Codes**.

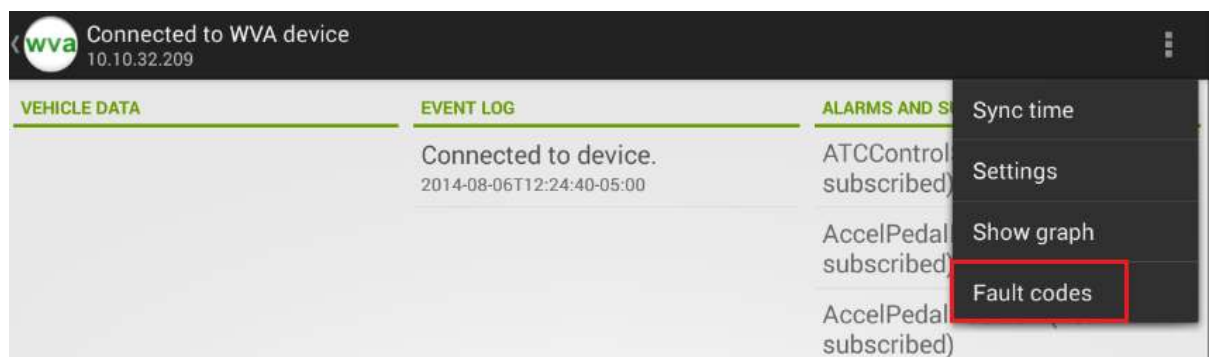

2. The **Fault Code Browser** screen displays.

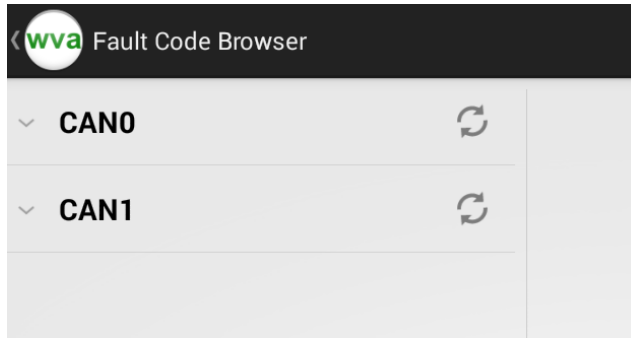

3. Click on one of the CAN bus headings to query the WVA for the list of ECU units on that CAN bus. You can click the **Refresh** icon to update the list.

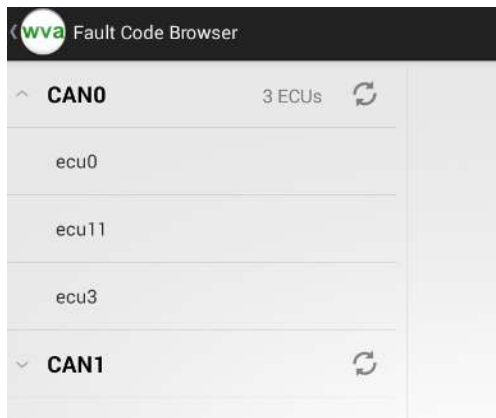

4. From the list of ECU units, click on the ECU for which you want to inspect fault codes. Fetching fault code options appear in the right-hand pane.

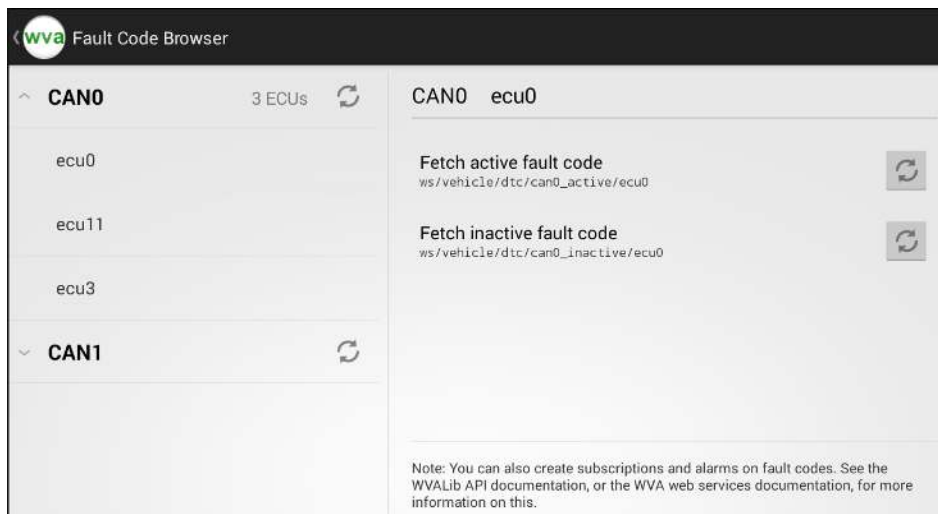

5. Click **Fetch active fault code** to query the WVA for the most recently reported active fault codes. The active fault codes appear on the screen. If there are no active fault codes, the message "No active fault codes have been reported" displays on the screen.

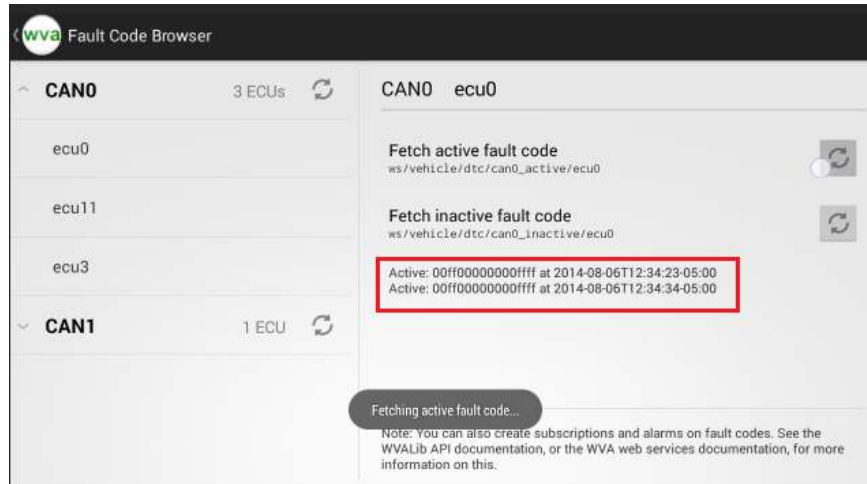

6. Click **Fetch inactive fault code** to query the WVA for the most recently reported inactive fault codes. The inactive fault codes appear on the screen. If there are no inactive fault codes, the message "No inactive fault codes have been reported" displays on the screen.

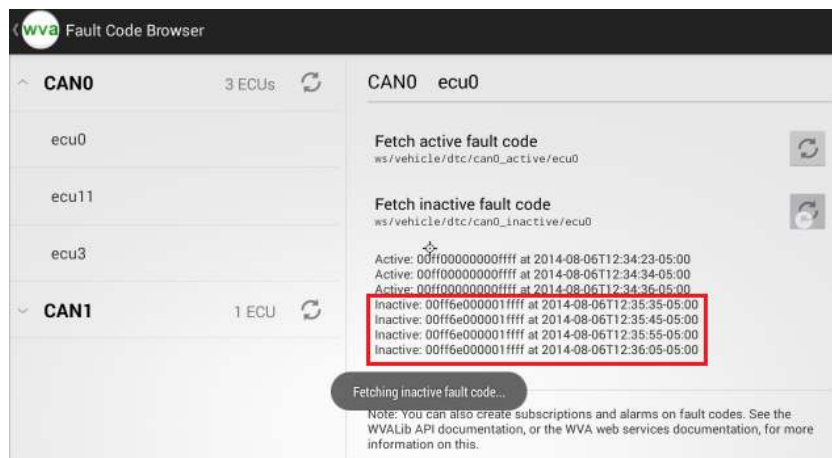

## Demo application issues

In some conditions, the demo application has error-handling built in. You can click **OK** on some to initiate error handling. However, some errors and conditions may require action on your part.

For more information about demo application error messages, see [Demo application error messages](#).

Refer to the following topics for demo application troubleshooting issues:

- [Demo application: Wi-Fi hotspot issues](#)
- [Demo application: user login fails](#)
- [Demo application: Connection Refused error \(ECONNREFUSED\)](#)
- [Demo application: Connection has gone away error](#)

## Demo application error messages

If any errors occur with the data connection, an error dialog appears. Click **OK** and the error is handled according to the design of the application.

### **Failure to connect to device**

This error occurs if you cannot connect to the WVA device.



### **Lost network connection**

This error occurs while you are connected to the discovered WVA and the network connection is lost.

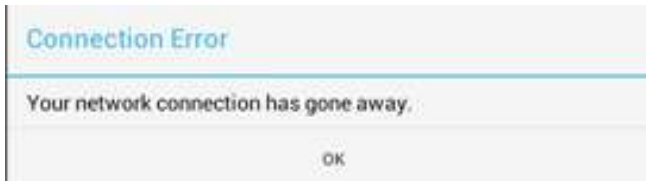

### **Android device not connected to Wi-Fi network**

If your Android device is not properly connected to a Wi-Fi network, a message displays indicating that you cannot attempt to connect to the device without first checking your connection: "Must be on Wi-Fi or serving as a hotspot to use this application".

## Demo application: Wi-Fi hotspot issues

In the demo application, during the [Connect to the WVA](#) step, this message may appear:

---

Must be on Wi-Fi or serving as hotspot to use this application.

---

### **Possible cause**

The Android device is not connected to the WVA, or is not in Access Point (mobile hotspot) mode.

### **Solution**

Make sure the Android device is connected to the WVA before trying to connect to the demo application.

## Demo application: user login fails

Your user login to the demo application fails.

### Possible cause

- The demo application and the WVA must synchronize their use of security and authentication. The WVA's Network Services settings for security and authentication may have been changed from their defaults but the demo application is assuming a use of the defaults.
- There is also a chance that the Secure Web Server (HTTPS) and Web Server (HTTP) network services have been disabled entirely.

### Solution

If possible, review how the Network Services settings for HTTPS/HTTP are set for the WVA in the web interface.

1. Attempt to open the web interface on the WVA.
2. If you can open the web interface, go to **Configuration > Network Services**. Check the settings for **Enable Secure Web Server (HTTPS)** and **Enable Web Server (HTTP)** and make these changes in the demo application:
  - If HTTPS is on (checked) and HTTP is off (unchecked) (the default), make sure to check **Use HTTPS**.
  - If HTTPS is off (unchecked), make sure to deselect **Use HTTPS**.
3. If you cannot open the web interface, both HTTP and HTTPS may have been disabled on the WVA. In this case, you cannot access a web browser to display and change settings. The only way to return the WVA to the default setting of HTTP being enabled is to reset the device to factory defaults. See [Reset the WVA to factory defaults](#).

## Demo application: Connection Refused error (ECONNREFUSED)

In the demo application, this connection error appears:

---

```
Connection with the WVA device encountered an error: failed to connect to device address (port 5000):  
Connect failed  
ECONNREFUSED (Connection Refused)
```

---

### Possible cause

- The demo application was not able to set the Event Channel port properly.
- The demo application attempted to connect to the named port before the port was set, or during the approximately **15** seconds the web service daemon requires for restart after setting the port.

### Solution

Try connecting to the WVA again. See [Connect to the WVA](#).

## Demo application: Connection has gone away error

In the demo application, you see the following connection error:

---

```
Connection has gone away
```

---

**Possible cause**

The Android device has been disconnected from the WVA. The demo application detects that condition owing to a change in the Android device's network state. For example, the Android device was connected to the WVA's Wi-Fi network, but the current state is not connected to Wi-Fi or connected to another network type.

**Solution**

Try connecting to the WVA again. See [Connect to the WVA](#).

## Troubleshooting

---

See the following topics for assistance if you run into issues with your WVA, such as connectivity problems. If you need further assistance, contact Digi Technical Support at [www.digi.com/support](http://www.digi.com/support).

Power LED is dark .....	72
Device is not discovered by Digi Device Discovery .....	73
Cannot open web interface or access web services .....	75
Cannot receive data from the CAN bus .....	76
WVA does not connect to an access point .....	77
Wi-Fi access issues .....	78
Cannot discover device using Wi-Fi Direct .....	79
Cannot associate with WVA over Wi-Fi Direct in push-button mode .....	80
Cannot associate with WVA over Wi-Fi Direct in PIN mode .....	81
Wireless signal strength issues .....	82

## Power LED is dark

The **Power** LED on the WVA is dark.

---

**Note** For more information about the WVA LEDs, please refer to [WVA LEDs](#).

---

### Possible cause

Power is not applied.

#### **Solution**

Make sure the power supply is properly connected to a power source and the device.

### Possible cause

Hardware failure.

#### **Solution**

1. Disconnect the WVA from the power source.
2. Reconnect the WVA to the power source.
3. If the **Power** LED remains dark, return the WVA to your supplier.



## Device is not discovered by Digi Device Discovery

### Possible cause

Another device user may have disabled the Device Discovery Service (ADDP) network service.

#### **Solution**

Check the **Network Services** settings. In the web interface, go to **Configuration > Network Services** and check the **Device Discovery Service (ADDP) Mode** setting.

If the setting is **Off**, change it to either **Read-Write** (enable Device Discovery Service and allow network settings to be changed) or **Read-Only** (enables Device Discovery Service only) and click **Apply**.

### Possible cause

Firewalls, either software or physical, are in place.

#### **Solution**

Make sure that any software firewalls are disabled, as software firewalls can block the discovery process. Any physical firewall will almost certainly block the discovery process.

### Possible cause

A router between the computer running the Digi Device Discovery utility and the WVA. Normally, routers will block the discovery process.

#### **Solution**

If possible, remove any routers between the computer and the WVA and use a hub instead.

### Possible cause

A switch between the computer and the WVA the Digi Device Discovery utility is configured to block the discovery traffic.

#### **Solution**

Occasionally switches are configured to block the discovery traffic. If unsure, use a hub or a direct Ethernet cable connection.

### Possible cause

Bad port on your router/switch/hub.

#### **Solution**

Try using a different port.

## **Possible cause**

Unknown.

### ***Solution***

If you have a second Digi device, try discovering it instead to see if you have the same problem. Though it may not solve your original discovery problem, it should provide you with some additional troubleshooting clues.

## Cannot open web interface or access web services

### Problem

Cannot open the WVA web interface or access any of the web services.

### Possible cause

Password has been changed from the default: **admin**.

#### **Solution**

Check whether another user of the device changed the password. To change the password back to the default, [Reset the WVA to factory defaults](#).

### Possible cause

The Web Server network service (HTTP or HTTPS) is disabled.

#### **Solution**

[Reset the WVA to factory defaults](#). See [Configure network services](#) for more information on HTTP and HTTPS services.

## Cannot receive data from the CAN bus

When the WVA is connected wither to a CAN simulator or a vehicle diagnostic port, it does not receive data from the CAN bus.

### Possible cause

When connecting to a CAN simulator, the baud rate was set to **Auto Baud** or an incorrect baud rate.

#### **Solution**

In the web interface, go to **Configuration > CAN Bus**. Make sure the **Baud Rate** setting is set to **250000**. For more information, see [Configure CAN bus baud rate \(CAN bus simulator use only\)](#).

### Possible cause

When connecting to a vehicle diagnostic port, the WVA is using the incorrect baud rate.

#### **Solution**

For vehicle use, the baud rate should always be **Auto Baud**. In the web interface, go to **Configuration > CAN Bus**. Make sure the **Baud Rate** setting is set to **Auto Baud**. For more information, see [CAN Bus page descriptions](#).

## WVA does not connect to an access point

The WVA does not connect to an access point.

### Possible cause

- Device is already configured as an access point only.
- The SSID changed.

### Solution

1. Determine and verify the new access point to which the WVA should connect.
2. Use the Digi Device Discovery Utility to rediscover the WVA. See [Rediscover the WVA](#).
3. If the problem persists, reset device to factory defaults. See [Reset the WVA to factory defaults](#).

## Wi-Fi access issues

Cannot access the WVA via Wi-Fi.

### Possible cause

You entered an incorrect WPA passkey.

#### ***Solution***

Determine the correct WPA passkey and enter it. You can also reset the WPA passkey to the default by resetting the device to factory defaults. See [Reset the WVA to factory defaults](#).

## Cannot discover device using Wi-Fi Direct

Cannot discover the WVA using the Wi-Fi Direct method.

### Possible cause

- The WVA may not be configured for Wi-Fi Direct.
- The Wi-Fi Direct device name may have changed.

### Solution

1. [Reset the WVA to factory defaults](#) to force it to a known, accessible state.
2. Connect to the device via its access point.
3. Run the Wi-Fi Direct wizard to enable Wi-Fi Direct mode, assign a known Wi-Fi Direct device name, and select the appropriate association method. See [Configure wireless settings](#).
4. If authentication via PIN has been selected, record the correct PIN.

## Cannot associate with WVA over Wi-Fi Direct in push-button mode

Cannot associate with the WVA over Wi-Fi Direct when in push-button mode.

### Possible cause

- The WVA might not be configured for Wi-Fi Direct.
- Authentication via push-button is not enabled.

### Solution

1. [Reset the WVA to factory defaults](#) to force it to a known, accessible state.
2. Connect to the device via its access point.
3. Run the Wi-Fi Direct wizard to enable Wi-Fi Direct mode, assign a known Wi-Fi Direct device name, and select the appropriate association method. See [Configure wireless settings](#).
4. If authentication via PIN is selected, record the correct PIN.



## Cannot associate with WVA over Wi-Fi Direct in PIN mode

Cannot associate with the WVA over Wi-Fi Direct when in PIN mode.

### Possible cause

- The WVA is not configured for Wi-Fi Direct.
- Authentication via PIN is not enabled.
- Forgotten or changed PIN.

### Solution

1. [Reset the WVA to factory defaults](#) to force it to a known, accessible state.
2. Connect to the device via its access point.
3. Run the Wi-Fi Direct wizard to enable Wi-Fi Direct mode, assign a known Wi-Fi Direct device name, and select the appropriate association method. See [Configure wireless settings](#).
4. If authentication via PIN is selected, record the correct PIN.

## Wireless signal strength issues

Poor to no wireless signal strength.

### Possible cause

Wireless signal strength issues can stem from a number of factors.

- **Environmental factors:** Various factors can slow down the data rate, lose data, or even ruin the connection. For example:
  - Materials can interfere with communications. Metal, silvering (mirrors), thick glass, concrete, ceramic, walls, and even large groups of people can absorb or reflect wireless signals.
  - Metal enclosures can block the Wi-Fi signal.
  - Other types of signals can interfere with communications: microwaves, fluorescent lights, motors, 2.4 GHz phones, other Wi-Fi devices, and some military equipment, such as radar devices.
- **Range:** As the distance between two devices increases, the received signal between them is reduced. This distance also affects the speed of the connection (throughput). If the devices have a strong signal between them, their transmit speeds will be highest. As distance increases and signals get weaker, the devices will lower their speed. This decrease will have the effect of extending their range. At some point, when the range is too great, the connection does not work well or is lost entirely.
- **Security features:** Security on a Wi-Fi device introduces several factors that can go wrong. For example, it is easy to introduce errors when enabling security features, such as the WPA Pre-Shared Key. These errors can cause the Wi-Fi module to not associate with anything and stop responding. In such a scenario, the only resolution is to reset the device to factory defaults and repeat the device configuration process.

### Solution

When installing the WVA in a vehicle, it is not recommended to mount the WVA under the dash. If you must mount the WVA under the dash, make sure there are no metal enclosures near it.

If a security feature causes you to be locked out of the WVA, reset the device to factory defaults and repeat the device configuration process. For more information, see [Reset the WVA to factory defaults](#).

## Regulatory information

---

### WVA J250 model

The J250 model is certified for the US regulatory domain only.

### WVA J200 model

#### Anatel

MODELO: WVA-J200



Para maiores informações, consulte o site da ANATEL [www.anatel.gov.br](http://www.anatel.gov.br).

Este equipamento não tem direito à proteção contra interferência prejudicial e não pode causar interferência em sistemas devidamente autorizados.

Este produto não é apropriado para uso em ambientes domésticos, pois poderá causar interferências eletromagnéticas que obrigam o usuário a tomar medidas necessárias para minimizar estas interferências.