

**NOTES:**

1. Material : Music Wire
2. Finish : Glod Irridite
3. Ends : Closed and Ground
4. Total Coils : 10.000
5. Sugg. Max. Deflection : 0.180 (in)
6. Sugg. Max. Load : 2.300 (lbs)
7. All Drawing Dimensions are in Inches [mm]

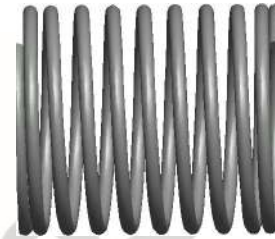

∅ 0.030  
[0,76]  
WIRE DIA



GROUND  
SURFACE

1.910  
[48,51]  
LENGTH

∅ 0.500  
[12,70]  
O.D

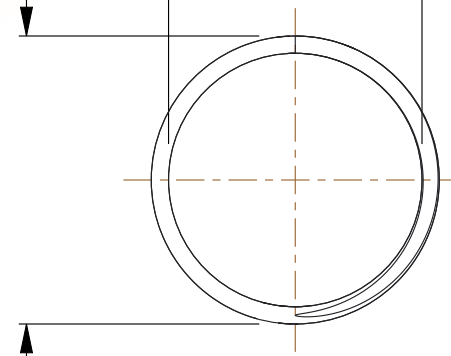

∅ 0.440  
[11,18]  
I.D

| COMPONENT                               |  | SPRINGS |           |
|---|--|---------|-----------|
| <b>11772</b><br><br>COMPRESSION SPRINGS |  | UNIT    | INCH [mm] |
|   |  | SHEET   | 1 of 1    |
|   |  |         |           |