

#### 4 Hanging the TV onto the Wall Plate

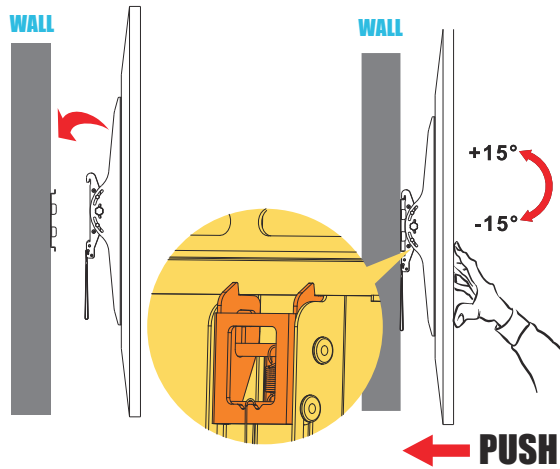

Using an assistant, hang the TV onto the wall plate carefully by pushing the bottom of the TV towards the wall until the latches fit into the wall plate rail. Then hide the two safety straps at the back of the TV to avoid pulling on it accidentally, which may cause the TV to release and fall.



**! IMPORTANT:**  
Make sure the TV is safely secured on the wall before releasing it. Do not pull on the safety straps unless you need to remove the TV. See step 4 on how to safely remove the TV.

#### 5 Removing the TV from the Wall Plate

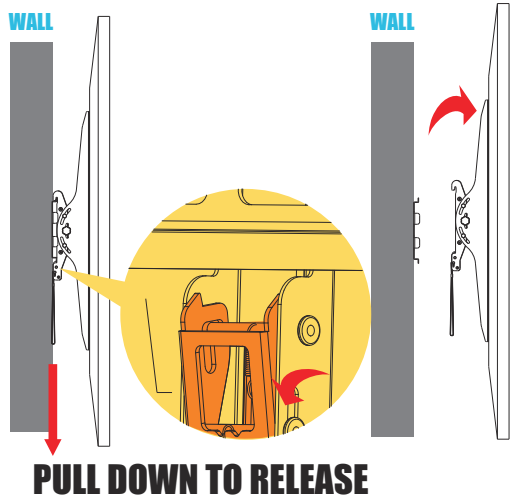

**! HEAVY!**  
Use an assistant for this step.



To remove the TV from the Wall Plate, have an assistant hold the TV while the other person pull the two safety straps downward at the same time to unlock the latches from the wall plate rail. Then carefully lift and remove the TV.

#### Maintenance

Please check that the wall mount is secure and safe to use at regular intervals. If you have any questions regarding any of the instructions or warnings, please contact your local distributor (OR) contact QualGear technical support via email at support@qualgear.com.

**QualGear**<sup>®</sup>

INSTALLATION MANUAL

**QG-TM-091-BLK**

## HEAVY DUTY TILTING TV WALL MOUNT



**100" MAX** For Most 60" to 100" Flat Panel and Curved TVs

**100kg (220lbs) RATED** **CAUTION!** Do not exceed the maximum rated weight specified. Otherwise, serious injury or property damage may occur. 

**VESA**  
200x200 | 300x300 | 400x200 | 400x400 | 600x400  
600x600 | 800x400 | 800x600 | 800x800 | 1000x400  
1000x600 | 1000x800



www.qualgear.com

■ 1 Year Limited Warranty

■ Version March 2016

**NOTE** Please read the entire installation manual before you start installation and assembly.

## WARNING

- Do not begin to install your QualGear product until you have read and understood all the instructions and warnings contained in this installation manual. If you have any questions regarding the instructions, for US customers please contact QualGear customer support via email at support@qualgear.com. For all international customers, please contact your local distributor.
- This product should only be installed by someone of good mechanical aptitude, has experience with basic building construction, and fully understands these instructions.
- This product was designed to be installed and utilized only as specified in this manual. Improper installation of this product may cause damage or serious injury. QualGear is not liable for the improper use or installation of its products.
- Make sure that the supporting surface will safely support the combined load of the equipment and all attached hardware and components.
- Always use an assistant or mechanical lifting equipment to safely lift and position the equipment.
- This product was designed to be installed on the following wall construction only:

### WALL CONSTRUCTION

Wooden Stud  
Wooden Beam  
Solid Concrete  
Other

### HARDWARE REQUIRED

Included  
Included  
Included  
Contact Qualified Professional

- Tighten screws firmly, but do not over tighten. Over tightening can damage the items, greatly reducing their holding power.
- ALL QUALGEAR products are intended for indoor use only and any outdoor use voids the limited warranty.
- ALL QUALGEAR products are designed and tested for residential use only and any commercial use voids the limited warranty. For warranty information, please visit <http://www.qualgear.com/warranty.php>.
- If mounting to wooden studs, make sure that mounting screws are anchored into the center of the studs. Use of an edge-to-edge stud finder is highly recommended.
- Never exceed the maximum rated weight specified in this manual.
- All bolts and screws must be used at the designated points in the installation instructions to prevent property damage and/or personal injury.
- DO NOT install near air conditioner vents or where there is excessive dust or smoke.
- When drilling holes in the wall, it is very important to take care of electrical cables, water, or gas pipes in the wall.

## Parts Checklist

**IMPORTANT:** Before starting installation, please check that all parts shown in this checklist are included. If any parts are missing or damaged, contact your local distributor or support@qualgear.com for replacement parts and do not start assembly and installation until you receive all the parts.

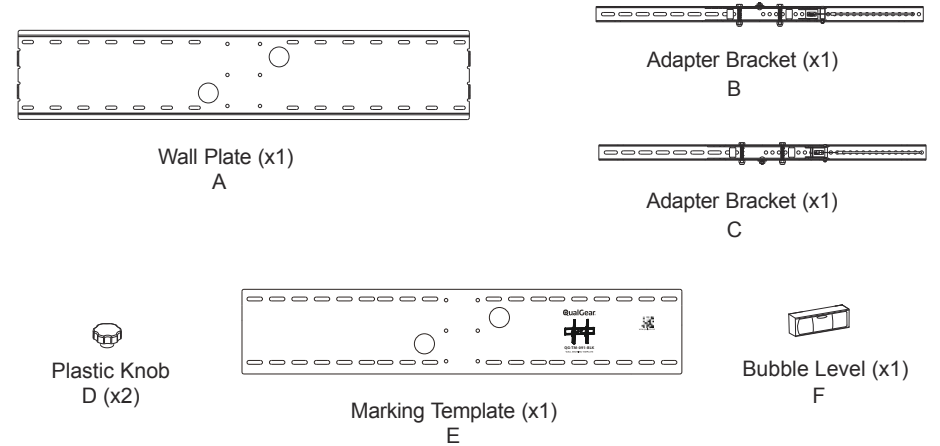

## Hardware Package

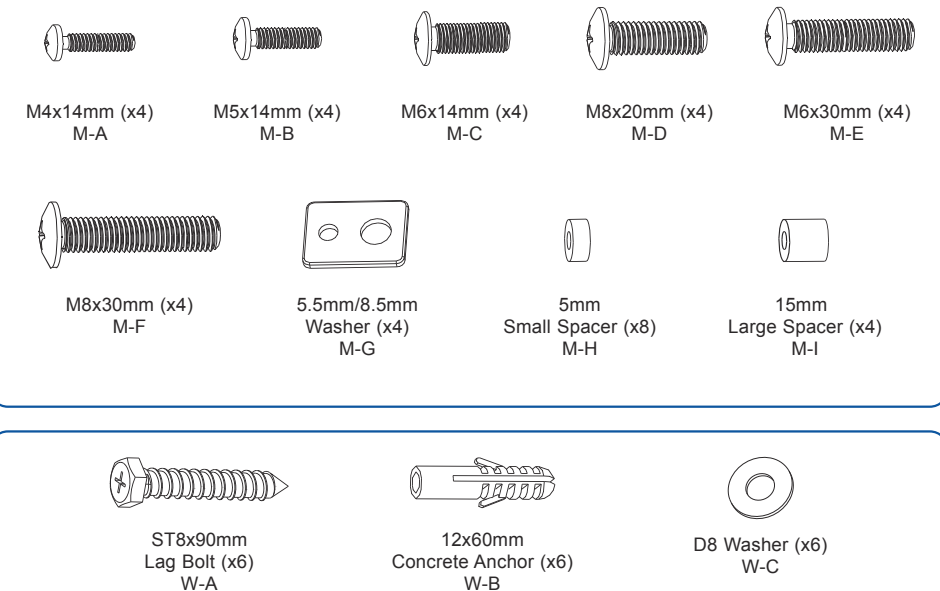

## 1 Installing the Plastic Knob

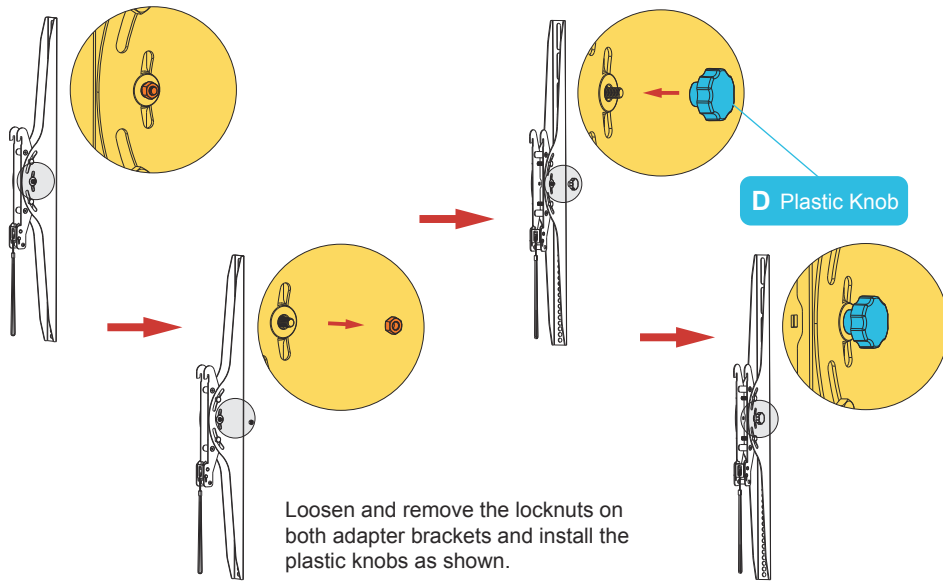

## 2a Mounting to a Wooden Stud Wall



**NOTE** For concrete wall mounting, follow Step 2b.

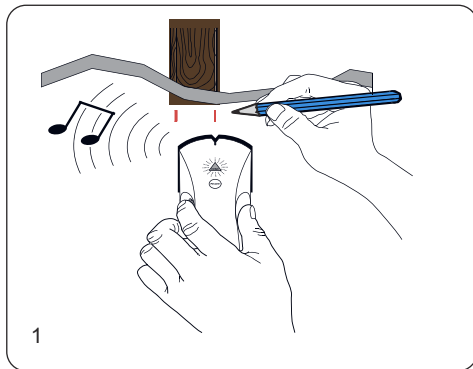

Using an edge-to-edge stud finder, find the edges of the stud.

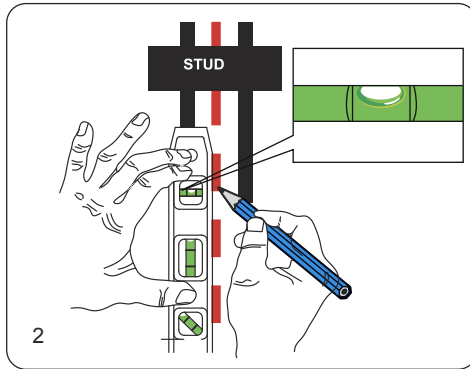

Using a level, mark the centerline of the stud.

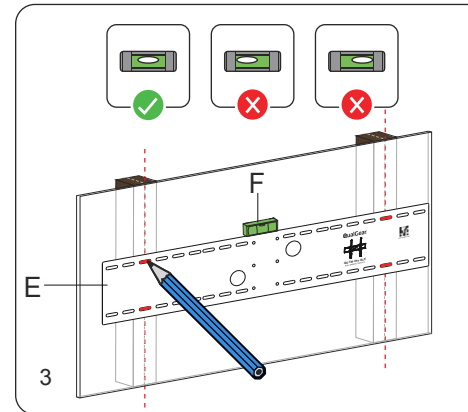

Using the marking template (E) provided, mark four holes for drilling on the centerline of the stud.

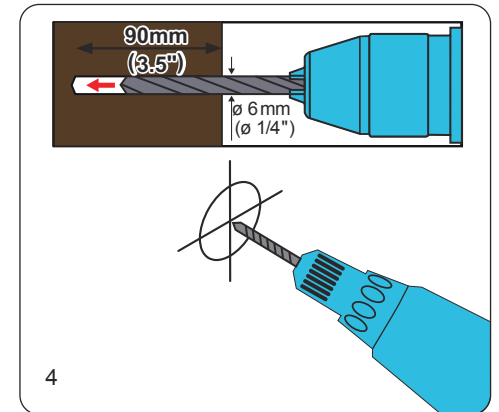

Using a power drill and 1/4" drill bit, drill pilot holes of 1/4" (6 mm) diameter and at least 3.5" (90 mm) depth.

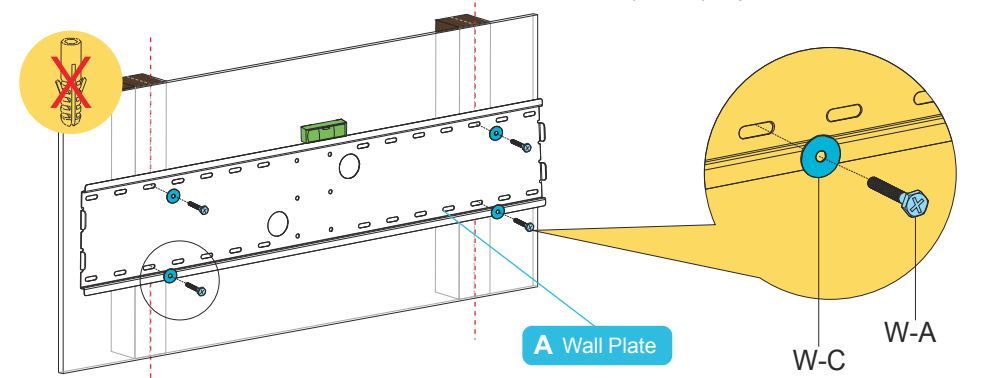

5 Mount the wall plate (A) and tighten it with the provided lag bolts (W-A) and D8 washers (W-C) using a socket wrench.

**NOTE** Do NOT use power drill and do NOT over tighten the lag bolts.

## WARNING

- Make sure that mounting screws are anchored into the center of the studs. The use of a stud finder is highly recommended.
- Installers are responsible to provide hardware for other types of mounting situations.
- Installers must verify that the supporting surface will safely support the combined weight of the equipment and all attached hardware and components.

SKIP TO STEP 3 →

## 2b Mounting to a Concrete Wall



E Marking Template

F Bubble Level

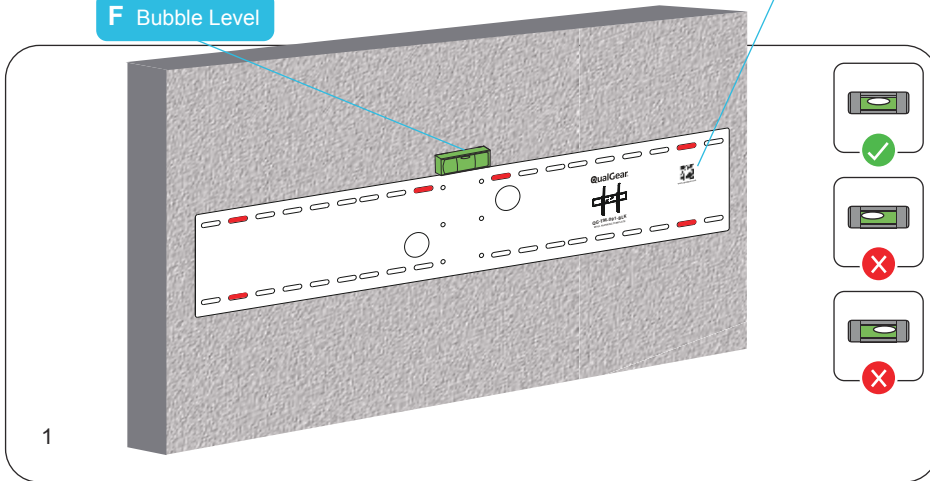

1 Hold the marking template (E) provided against the wall where you want to install your TV, mark six holes for drilling.

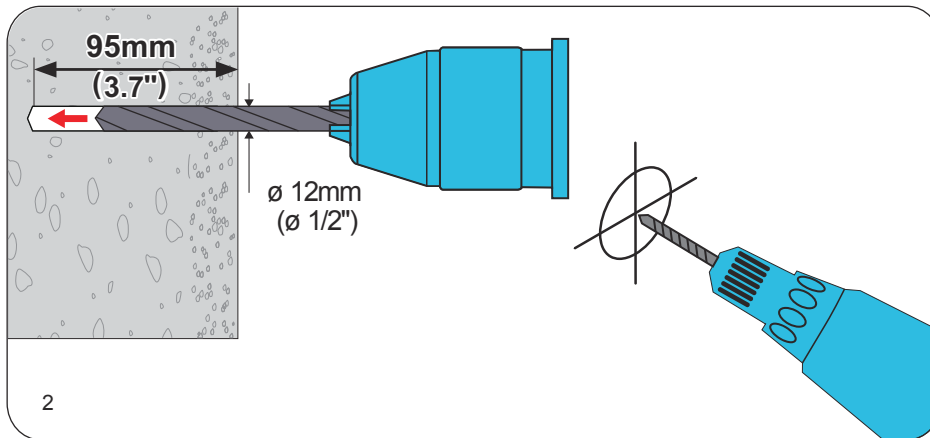

2 Using a power drill and a 1/2" masonry drill bit, drill mounting holes of 1/2" (12 mm) diameter and 3.7" (95 mm) depth at the marked locations in the previous step.

**NOTE** Do NOT use power drill and do NOT over tighten the lag bolts.

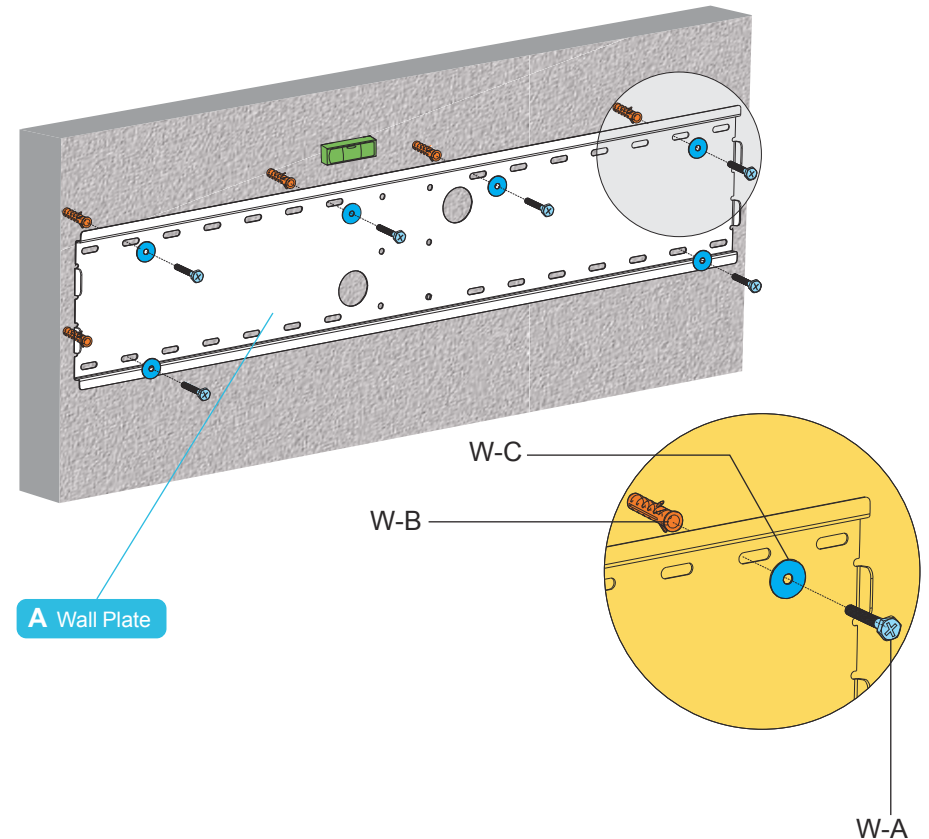

3 Place concrete anchors (W-B) in each hole. Tap each anchor flush with the wall using a hammer. Using a socket wrench, mount the wall plate (A) and fasten them with the provided lag bolts (W-A) and D8 washers (W-C).

### **! WARNING**

- Installers must verify that the supporting surface will safely support the combined weight of the equipment and all attached hardware and components.

### 3a Installing to a Flat Back Panel of a TV

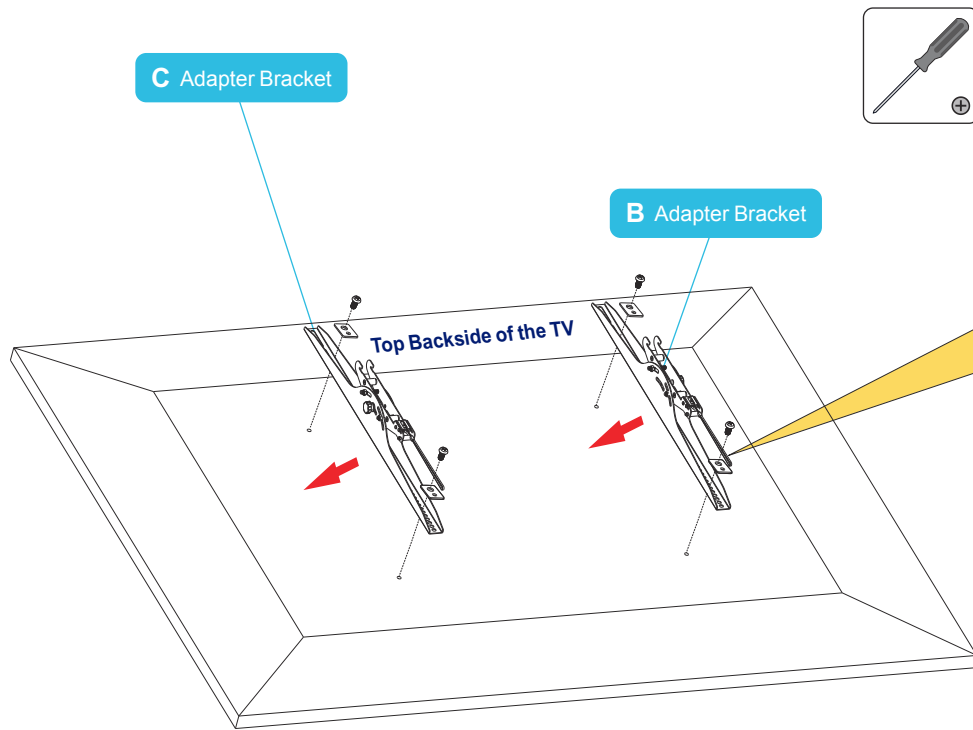

Choose the appropriate screws and washers according to the type of your TV, and attach adapter brackets (B and C) to the back of the TV using a Phillips screwdriver.

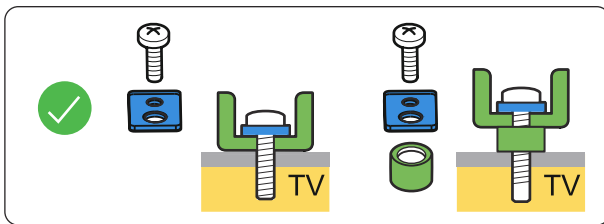

**IMPORTANT!**  
Tighten all screws but do NOT over tighten

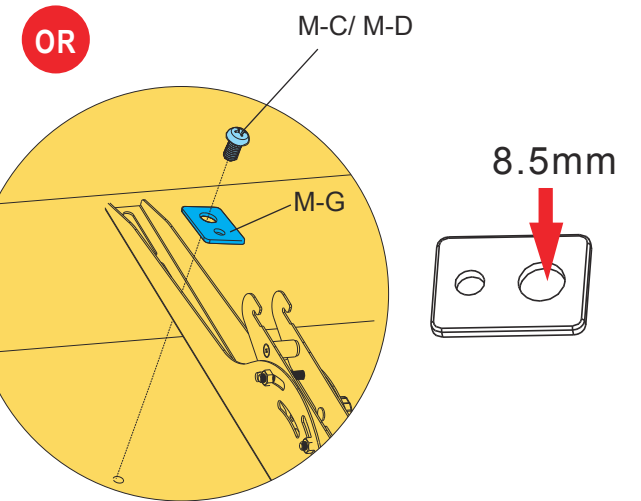
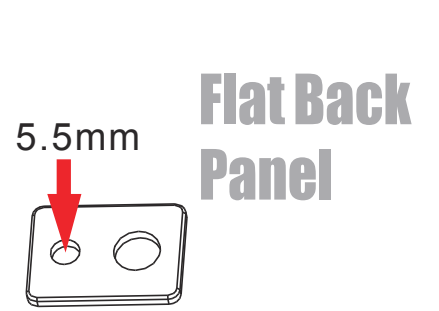
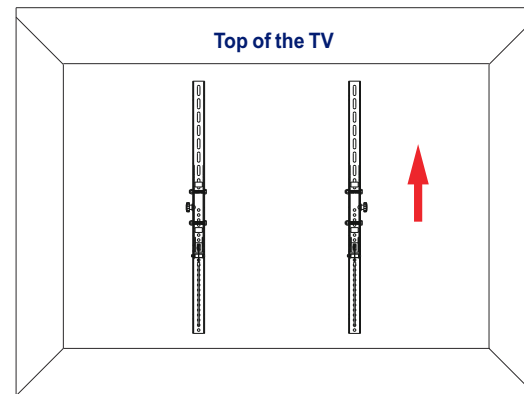
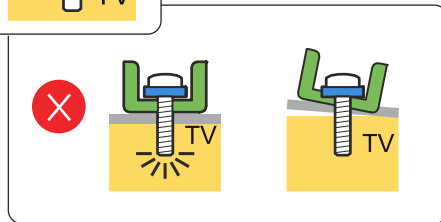

**NOTE** Make sure the adapter brackets are installed in the correct direction.

**3b Installing to a Curved or Recessed Back Panel of a TV**

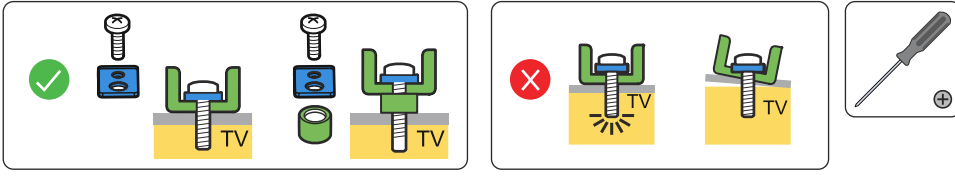

**IMPORTANT!**  
Tighten all screws but do NOT over tighten

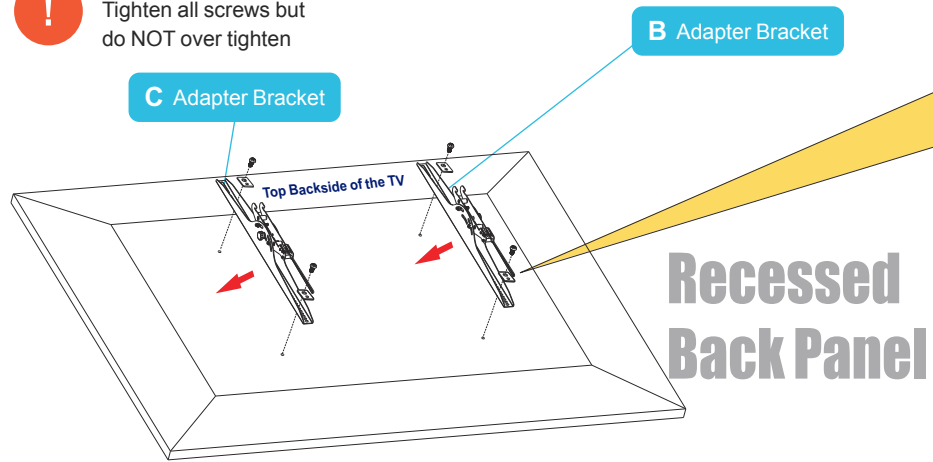

**Recessed Back Panel**

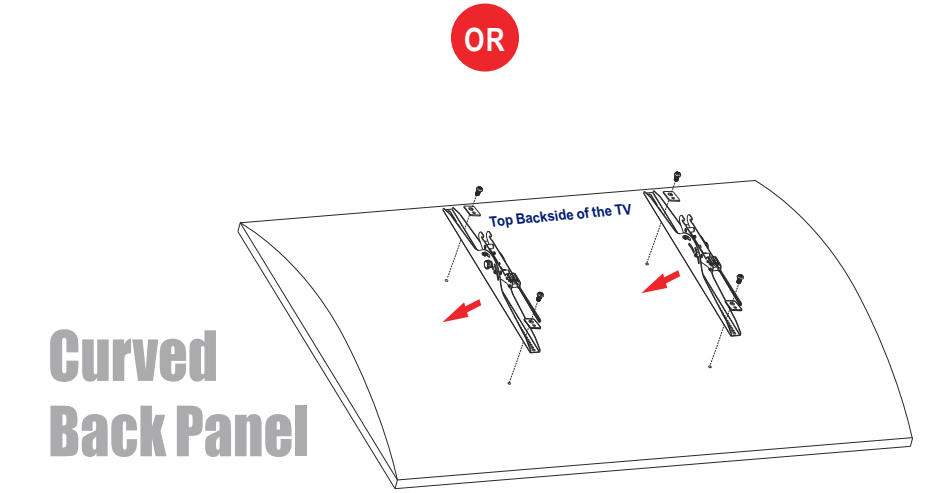

**Curved Back Panel**

Choose the appropriate screws, washers, and spacers (if necessary) according to the type of your TV and attach adapter brackets (B and C) to the back of the TV using a Phillips screwdriver.

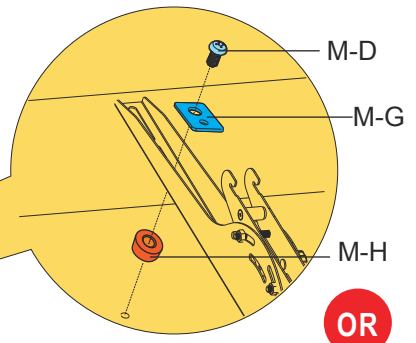

OR

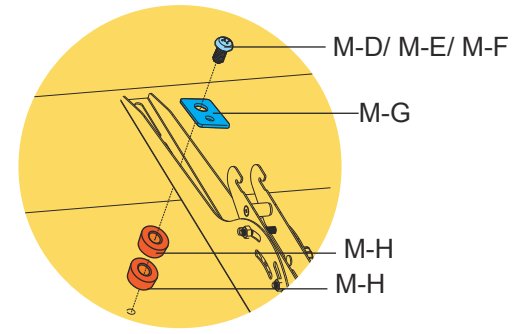

OR

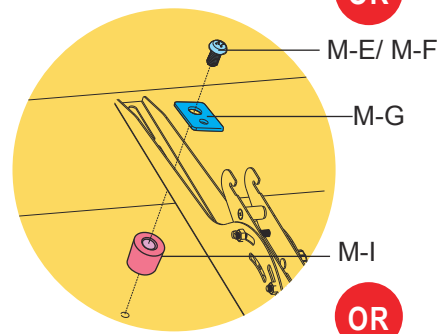

OR

