

LM48820 Boomer® Audio Power Amplifier Series **Ground-Referenced, Ultra Low Noise, Fixed Gain, 95mW Stereo Headphone Amplifier**

Check for Samples: [LM48820](#)

FEATURES

- Available in Space Saving 0.4mm Pitch DSBGA Package
- Fixed Logic Levels
- Ground Referenced Outputs
- High PSRR
- Ultra Low Current Shutdown Mode
- Improved Pop and Click Circuitry Eliminates Noises During Turn-On and Turn-Off Transitions
- No Output Coupling Capacitors, Snubber Networks, Bootstrap Capacitors, or Gain-Setting Resistors Required
- Shutdown Either Channel Independently
- Soft Start Feature Reduces Start up Transient Current

APPLICATIONS

- Mobile Phones
- MP3 Players
- PDAs
- Portable electronic devices
- Notebook PCs

KEY SPECIFICATIONS

- Improved PSRR at 217Hz: 80dB (typ)
- Power Output at VDD = 3V, RL = 16Ω, THD+N = 1%: 95mW (typ)
- Shutdown Current: 0.05μA (typ)
- Internal Fixed Gain: 1.5V/V (typ)
- Wide Operating Voltage Range: 1.6V to 4.5V

DESCRIPTION

The LM48820 is a ground referenced, fixed-gain audio power amplifier capable of delivering 95mW of continuous average power into a 16Ω single-ended load, with less than 1% THD+N from a 3V power supply.

The LM48820 features a new circuit technology that utilizes a charge pump to generate a negative reference voltage. This allows the outputs to be biased about ground, thereby eliminating output-coupling capacitors typically used with normal single-ended loads.

Boomer audio power amplifiers were designed specifically to provide high quality output power with a minimal number of external components. The LM48820 does not require output coupling capacitors or bootstrap capacitors, and therefore is ideally suited for mobile phone and other portable applications.

The LM48820 features a low-power consumption shutdown mode selectable for each channel and a soft start function that reduces start-up current transients. Additionally, the LM48820 features an internal thermal shutdown protection mechanism.

The LM48820 contains advanced pop and click circuitry that eliminates noises which would otherwise occur during turn-on and turn-off transitions.

The LM48820 has an internal fixed gain of 1.5V/V.



Please be aware that an important notice concerning availability, standard warranty, and use in critical applications of Texas Instruments semiconductor products and disclaimers thereto appears at the end of this data sheet.

All trademarks are the property of their respective owners.

Typical Application

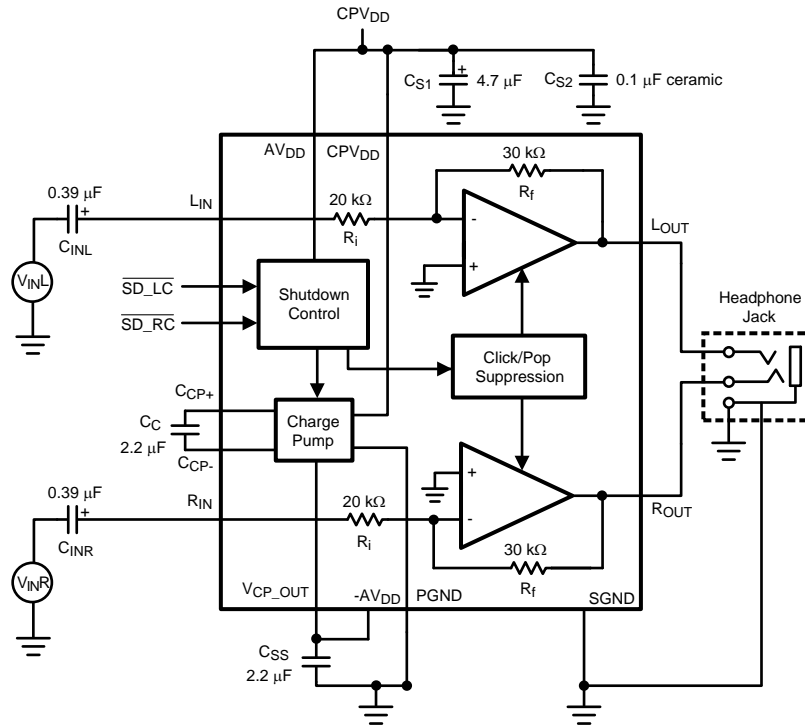

Figure 1. Typical Audio Amplifier Application Circuit

Connection Diagrams

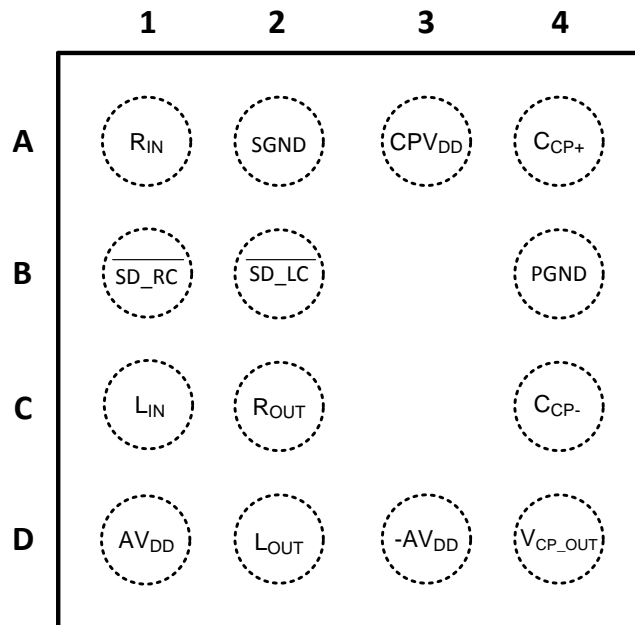

Figure 2. DSBGA Package Top View Package Number YFR0014AAA

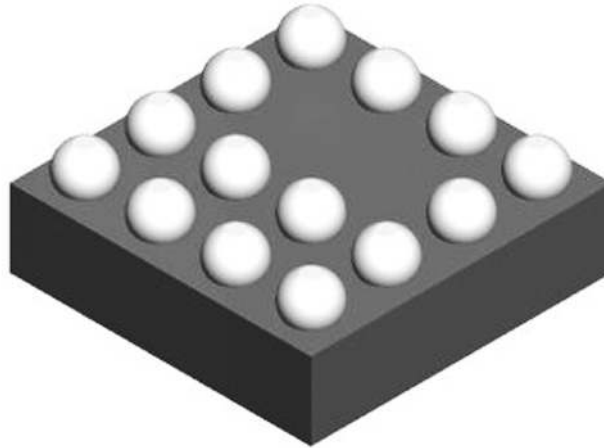

Figure 3. YFR0014 Package View

PIN DESCRIPTIONS

Pin	Name	Function
A1	R _{IN}	Right Channel Input
A2	SGND	Signal Ground
A3	CPV _{DD}	Charge Pump Power Supply
A4	C _{CP+}	Positive Terminal - Charge Pump Flying Capacitor
B1	$\overline{\text{SD_RC}}$	Active-Low Shutdown, Right Channel
B2	$\overline{\text{SD_LC}}$	Active-Low Shutdown, Left Channel
B4	PGND	Power Ground
C1	L _{IN}	Left Channel Input
C2	R _{OUT}	Right Channel Output
C4	C _{CP-}	Negative Terminal - Charge Pump Flying Capacitor
D1	AV _{DD}	Positive Power Supply - Amplifier
D2	L _{OUT}	Left Channel Output
D3	-AV _{DD}	Negative Power Supply - Amplifier
D4	V _{CP_OUT}	Charge Pump Power Output



These devices have limited built-in ESD protection. The leads should be shorted together or the device placed in conductive foam during storage or handling to prevent electrostatic damage to the MOS gates.

Absolute Maximum Ratings ⁽¹⁾⁽²⁾⁽³⁾

Supply Voltage	4.75V
Storage Temperature	-65°C to +150°C
Input Voltage	-0.3V to $V_{DD} + 0.3V$
Power Dissipation ⁽⁴⁾	Internally Limited
ESD Susceptibility ⁽⁵⁾	2000V
ESD Susceptibility ⁽⁶⁾	200V
Junction Temperature	150°C
Thermal Resistance	
θ_{JA} ⁽⁷⁾	86°C/W (typ)

- (1) All voltages are measured with respect to the GND pin unless otherwise specified.
- (2) Absolute Maximum Ratings indicate limits beyond which damage to the device may occur. Operating Ratings indicate conditions for which the device is functional but do not ensure specific performance limits. Electrical Characteristics state DC and AC electrical specifications under particular test conditions that specify performance limits. This assumes that the device is within the Operating Ratings. Specifications are not ensured for parameters where no limit is given; however, the typical value is a good indication of device performance.
- (3) If Military/Aerospace specified devices are required, please contact the Texas Instruments Sales Office/ Distributors for availability and specifications.
- (4) The maximum power dissipation must be derated at elevated temperatures and is dictated by T_{JMAX} , θ_{JA} , and the ambient temperature, T_A . The maximum allowable power dissipation is $P_{DMAX} = (T_{JMAX} - T_A) / \theta_{JA}$ or the number given in Absolute Maximum Ratings, whichever is lower. See [Typical Performance Characteristics](#) for more information.
- (5) Human body model, 100pF discharged through a 1.5kΩ resistor.
- (6) Machine Model, 220pF - 240pF discharged through all pins.
- (7) θ_{JA} value is measured with the device mounted on a PCB with a 3" x 1.5", 1oz copper heatsink.

Operating Ratings

Temperature Range	
$T_{MIN} \leq T_A \leq T_{MAX}$	-40°C $\leq T_A \leq$ 85°C
Supply Voltage (V_{DD})	1.6V $\leq V_{DD} \leq$ 4.5V

Electrical Characteristics $V_{DD} = 3V$ ⁽¹⁾⁽²⁾

The following specifications apply for $V_{DD} = 3V$, 16Ω load, and the conditions shown in "Typical Audio Amplifier Application Circuit" (see [Figure 1](#)) unless otherwise specified. Limits apply to $T_A = 25^\circ C$.

Symbol	Parameter	Conditions	LM48820		Units (Limits)
			Typical ⁽³⁾	Limit ^{(4) (5)}	
I_{DD}	Quiescent Power Supply Current Full Power Mode	$V_{IN} = 0V$, inputs terminated both channels enabled	4.7	5.5	mA (max)
		$V_{IN} = 0V$, inputs terminated one channel enabled	3		mA (max)
I_{SD}	Shutdown Current	$\overline{SD_LC} = \overline{SD_RC} = GND$	0.05	2	μA (max)
V_{OS}	Output Offset Voltage	$R_L = 32\Omega$, $V_{IN} = 0V$	1	5	mV (max)
A_V	Voltage Gain		-1.5		V/V
ΔA_V	Gain Match		1		%

- (1) All voltages are measured with respect to the GND pin unless otherwise specified.
- (2) Absolute Maximum Ratings indicate limits beyond which damage to the device may occur. Operating Ratings indicate conditions for which the device is functional but do not ensure specific performance limits. Electrical Characteristics state DC and AC electrical specifications under particular test conditions that specify performance limits. This assumes that the device is within the Operating Ratings. Specifications are not ensured for parameters where no limit is given; however, the typical value is a good indication of device performance.
- (3) Typicals are measured at 25°C and represent the parametric norm.
- (4) Limits are specified to AOQL (Average Outgoing Quality Level).
- (5) Data sheet min and max specification limits are specified by design, test, or statistical analysis.

Electrical Characteristics $V_{DD} = 3V$ ⁽¹⁾⁽²⁾ (continued)

The following specifications apply for $V_{DD} = 3V$, 16 Ω load, and the conditions shown in “*Typical Audio Amplifier Application Circuit*” (see [Figure 1](#)) unless otherwise specified. Limits apply to $T_A = 25^\circ C$.

Symbol	Parameter	Conditions	LM48820		Units (Limits)
			Typical ⁽³⁾	Limit ^{(4) (5)}	
R_{IN}	Input Resistance		20	15 25	k Ω (min) k Ω (max)
P_O	Output Power	THD+N = 1% (max); f = 1kHz, one channel	95		mW
		THD+N = 1% (max); f = 1kHz, $R_L = 32\Omega$, one channel	80		mW
		THD+N = 1% (max); f = 1kHz, two channels in phase	50	40	mW (min)
		THD+N = 1% (max); f = 1kHz, $R_L = 32\Omega$, two channels in phase	55	45	mW (min)
THD+N	Total Harmonic Distortion + Noise	$P_O = 60mW$, f = 1kHz, single channel	0.01		%
		$P_O = 50mW$, f = 1kHz, $R_L = 32\Omega$ single channel	0.007		%
PSRR	Power Supply Rejection Ratio Full Power Mode	$V_{RIPPLE} = 200mV_{P-P}$, Input Referred	80		dB dB dB
		f = 217Hz	75		
		f = 1kHz f = 20kHz	58		
SNR	Signal-to-Noise Ratio	$R_L = 32\Omega$, $P_O = 20mW$, (A-weighted) f = 1kHz, BW = 20Hz to 22kHz	100		dB
V_{IH}	Shutdown Input Voltage High	$V_{DD} = 1.8V$ to 4.2V		1.2	V (min)
V_{IL}	Shutdown Input Voltage Low	$V_{DD} = 1.8V$ to 4.2V		0.45	V (max)
X_{TALK}	Crosstalk	$P_O = 1.6mW$, f = 1kHz	70		dB
Z_{OUT}	Output Impedance	$\overline{SD_LC} = \overline{SD_RC} = GND$ Input Terminated	30	25	k Ω (min)
		Input not terminated	30		
Z_{OUT}	Output Impedance	$\overline{SD_LC} = \overline{SD_RC} = GND$ -500mV $\leq V_{OUT} \leq V_{DD} + 500mV$ (6)	8	2	k Ω (min)
I_L	Input Leakage		± 0.1		nA

(6) V_{OUT} refers to signal applied to the LM48820 outputs.

External Components Description

([Figure 1](#))

Components		Functional Description
1.	$C_{INR/INL}$	Input coupling capacitor which blocks the DC voltage at the amplifier's input terminals. Also creates a high-pass filter with R_i at $f_C = 1/(2\pi R_i C_{IN})$. Refer to the section SELECTING PROPER EXTERNAL COMPONENTS , for an explanation of how to determine the value of C_i .
2.	C_C	Flying capacitor. Low ESR ceramic capacitor ($\leq 100m\Omega$)
3.	C_{SS}	Output capacitor. Low ESR ceramic capacitor ($\leq 100m\Omega$)
4.	C_{S1}	Tantalum capacitor. Supply bypass capacitor which provides power supply filtering. Refer to the POWER SUPPLY BYPASSING section for information concerning proper placement and selection of the supply bypass capacitor.
5.	C_{S2}	Ceramic capacitor. Supply bypass capacitor which provides power supply filtering. Refer to the POWER SUPPLY BYPASSING section for information concerning proper placement and selection of the supply bypass capacitor.

Typical Performance Characteristics

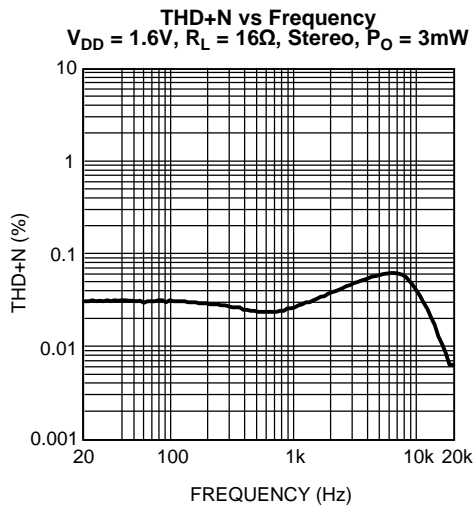

Figure 4.

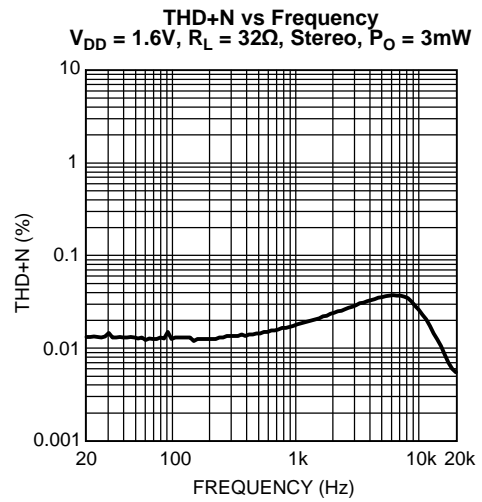

Figure 5.

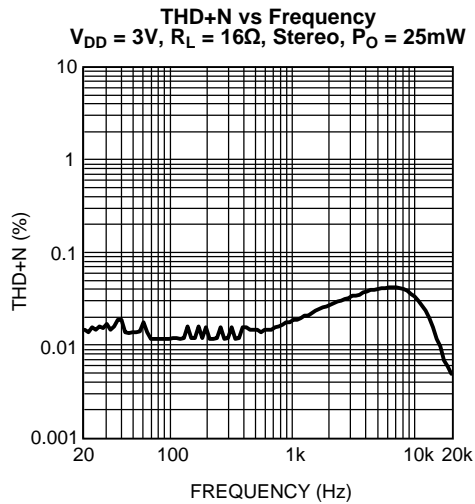

Figure 6.

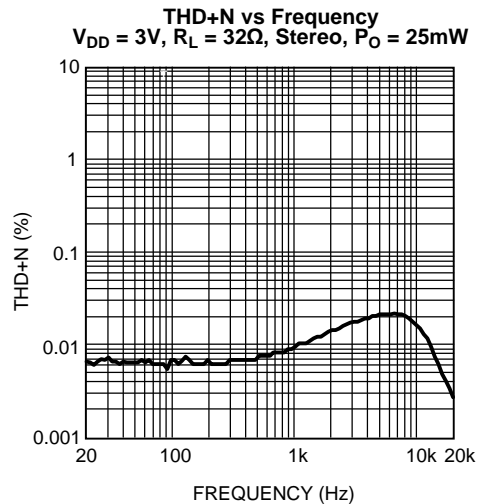

Figure 7.

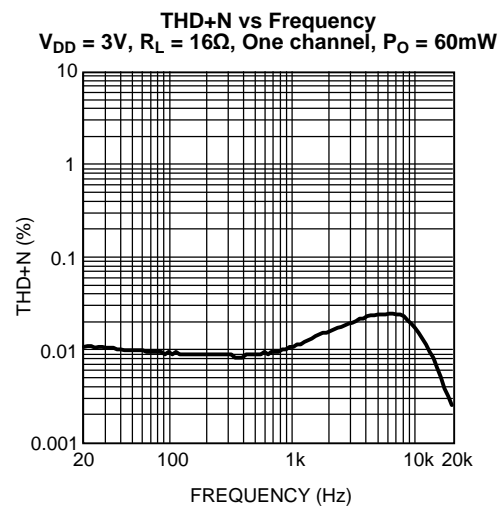

Figure 8.

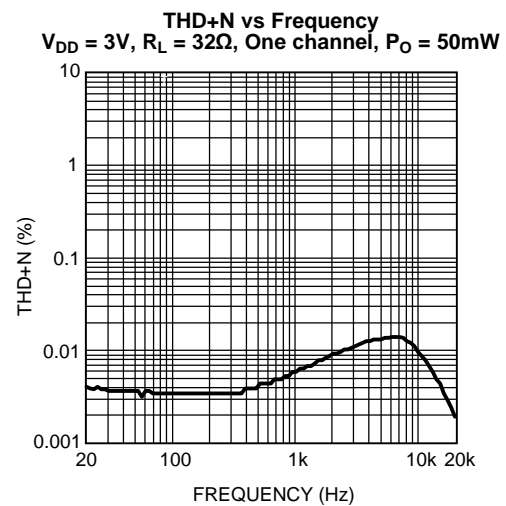

Figure 9.

Typical Performance Characteristics (continued)

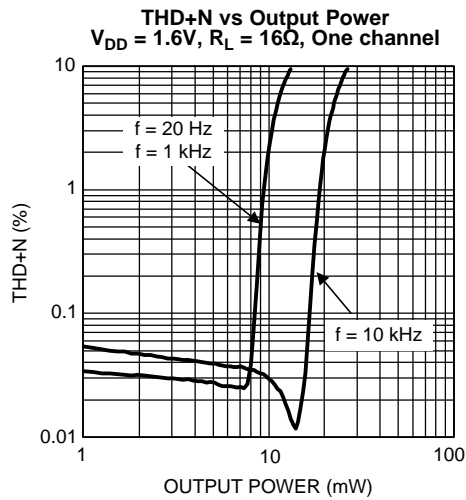

Figure 10.

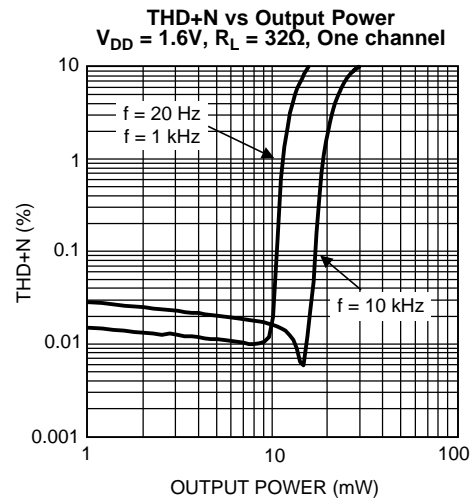

Figure 11.

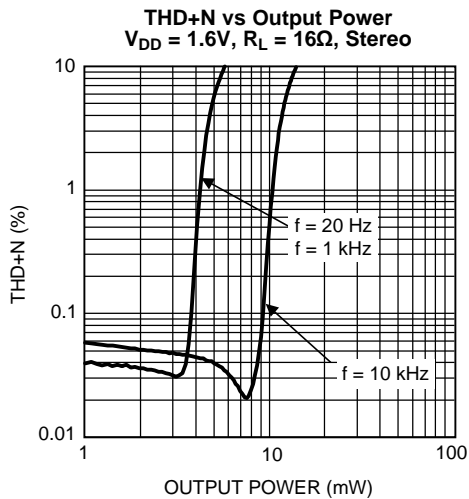

Figure 12.

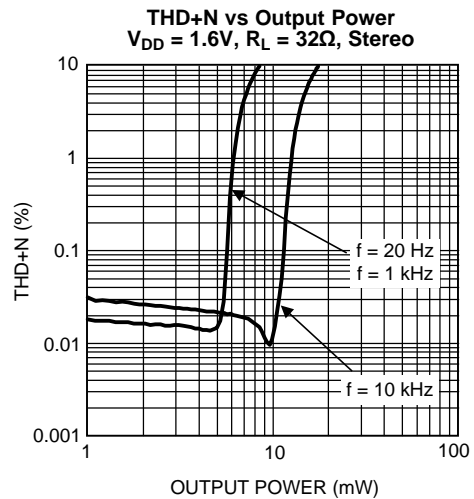

Figure 13.

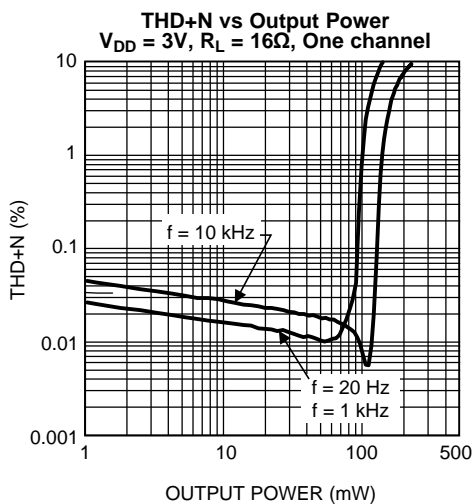

Figure 14.

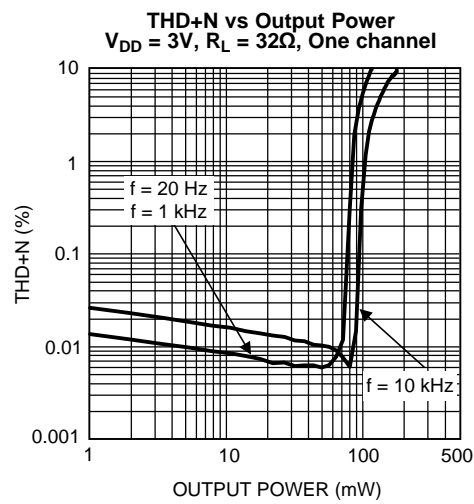

Figure 15.

Typical Performance Characteristics (continued)

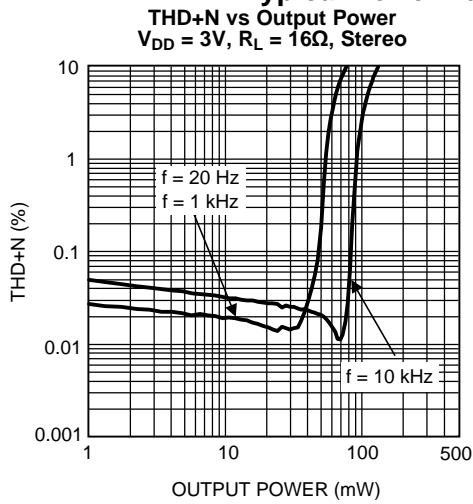

Figure 16.

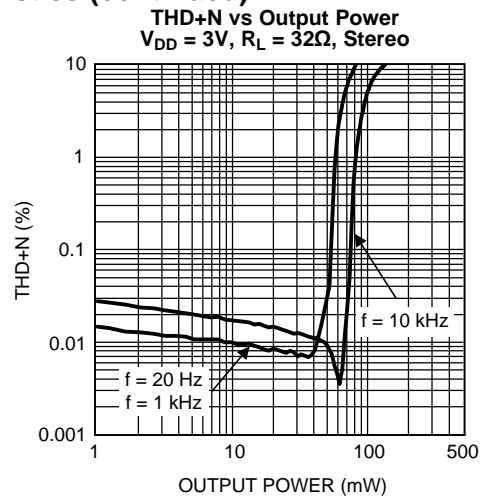

Figure 17.

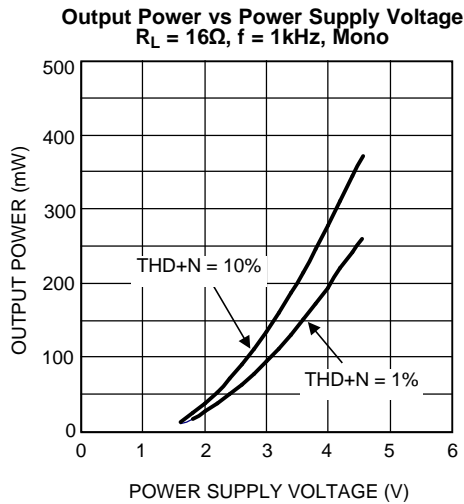

Figure 18.

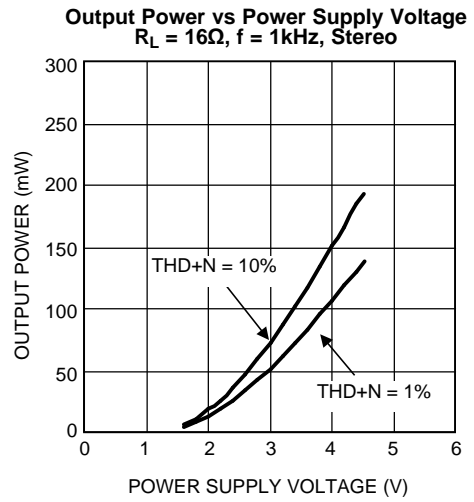

Figure 19.

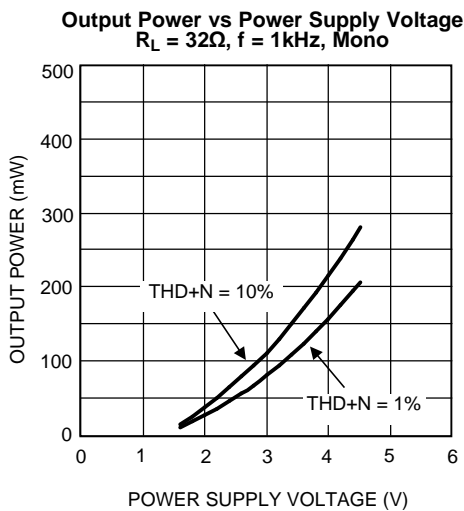

Figure 20.

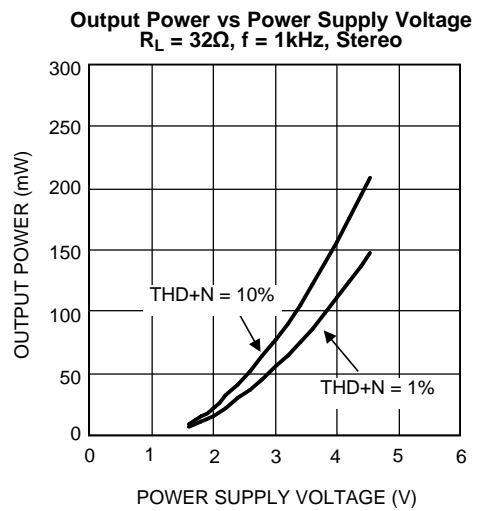

Figure 21.

Typical Performance Characteristics (continued)

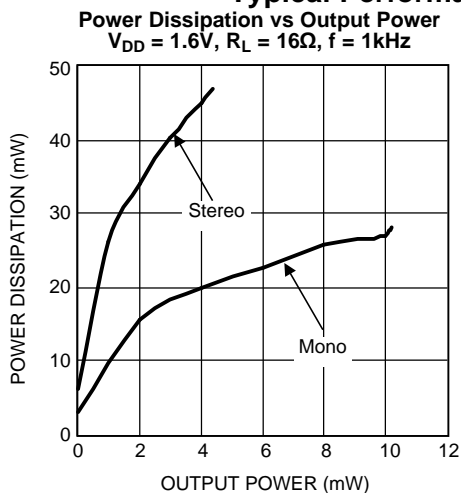

Figure 22.

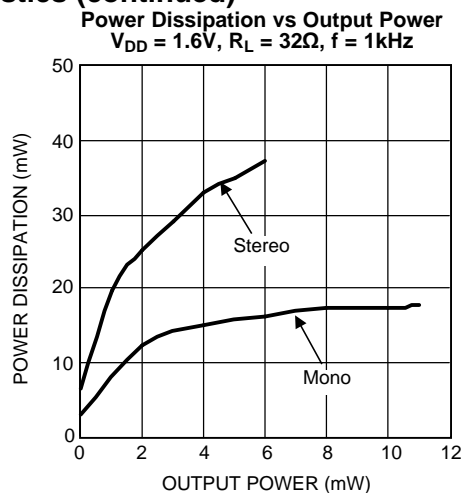

Figure 23.

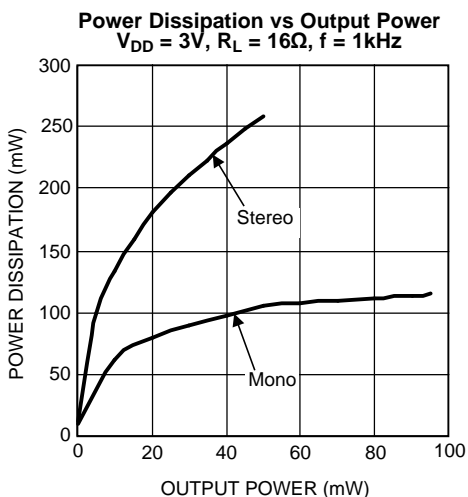

Figure 24.

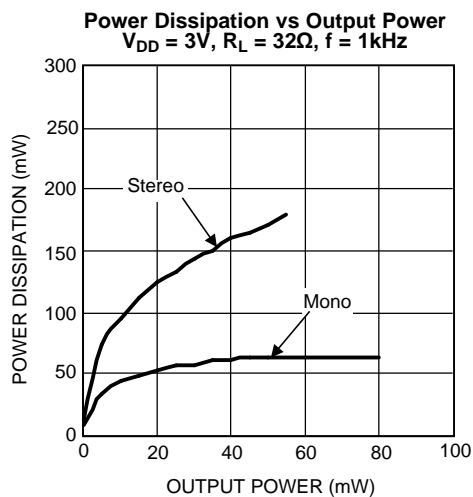

Figure 25.

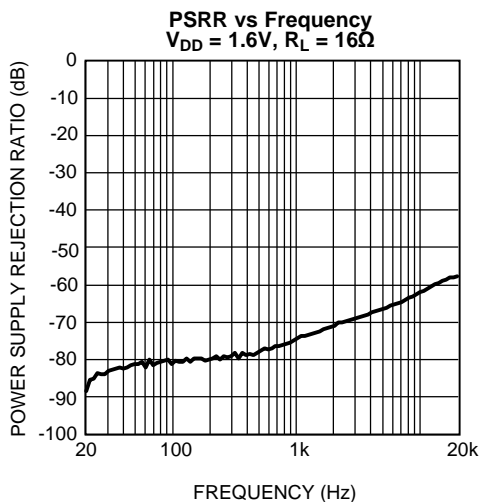

Figure 26.

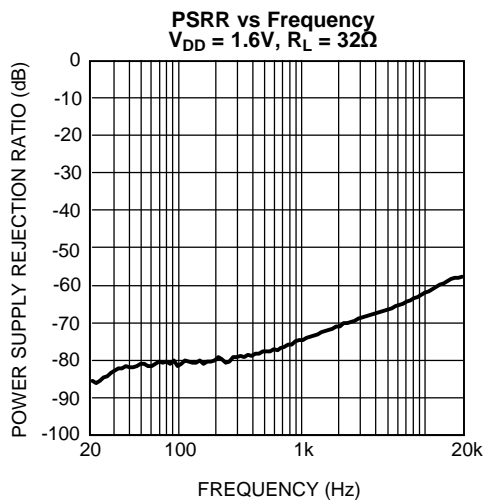

Figure 27.

Typical Performance Characteristics (continued)

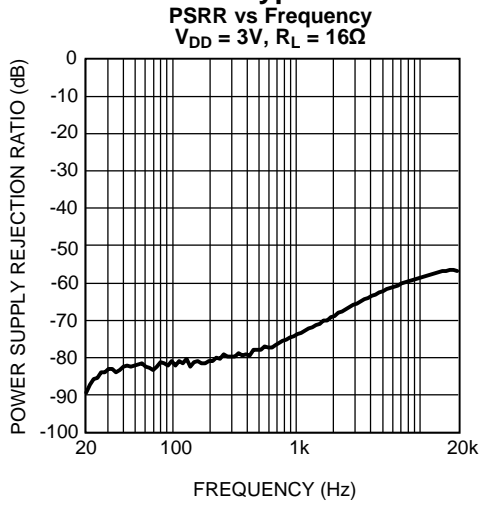

Figure 28.

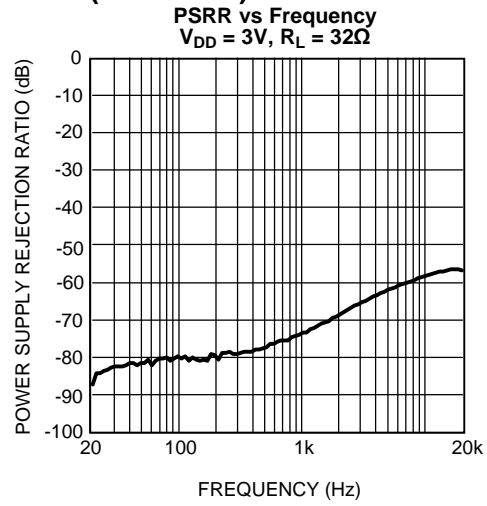

Figure 29.

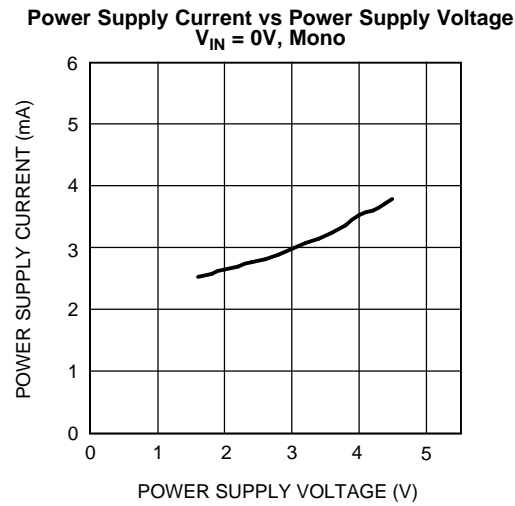

Figure 30.

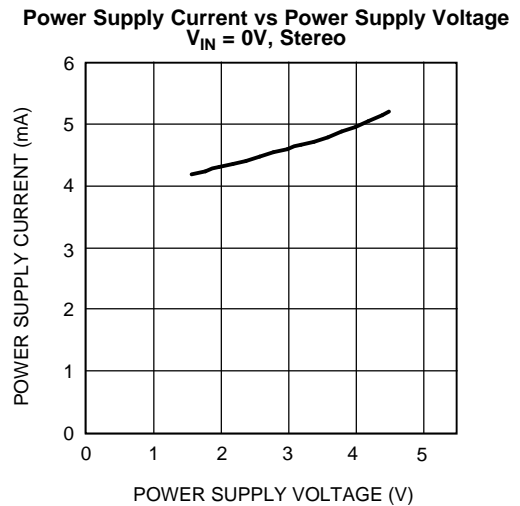

Figure 31.

APPLICATION INFORMATION

SUPPLY VOLTAGE SEQUENCING

Before applying any signal to the inputs or shutdown pins of the LM48820, it is important to apply a supply voltage to the V_{DD} pins. After the device has been powered, signals may be applied to the shutdown pins (see [MICRO POWER SHUTDOWN](#)) and input pins.

ELIMINATING THE OUTPUT COUPLING CAPACITOR

The LM48820 features a low noise inverting charge pump that generates an internal negative supply voltage. This allows the outputs of the LM48820 to be biased about GND instead of a nominal DC voltage, like traditional headphone amplifiers. Because there is no DC component, the large DC blocking capacitors (typically 220 μ F) are not necessary. The coupling capacitors are replaced by two, small ceramic charge pump capacitors, saving board space and cost.

Eliminating the output coupling capacitors also improves low frequency response. In traditional headphone amplifiers, the headphone impedance and the output capacitor form a high pass filter that not only blocks the DC component of the output, but also attenuates low frequencies, impacting the bass response. Because the LM48820 does not require the output coupling capacitors, the low frequency response of the device is not degraded by external components.

In addition to eliminating the output coupling capacitors, the ground referenced output nearly doubles the available dynamic range of the LM48820 when compared to a traditional headphone amplifier operating from the same supply voltage.

OUTPUT TRANSIENT ('CLICK AND POPS') ELIMINATED

The LM48820 contains advanced circuitry that virtually eliminates output transients ('clicks and pops'). This circuitry prevents all traces of transients when the supply voltage is first applied or when the part resumes operation after coming out of shutdown mode.

AMPLIFIER CONFIGURATION EXPLANATION

As shown in [Figure 1](#), the LM48820 has two internal operational amplifiers. The two amplifiers have internally configured gain, the closed loop gain is set by selecting the ratio of R_f to R_i . Consequently, the gain for each channel of the IC is

$$A_V = -(R_f / R_i) = 1.5 \text{ (V/V)}$$

where

- $R_f = 30\text{k}\Omega$
- $R_i = 20\text{k}\Omega$

(1)

POWER DISSIPATION

Power dissipation is a major concern when using any power amplifier and must be thoroughly understood to ensure a successful design. [Equation 2](#) states the maximum power dissipation point for a single-ended amplifier operating at a given supply voltage and driving a specified output load.

$$P_{DMAX} = (V_{DD})^2 / (2\pi^2 R_L) \text{ (W)}$$
 (2)

Since the LM48820 has two operational amplifiers in one package, the maximum internal power dissipation point is twice that of the number which results from [Equation 2](#). Even with large internal power dissipation, the LM48820 does not require heat sinking over a large range of ambient temperatures. From [Equation 2](#), assuming a 3V power supply and a 16 Ω load, the maximum power dissipation point is 28mW per amplifier. Thus the maximum package dissipation point is 56mW. The maximum power dissipation point obtained must not be greater than the power dissipation that results from [Equation 3](#):

$$P_{DMAX} = (T_{JMAX} - T_A) / (\theta_{JA}) \text{ (W)}$$
 (3)

For this DSBGA package, $\theta_{JA} = 86^{\circ}\text{C/W}$ and $T_{JMAX} = 150^{\circ}\text{C}$. Depending on the ambient temperature, T_A , of the system surroundings, Equation 3 can be used to find the maximum internal power dissipation supported by the IC packaging. If the result of Equation 2 is greater than that of Equation 3, then either the supply voltage must be decreased, the load impedance increased or T_A reduced. For the typical application of a 3V power supply, with a 16 Ω load, the maximum ambient temperature possible without violating the maximum junction temperature is approximately 127 $^{\circ}\text{C}$ provided that device operation is around the maximum power dissipation point. Power dissipation is a function of output power and thus, if typical operation is not around the maximum power dissipation point, the ambient temperature may be increased accordingly.

POWER SUPPLY BYPASSING

As with any power amplifier, proper supply bypassing is critical for low noise performance and high power supply rejection. Applications that employ a 3V power supply typically use a 4.7 μF capacitor in parallel with a 0.1 μF ceramic filter capacitor to stabilize the power supply output, reduce noise on the supply line, and improve the supply's transient response. Keep the length of leads and traces that connect capacitors between the LM48820's power supply pin and ground as short as possible.

MICRO POWER SHUTDOWN

The voltage applied to the $\overline{\text{SD_LC}}$ (shutdown left channel) pin and the $\overline{\text{SD_RC}}$ (shutdown right channel) pin controls the LM48820's shutdown function. When active, the LM48820's micropower shutdown feature turns off the amplifiers' bias circuitry, reducing the supply current. The trigger point is 0.45V (max) for a logic-low level, and 1.2V (min) for logic-high level. The low 0.05 μA (typ) shutdown current is achieved by applying a voltage that is as near as ground a possible to the $\overline{\text{SD_LC}}/\overline{\text{SD_RC}}$ pins. A voltage that is higher than ground may increase the shutdown current.

There are a few ways to control the micro-power shutdown. These include using a single-pole, single-throw switch, a microprocessor, or a microcontroller. When using a switch, connect an external 100k Ω pull-up resistor between the $\overline{\text{SD_LC}}/\overline{\text{SD_RC}}$ pins and V_{DD} . Connect the switch between the $\overline{\text{SD_LC}}/\overline{\text{SD_RC}}$ pins and ground. Select normal amplifier operation by opening the switch. Closing the switch connects the $\overline{\text{SD_LC}}/\overline{\text{SD_RC}}$ pins to ground, activating micro-power shutdown. The switch and resistor ensure that the $\overline{\text{SD_LC}}/\overline{\text{SD_RC}}$ pins will not float. This prevents unwanted state changes. In a system with a microprocessor or microcontroller, use a digital output to apply the control voltage to the $\overline{\text{SD_LC}}/\overline{\text{SD_RC}}$ pins. Driving the $\overline{\text{SD_LC}}/\overline{\text{SD_RC}}$ pins with active circuitry eliminates the pull-up resistor.

SELECTING PROPER EXTERNAL COMPONENTS

Optimizing the LM48820's performance requires properly selecting external components. Though the LM48820 operates well when using external components with wide tolerances, best performance is achieved by optimizing component values.

Charge Pump Capacitor Selection

Use low (<100m Ω) ESR (equivalent series resistance) ceramic capacitors with an X7R dielectric for best performance. Low ESR capacitors keep the charge pump output impedance to a minimum, extending the headroom on the negative supply. Higher ESR capacitors result in reduced output power from the audio amplifiers.

Charge pump load regulation and output impedance are affected by the value of the flying capacitor (C_C). A larger valued C_C (up to 3.3 μF) improves load regulation and minimizes charge pump output resistance. The switch-on resistance dominates the output impedance for capacitor values above 2.2 μF .

The output ripple is affected by the value and ESR of the output capacitor (C_{SS}). Larger capacitors reduce output ripple on the negative power supply. Lower ESR capacitors minimize the output ripple and reduce the output impedance of the charge pump.

The LM48820 charge pump design is optimized for 2.2 μF , low ESR, ceramic, flying, and output capacitors.

Input Capacitor Value Selection

Amplifying the lowest audio frequencies requires high value input coupling capacitors (C_{INL} and C_{INR} in [Figure 1](#)). A high value capacitor can be expensive and may compromise space efficiency in portable designs. In many cases, however, the speakers used in portable systems, whether internal or external, have little ability to reproduce signals below 150Hz. Applications using speakers with this limited frequency response reap little improvement by using high value input and output capacitors.

Besides affecting system cost and size, the input coupling capacitor has an effect on the LM48820's click and pop performance. The magnitude of the pop is directly proportional to the input capacitor's size. Thus, pops can be minimized by selecting an input capacitor value that is no higher than necessary to meet the desired -3dB frequency.

As shown in [Figure 1](#), the internal input resistor, R_i and the input capacitor, C_{INL} and C_{INR} , produce a -3dB high pass filter cutoff frequency that is found using [Equation 4](#).

$$f_{-3dB} = 1 / 2\pi R_i C_{IN} \text{ (Hz)} \quad (4)$$

Also, careful consideration must be taken in selecting a certain type of capacitor to be used in the system. Different types of capacitors (tantalum, electrolytic, ceramic) have unique performance characteristics and may affect overall system performance.

REVISION HISTORY

Rev	Date	Description
1.0	05/09/07	Initial release.
1.1	05/15/07	Added the BOM table.
1.2	06/25/07	Deleted and replaced some curves. Input text edits also.
B	05/02/2013	Changed layout of National Data Sheet to TI format

PACKAGING INFORMATION

Orderable Device	Status (1)	Package Type	Package Drawing	Pins	Package Qty	Eco Plan (2)	Lead finish/ Ball material (6)	MSL Peak Temp (3)	Op Temp (°C)	Device Marking (4/5)	Samples
LM48820TM/NOPB	ACTIVE	DSBGA	YFR	14	250	RoHS & Green	SNAGCU	Level-1-260C-UNLIM	-40 to 85	GI7	Samples
LM48820TMX/NOPB	ACTIVE	DSBGA	YFR	14	3000	RoHS & Green	SNAGCU	Level-1-260C-UNLIM	-40 to 85	GI7	Samples

(1) The marketing status values are defined as follows:

ACTIVE: Product device recommended for new designs.

LIFEBUY: TI has announced that the device will be discontinued, and a lifetime-buy period is in effect.

NRND: Not recommended for new designs. Device is in production to support existing customers, but TI does not recommend using this part in a new design.

PREVIEW: Device has been announced but is not in production. Samples may or may not be available.

OBSOLETE: TI has discontinued the production of the device.

(2) **RoHS:** TI defines "RoHS" to mean semiconductor products that are compliant with the current EU RoHS requirements for all 10 RoHS substances, including the requirement that RoHS substance do not exceed 0.1% by weight in homogeneous materials. Where designed to be soldered at high temperatures, "RoHS" products are suitable for use in specified lead-free processes. TI may reference these types of products as "Pb-Free".

RoHS Exempt: TI defines "RoHS Exempt" to mean products that contain lead but are compliant with EU RoHS pursuant to a specific EU RoHS exemption.

Green: TI defines "Green" to mean the content of Chlorine (Cl) and Bromine (Br) based flame retardants meet JS709B low halogen requirements of <=1000ppm threshold. Antimony trioxide based flame retardants must also meet the <=1000ppm threshold requirement.

(3) MSL, Peak Temp. - The Moisture Sensitivity Level rating according to the JEDEC industry standard classifications, and peak solder temperature.

(4) There may be additional marking, which relates to the logo, the lot trace code information, or the environmental category on the device.

(5) Multiple Device Markings will be inside parentheses. Only one Device Marking contained in parentheses and separated by a "~" will appear on a device. If a line is indented then it is a continuation of the previous line and the two combined represent the entire Device Marking for that device.

(6) Lead finish/Ball material - Orderable Devices may have multiple material finish options. Finish options are separated by a vertical ruled line. Lead finish/Ball material values may wrap to two lines if the finish value exceeds the maximum column width.

Important Information and Disclaimer:The information provided on this page represents TI's knowledge and belief as of the date that it is provided. TI bases its knowledge and belief on information provided by third parties, and makes no representation or warranty as to the accuracy of such information. Efforts are underway to better integrate information from third parties. TI has taken and continues to take reasonable steps to provide representative and accurate information but may not have conducted destructive testing or chemical analysis on incoming materials and chemicals. TI and TI suppliers consider certain information to be proprietary, and thus CAS numbers and other limited information may not be available for release.

In no event shall TI's liability arising out of such information exceed the total purchase price of the TI part(s) at issue in this document sold by TI to Customer on an annual basis.

TAPE AND REEL INFORMATION

QUADRANT ASSIGNMENTS FOR PIN 1 ORIENTATION IN TAPE

*All dimensions are nominal

Device	Package Type	Package Drawing	Pins	SPQ	Reel Diameter (mm)	Reel Width W1 (mm)	A0 (mm)	B0 (mm)	K0 (mm)	P1 (mm)	W (mm)	Pin1 Quadrant
LM48820TM/NOPB	DSBGA	YFR	14	250	178.0	8.4	1.7	1.7	0.76	4.0	8.0	Q1
LM48820TMX/NOPB	DSBGA	YFR	14	3000	178.0	8.4	1.7	1.7	0.76	4.0	8.0	Q1

TAPE AND REEL BOX DIMENSIONS

*All dimensions are nominal

Device	Package Type	Package Drawing	Pins	SPQ	Length (mm)	Width (mm)	Height (mm)
LM48820TM/NOPB	DSBGA	YFR	14	250	208.0	191.0	35.0
LM48820TMX/NOPB	DSBGA	YFR	14	3000	208.0	191.0	35.0

YFR0014

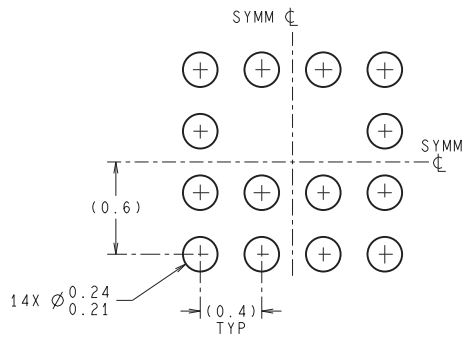

LAND PATTERN RECOMMENDATION

DIMENSIONS ARE IN MILLIMETERS
DIMENSIONS IN () FOR REFERENCE ONLY

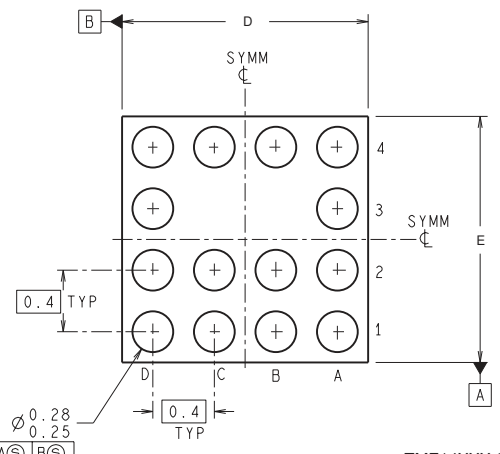
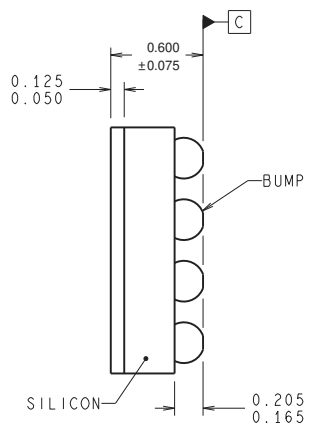
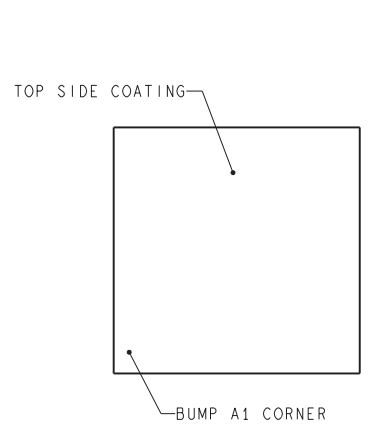

⊕	0.005	Ⓢ	C	A	Ⓢ	B	Ⓢ
---	-------	---	---	---	---	---	---

TME14XXX (Rev A)

D: Max = 1.64 mm, Min = 1.58 mm

E: Max = 1.64 mm, Min = 1.58 mm

4215090/A 12/12

NOTES: A. All linear dimensions are in millimeters. Dimensioning and tolerancing per ASME Y14.5M-1994.
B. This drawing is subject to change without notice.

IMPORTANT NOTICE AND DISCLAIMER

TI PROVIDES TECHNICAL AND RELIABILITY DATA (INCLUDING DATA SHEETS), DESIGN RESOURCES (INCLUDING REFERENCE DESIGNS), APPLICATION OR OTHER DESIGN ADVICE, WEB TOOLS, SAFETY INFORMATION, AND OTHER RESOURCES "AS IS" AND WITH ALL FAULTS, AND DISCLAIMS ALL WARRANTIES, EXPRESS AND IMPLIED, INCLUDING WITHOUT LIMITATION ANY IMPLIED WARRANTIES OF MERCHANTABILITY, FITNESS FOR A PARTICULAR PURPOSE OR NON-INFRINGEMENT OF THIRD PARTY INTELLECTUAL PROPERTY RIGHTS.

These resources are intended for skilled developers designing with TI products. You are solely responsible for (1) selecting the appropriate TI products for your application, (2) designing, validating and testing your application, and (3) ensuring your application meets applicable standards, and any other safety, security, regulatory or other requirements.

These resources are subject to change without notice. TI grants you permission to use these resources only for development of an application that uses the TI products described in the resource. Other reproduction and display of these resources is prohibited. No license is granted to any other TI intellectual property right or to any third party intellectual property right. TI disclaims responsibility for, and you will fully indemnify TI and its representatives against, any claims, damages, costs, losses, and liabilities arising out of your use of these resources.

TI's products are provided subject to [TI's Terms of Sale](#) or other applicable terms available either on [ti.com](https://www.ti.com) or provided in conjunction with such TI products. TI's provision of these resources does not expand or otherwise alter TI's applicable warranties or warranty disclaimers for TI products.

TI objects to and rejects any additional or different terms you may have proposed.

Mailing Address: Texas Instruments, Post Office Box 655303, Dallas, Texas 75265
Copyright © 2023, Texas Instruments Incorporated