

## Features

- Very Low FOM  $R_{DS(on)} \times Q_g$
- Halogen Free. "Green" Device (Note 1)
- Epoxy Meets UL 94 V-0 Flammability Rating
- Lead Free Finish/RoHS Compliant ("P" Suffix Designates RoHS Compliant. See Ordering Information)

## Maximum Ratings

- Operating Junction Temperature Range : -55°C to +150°C
- Storage Temperature Range: -55°C to +150°C
- Thermal Resistance: 5.7°C/W Junction to Case<sup>(Note2)</sup>

Parameter	Symbol	Rating	Unit
Drain-Source Voltage	$V_{DS}$	650	V
Gate-Source Voltage	$V_{GS}$	±30	V
Continuous Drain Current	$I_D$	20	A
Pulsed Drain Current <sup>(3)</sup>	$I_{DM}$	60	A
Total Power Dissipation	$P_D$	34	W
Single Pulsed Avalanche Energy <sup>(4)</sup>	$E_{AS}$	485	mJ

Note:

1. Halogen free "Green" products are defined as those which contain <900ppm bromine, <900ppm chlorine (<1500ppm total Br + Cl) and <1000ppm antimony compounds.
2. Surface Mounted on 1 in<sup>2</sup> pad area, t ≤ 10 sec
3. Pulse Test: Pulse Width ≤ 300us, Duty cycle ≤ 2%.

## Internal Structure and Marking Code

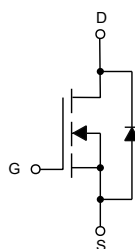

1. Gate
2. Drain
3. Source

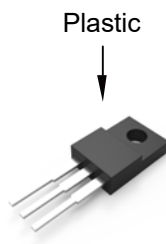
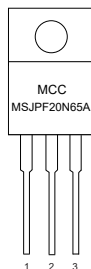

# N-CHANNEL MOSFET

## TO-220F

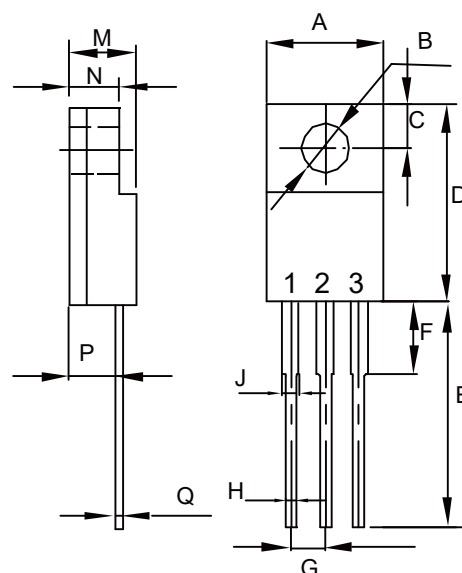

DIM	INCHES		MM		NOTE
	MIN	MAX	MIN	MAX	
A	0.390	0.421	9.90	10.70	
B	0.122	0.130	3.10	3.30	Φ
C	0.106		2.70		TYP.
D	0.567	0.642	14.40	16.30	
E	0.630	0.661	16.00	16.80	
F	0.134	0.150	3.40	3.80	
G	0.092	0.108	2.34	2.74	
H	0.020	0.035	0.50	0.90	
J	0.043	0.056	1.10	1.42	
M	0.169	0.201	4.30	5.10	
N	0.096	0.104	2.45	2.65	
P	0.083	0.126	2.10	3.20	
Q	0.016	0.032	0.40	0.80	

**Electrical Characteristics @ 25°C (Unless Otherwise Specified)**

Parameter	Symbol	Test Conditions	Min	Typ	Max	Unit
<b>Static Characteristics</b>						
Drain-Source Breakdown Voltage	$V_{(BR)DSS}$	$V_{GS}=0V, I_D=250\mu A$	650			V
Gate-Source Leakage Current	$I_{GSS}$	$V_{DS}=0V, V_{GS}=\pm 30V$			$\pm 100$	nA
Zero Gate Voltage Drain Current	$I_{DSS}$	$V_{DS}=650V, V_{GS}=0V, T_C=25^\circ C$			1	$\mu A$
Gate-Threshold Voltage <sup>(Note 4)</sup>	$V_{GS(th)}$	$V_{DS}=V_{GS}, I_D=250\mu A$	2	3	4	V
Drain-Source On-Resistance <sup>(Note 4)</sup>	$R_{DS(on)}$	$V_{GS}=10V, I_D=10A$		167	180	m $\Omega$
Gate Resistance <sup>(Note 4)</sup>	$R_G$	f = 1.0MHz Open Drain		2.2		$\Omega$
<b>Dynamic Characteristics <sup>(Note 5)</sup></b>						
Input Capacitance	$C_{iss}$	$V_{DS}=25V, V_{GS}=0V, f=1MHz$		1807		pF
Output Capacitance	$C_{oss}$			1214		
Reverse Transfer Capacitance	$C_{rss}$			103		
Total Gate Charge	$Q_g$	$V_{DS}=560V, V_{GS}=10V, I_D=20A$		56		nC
Gate-Source Charge	$Q_{gs}$			12		
Gate-Drain Charge	$Q_{gd}$			25		
Turn-On Delay Time	$t_{d(on)}$	$V_{DD}=350V, I_D=20A$ $V_{GS}=10V, R_{GEN}=25\Omega$		30		ns
Turn-On Rise Time	$t_r$			55		
Turn-Off Delay Time	$t_{d(off)}$			167		
Turn-Off Fall Time	$t_f$			103		
<b>Drain-Source Diode Characteristics</b>						
Diode Forward Voltage	$V_{SD}$	$V_{GS}=0V, I_S=20A$			1.4	V
Continuous Body Diode Current	$I_S$				20	A
Reverse Recovery Time	$t_{rr}$	$V_{DD}=100V,$ $I_S=11A,$ $di_f/dt = 100A/\mu s$		332		ns
Reverse Recovery Charge	$Q_{rr}$			4901		nC
Peak Reverse Recovery Current	$I_{rrm}$			31		A

Note:

- 4. Pulse Test: Pulse Width  $\leq 300\mu s$ , Duty Cycle  $\leq 1\%$ .
- 5. Guaranteed by Design, not Subject to Production.

Fig. 1 - Typical Output Characteristics

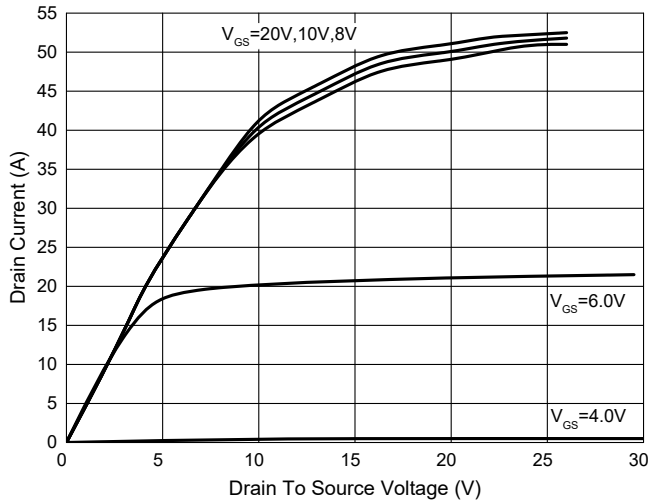

Fig. 2 - Normalized On Resistance Characteristics

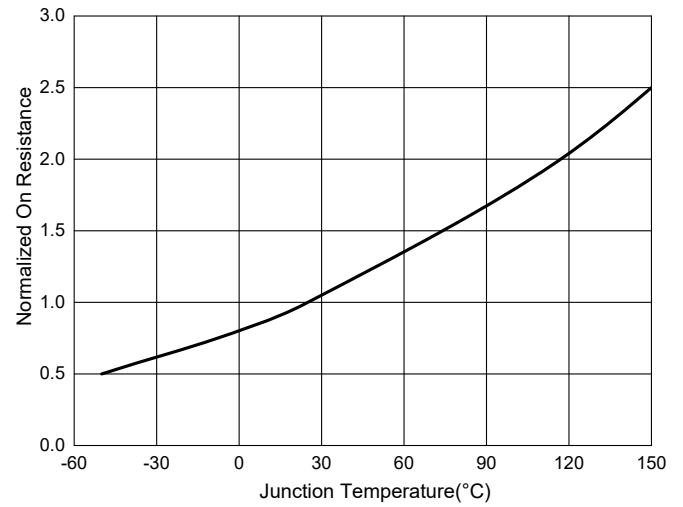

Fig. 3 -  $R_{DS(ON)}$  vs  $I_D$

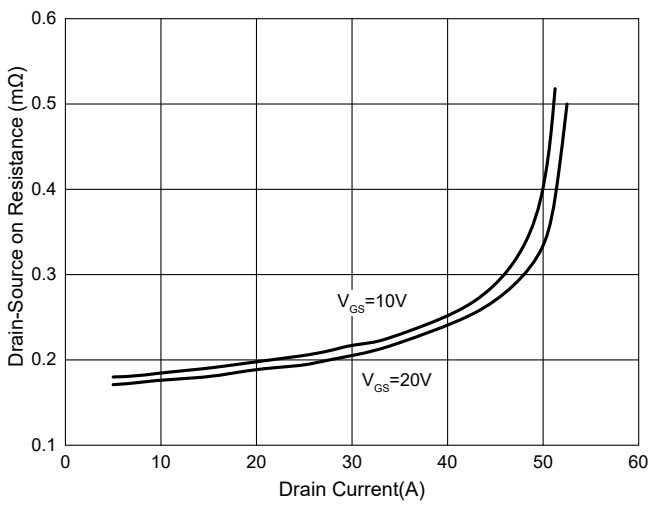

Fig. 4 - Capacitance Characteristics

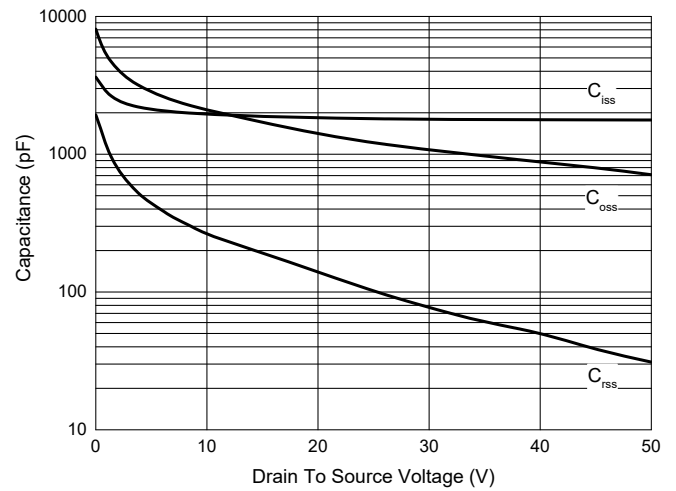

Fig. 5- Gate Charge

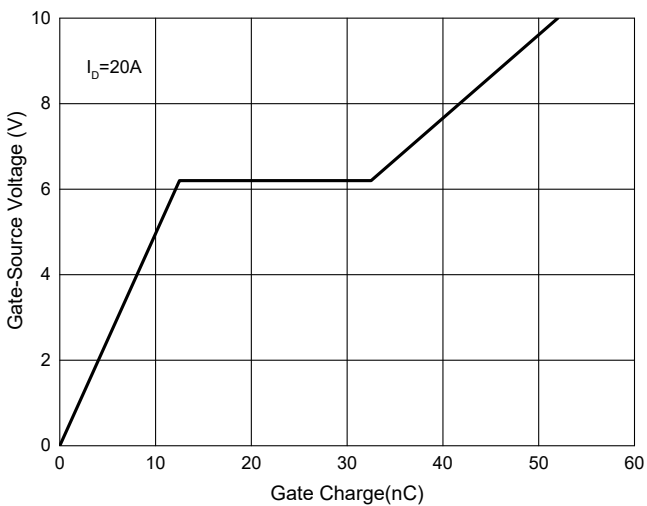

Fig. 6 - Normalized On Resistance Characteristics

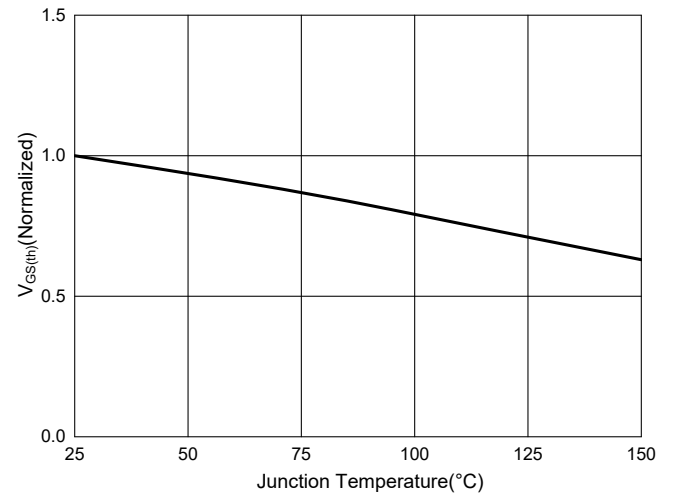
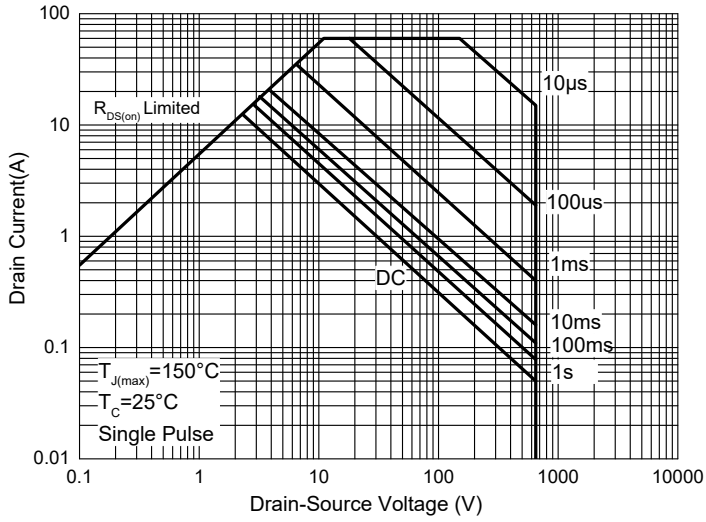

Fig. 7 - Safe Operation Area



## Ordering Information

Device	Packing
Part Number-BP	Bulk: 50pcs/Tube; 1Kpcs/Box; 5Kpcs/Ctn

**\*\*\*IMPORTANT NOTICE\*\*\***

*Micro Commercial Components Corp.* reserves the right to make changes without further notice to any product herein to make corrections, modifications, enhancements, improvements, or other changes. *Micro Commercial Components Corp.* does not assume any liability arising out of the application or use of any product described herein; neither does it convey any license under its patent rights, nor the rights of others. The user of products in such applications shall assume all risks of such use and will agree to hold *Micro Commercial Components Corp.* and all the companies whose products are represented on our website, harmless against all damages. *Micro Commercial Components Corp.* products are sold subject to the general terms and conditions of commercial sale, as published at <https://www.mccsemi.com/Home/TermsAndConditions>.

**\*\*\*LIFE SUPPORT\*\*\***

MCC's products are not authorized for use as critical components in life support devices or systems without the express written approval of Micro Commercial Components Corporation.

**\*\*\*CUSTOMER AWARENESS\*\*\***

Counterfeiting of semiconductor parts is a growing problem in the industry. Micro Commercial Components (MCC) is taking strong measures to protect ourselves and our customers from the proliferation of counterfeit parts. MCC strongly encourages customers to purchase MCC parts either directly from MCC or from Authorized MCC Distributors who are listed by country on our web page cited below. Products customers buy either from MCC directly or from Authorized MCC Distributors are genuine parts, have full traceability, meet MCC's quality standards for handling and storage. **MCC will not provide any warranty coverage or other assistance for parts bought from Unauthorized Sources.** MCC is committed to combat this global problem and encourage our customers to do their part in stopping this practice by buying direct or from authorized distributors.