

10 9 8 7 6 5 4 3 2 1

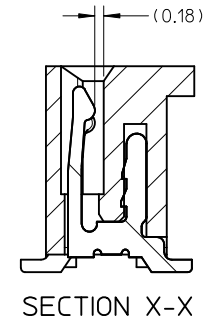
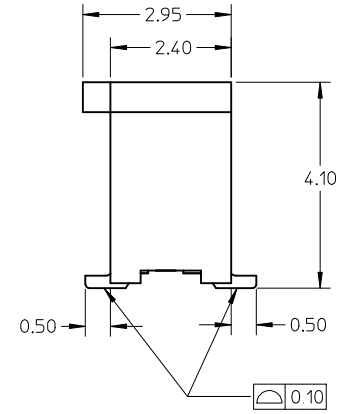
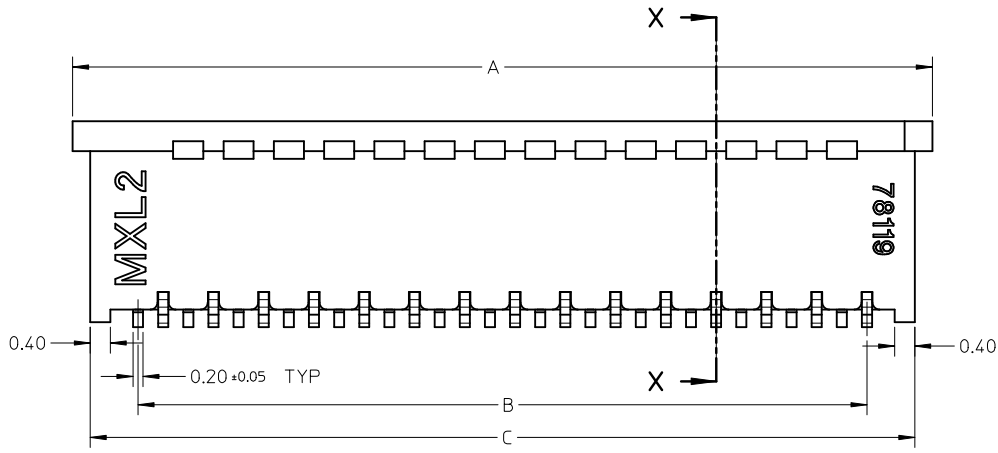
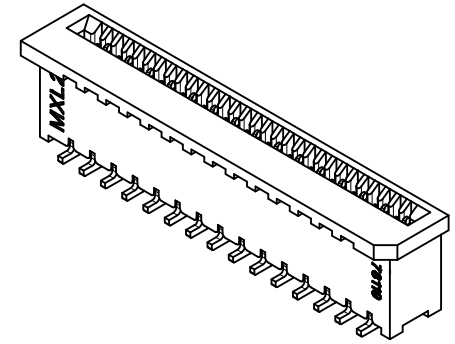
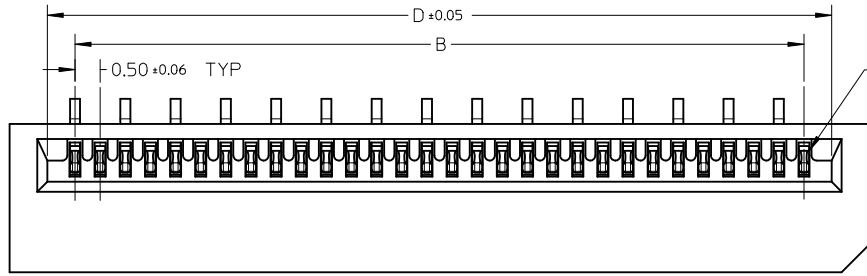

NOTE:  
 1. MATERIAL:  
 HOUSING: PA46 GLASS FILLED, UL94V-0, COLOR: NATURAL  
 TERMINAL: COPPER ALLOY  
 2. PLATING: 1) 0.10 μm MIN. GOLD PLATING OVER NICKEL PLATING OVERALL  
 2) 1-3 μm TIN-BISMUTH OVER NICKEL PLATING OVERALL  
 3. PRODUCT SPECIFICATION: PS-78119-001  
 4. PRODUCT ARE PACKED IN TAPE & REEL.

REVISED	IEC NO: J2012-1253	2012/03/23	DESCRIPTION
	DR:WAKIYAHARA	2012/03/26	
	CH:KDKTAKAHASHI	2012/03/26	
	APP:KIMORIYAMA	2012/03/30	
REV			

QUALITY SYMBOLS	▽=0		
	◻=0		
	GENERAL TOLERANCES (UNLESS SPECIFIED)		
		mm	INCH
	4 PLACES	± ---	± ---
3 PLACES	± ---	± ---	
2 PLACES	± 0.15	± ---	
1 PLACE	± ---	± ---	
ANGULAR ± 3 °			
DRAFT WHERE APPLICABLE MUST REMAIN WITHIN DIMENSIONS			

DIMENSION STYLE		SCALE	DESIGN UNITS
MM ONLY		NTS	METRIC
DRAWN BY	DATE	TITLE	
YLOIAO	2006/04/11	0.50MM PITCH, FPC CONN. NON-ZIF, SMT	
CHECKED BY	DATE		
BOKOK	2006/04/18	MOLEX INCORPORATED	
APPROVED BY	DATE		
PTLIM	2006/04/18	SD-78119-001	
MATERIAL NO.	DOCUMENT NO.		
SEE TABLE		SHEET NO. 1 OF 7	

THIRD ANGLE PROJECTION	
MOLEX INCORPORATED	
SD-78119-001	
THIS DRAWING CONTAINS INFORMATION THAT IS PROPRIETARY TO MOLEX INCORPORATED AND SHOULD NOT BE USED WITHOUT WRITTEN PERMISSION	

9 8 7 6 5 4 3 2 1

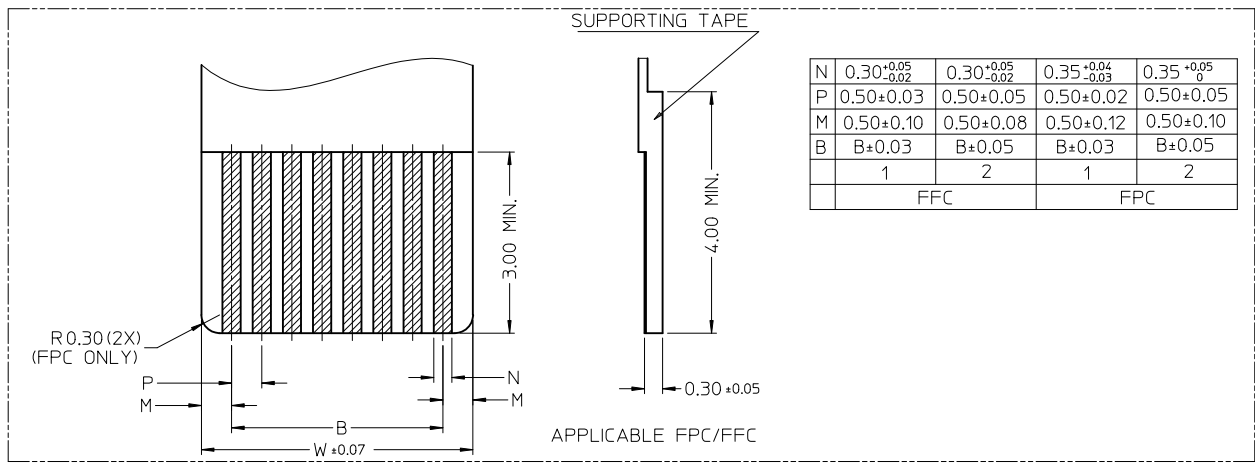
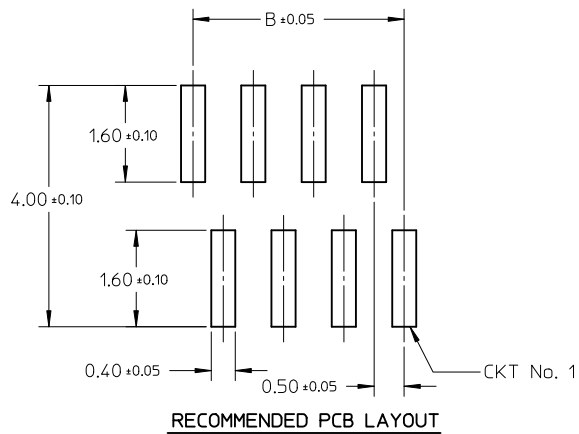



N	0.30 <sup>+0.05</sup> <sub>-0.02</sub>	0.30 <sup>+0.05</sup> <sub>-0.02</sub>	0.35 <sup>+0.04</sup> <sub>-0.03</sub>	0.35 <sup>+0.05</sup> <sub>0</sub>
P	0.50±0.03	0.50±0.05	0.50±0.02	0.50±0.05
M	0.50±0.10	0.50±0.08	0.50±0.12	0.50±0.10
B	B±0.03	B±0.05	B±0.03	B±0.05
	1	2	1	2
	FFC		FPC	

REVISED EC NO: J2012-1253 DRWN: KMIYAHARA 2012/03/23 CHYKD: KTAHASHI 2012/03/26 APPR: KMORIKAWA 2012/03/30	QUALITY SYMBOLS	GENERAL TOLERANCES (UNLESS SPECIFIED)		DIMENSION STYLE	SCALE	DESIGN UNITS	THIRD ANGLE PROJECTION	
	▽=0 ◻=0	mm	INCH	MM ONLY	NTS	METRIC		
		4 PLACES ± ---	± ---	DRAWN BY	DATE	TITLE		
		3 PLACES ± ---	± ---	YLO1A0	2006/04/11	0.50MM PITCH, FPC CONN. NON-ZIF, SMT		
	2 PLACES ± 0.15	± ---	CHECKED BY	DATE	MOLEX INCORPORATED			
	1 PLACE ± ---	± ---	BOKOK	2006/04/18	DOCUMENT NO.		SHEET NO.	
	ANGULAR ± 3 °		APPROVED BY	DATE	SD-78119-001		2 OF 7	
			PTLIM	2006/04/18	SEE TABLE			
			MATERIAL NO.		THIS DRAWING CONTAINS INFORMATION THAT IS PROPRIETARY TO MOLEX INCORPORATED AND SHOULD NOT BE USED WITHOUT WRITTEN PERMISSION			

GOLD PLATING TERMINAL ASSEMBLY PART NUMBERS

ASSY P/N W/O PACKAGING	CKT	DIM A	DIM B	DIM C	DIM D	PLATING TYPE
78119-0108	10	7.10	4.50	6.40	5.60	1
78119-0118	11	7.60	5.00	6.90	6.10	
78119-0128	12	8.10	5.50	7.40	6.60	
78119-0138	13	8.60	6.00	7.90	7.10	
78119-0148	14	9.10	6.50	8.40	7.60	
78119-0158	15	9.60	7.00	8.90	8.10	
78119-0168	16	10.10	7.50	9.40	8.60	
78119-0178	17	10.60	8.00	9.90	9.10	
78119-0188	18	11.10	8.50	10.40	9.60	
78119-0198	19	11.60	9.00	10.90	10.10	
78119-0208	20	12.10	9.50	11.40	10.60	
78119-0218	21	12.60	10.00	11.90	11.10	
78119-0228	22	13.10	10.50	12.40	11.60	
78119-0238	23	13.60	11.00	12.90	12.10	
78119-0248	24	14.10	11.50	13.40	12.60	
78119-0258	25	14.60	12.00	13.90	13.10	
78119-0268	26	15.10	12.50	14.40	13.60	
78119-0278	27	15.60	13.00	14.90	14.10	
78119-0288	28	16.10	13.50	15.40	14.60	
78119-0298	29	16.60	14.00	15.90	15.10	
78119-0308	30	17.10	14.50	16.40	15.60	

ASSY P/N W/O PACKAGING	CKT	DIM A	DIM B	DIM C	DIM D	PLATING TYPE
78119-0318	31	17.60	15.00	16.90	16.10	1
78119-0328	32	18.10	15.50	17.40	16.60	
78119-0338	33	18.60	16.00	17.90	17.10	
78119-0348	34	19.10	16.50	18.40	17.60	
78119-0358	35	19.60	17.00	18.90	18.10	
78119-0368	36	20.10	17.50	19.40	18.60	
78119-0378	37	20.60	18.00	19.90	19.10	
78119-0388	38	21.10	18.50	20.40	19.60	
78119-0398	39	21.60	19.00	20.90	20.10	
78119-0408	40	22.10	19.50	21.40	20.60	

REVISED IEC NO: J2012-1253 DRW: KMIYAHARA 2012/03/23 CHK: KDKTAKAHASHI 2012/03/26 APPR: KMORIKAWA 2012/03/30	QUALITY SYMBOLS	GENERAL TOLERANCES (UNLESS SPECIFIED)		DIMENSION STYLE MM ONLY		SCALE NTS	DESIGN UNITS METRIC	THIRD ANGLE PROJECTION		
	 = 0  = 0	4 PLACES ± --- ± --- 3 PLACES ± --- ± --- 2 PLACES ± 0.15 ± --- 1 PLACE ± --- ± --- ANGULAR ± 3 °	mm INCH DRAWN BY YLQIAO DATE 2006/04/11 CHECKED BY BOKOK DATE 2006/04/18 APPROVED BY PTLIM DATE 2006/04/18	TITLE 0.50MM PITCH, FPC CONN. NON-ZIF, SMT		MATERIAL NO. SEE TABLE		DOCUMENT NO. SD-78119-001		SHEET NO. 3 OF 7
	DRAFT WHERE APPLICABLE MUST REMAIN WITHIN DIMENSIONS	THIS DRAWING CONTAINS INFORMATION THAT IS PROPRIETARY TO MOLEX INCORPORATED AND SHOULD NOT BE USED WITHOUT WRITTEN PERMISSION		MOLEX MOLEX INCORPORATED						
	SIZE A3									

TIN-BISMUTH PLATING TERMINAL ASSEMBLY PART NUMBERS

ASSY P/N W/O PACKAGING	CKT	DIM A	DIM B	DIM C	DIM D	PLATING TYPE
78119-0109	10	7.10	4.50	6.40	5.60	2
78119-0119	11	7.60	5.00	6.90	6.10	
78119-0129	12	8.10	5.50	7.40	6.60	
78119-0139	13	8.60	6.00	7.90	7.10	
78119-0149	14	9.10	6.50	8.40	7.60	
78119-0159	15	9.60	7.00	8.90	8.10	
78119-0169	16	10.10	7.50	9.40	8.60	
78119-0179	17	10.60	8.00	9.90	9.10	
78119-0189	18	11.10	8.50	10.40	9.60	
78119-0199	19	11.60	9.00	10.90	10.10	
78119-0209	20	12.10	9.50	11.40	10.60	
78119-0219	21	12.60	10.00	11.90	11.10	
78119-0229	22	13.10	10.50	12.40	11.60	
78119-0239	23	13.60	11.00	12.90	12.10	
78119-0249	24	14.10	11.50	13.40	12.60	
78119-0259	25	14.60	12.00	13.90	13.10	
78119-0269	26	15.10	12.50	14.40	13.60	
78119-0279	27	15.60	13.00	14.90	14.10	
78119-0289	28	16.10	13.50	15.40	14.60	
78119-0299	29	16.60	14.00	15.90	15.10	
78119-0309	30	17.10	14.50	16.40	15.60	

ASSY P/N W/O PACKAGING	CKT	DIM A	DIM B	DIM C	DIM D	PLATING TYPE
78119-0319	31	17.60	15.00	16.90	16.10	2
78119-0329	32	18.10	15.50	17.40	16.60	
78119-0339	33	18.60	16.00	17.90	17.10	
78119-0349	34	19.10	16.50	18.40	17.60	
78119-0359	35	19.60	17.00	18.90	18.10	
78119-0369	36	20.10	17.50	19.40	18.60	
78119-0379	37	20.60	18.00	19.90	19.10	
78119-0389	38	21.10	18.50	20.40	19.60	
78119-0399	39	21.60	19.00	20.90	20.10	
78119-0409	40	22.10	19.50	21.40	20.60	

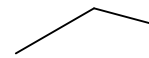

REVISED IEC NO: J2012-1253 DRW: KMIYAHARA 2012/03/23 CHK: KDKTAKAHASHI 2012/03/26 APPR: KMORI KAWA 2012/03/30	QUALITY SYMBOLS	GENERAL TOLERANCES (UNLESS SPECIFIED)	DIMENSION STYLE	SCALE	DESIGN UNITS	THIRD ANGLE PROJECTION	
	▼ = 0 ▽ = 0	mm    INCH 4 PLACES ± --- ± --- 3 PLACES ± --- ± --- 2 PLACES ± 0.15 ± --- 1 PLACE ± --- ± --- ANGULAR ± 3 °	MM ONLY	NTS	METRIC	☉ □	
	DRAWN BY: YLQIAO    DATE: 2006/04/11 CHECKED BY: BOKOK    DATE: 2006/04/18 APPROVED BY: PTLIM    DATE: 2006/04/18	DRAFT WHERE APPLICABLE MUST REMAIN WITHIN DIMENSIONS		TITLE: 0.50MM PITCH, FPC CONN. NON-ZIF, SMT		MOLEX INCORPORATED	
	MATERIAL NO. SEE TABLE SIZE: A3	THIS DRAWING CONTAINS INFORMATION THAT IS PROPRIETARY TO MOLEX INCORPORATED AND SHOULD NOT BE USED WITHOUT WRITTEN PERMISSION		DOCUMENT NO. SD-78119-001	SHEET NO. 4 OF 7		

EMBOSSSED TYPE A

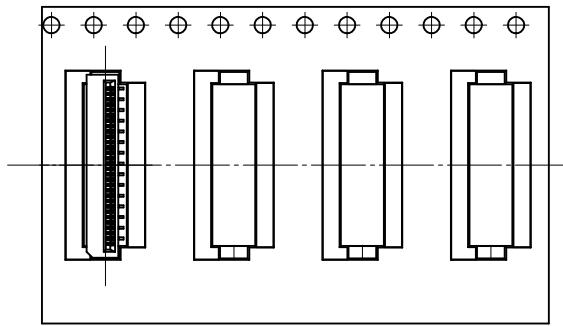

CUSTOMER  
PULL OUT DIRECTION

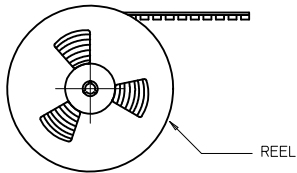

REEL

NOTES:

1. LEADER AND TRAILER TAPE

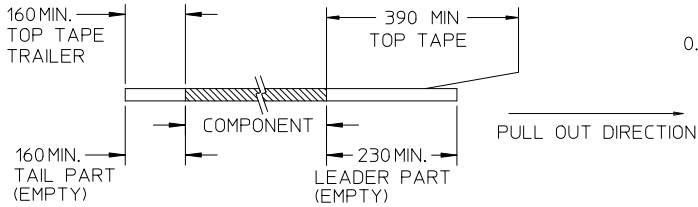

2. PEELING OFF FORCE OF THE TOP TAPE: 20-80gf.  
(PEELING DIRECTION AS SHOWN IN FOLLOWING FIGURE)

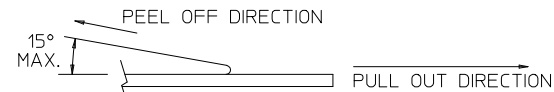

- 3. PACKAGING STANDARD IS AS PER EIA-481.
- 4. TAPE & REEL QUANTITY = 1000 PCS/REEL

EMBOSSSED TYPE B

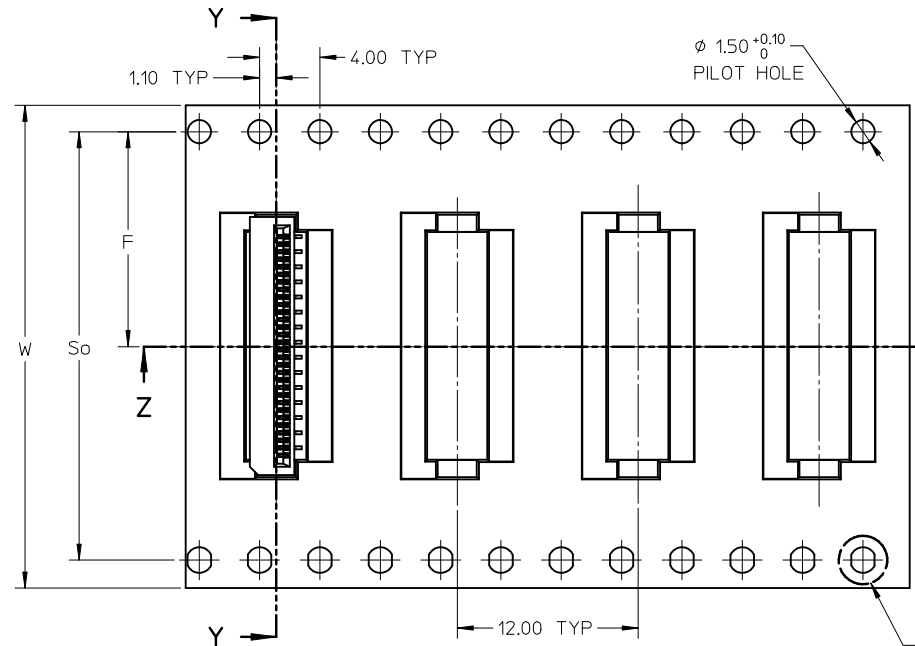

DETAIL 1

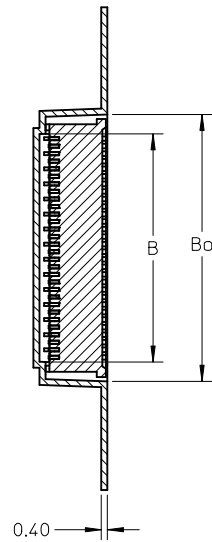

SECTION Y-Y

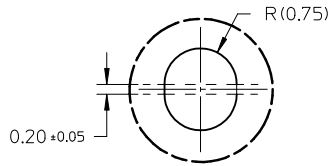

DETAIL 1

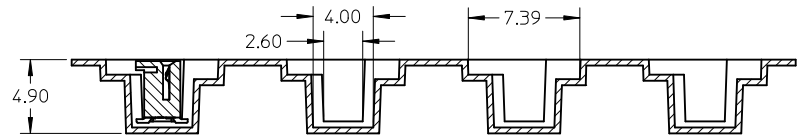

SECTION Z-Z

REVISED EC NO: J2012-1253 DR: NIKKI YAHARA 2012/03/23 CHKD: K TAKAHASHI 2012/03/26 APPR: K MORIKAWA 2012/03/30	QUALITY SYMBOLS ▽=0 ◻=0	GENERAL TOLERANCES (UNLESS SPECIFIED)		DIMENSION STYLE MM ONLY	SCALE NTS	DESIGN UNITS METRIC	THIRD ANGLE PROJECTION
			mm	INCH	DRAWN BY YLOIAO	DATE 2006/04/11	TITLE 0.50MM PITCH, FPC CONN. NON-ZIF, SMT
		4 PLACES	± ---	± ---	CHECKED BY BOKOK	DATE 2006/04/18	MOLEX INCORPORATED
		3 PLACES	± ---	± ---	APPROVED BY PTLIM	DATE 2006/04/18	
			ANGULAR ± 3 °		MATERIAL NO. SEE TABLE	DOCUMENT NO. SD-78119-001	SHEET NO. 5 OF 7
A3	REV	DRAFT WHERE APPLICABLE MUST REMAIN WITHIN DIMENSIONS		SIZE A3	THIS DRAWING CONTAINS INFORMATION THAT IS PROPRIETARY TO MOLEX INCORPORATED AND SHOULD NOT BE USED WITHOUT WRITTEN PERMISSION		

GOLD PLATING TERMINAL ASSEMBLY PART NUMBERS

ASSY P/N PACKED IN T&R	ASSY P/N W/O PACKAGING	CKT	W	So	F	Bo	B	EMBOSSED TYPE
78119-1108	78119-0108	10	24.00	-	11.50	7.40	5.10	A
78119-1118	78119-0118	11	24.00	-	11.50	7.90	5.60	
78119-1128	78119-0128	12	24.00	-	11.50	8.40	6.10	
78119-1138	78119-0138	13	24.00	-	11.50	8.90	6.60	
78119-1148	78119-0148	14	24.00	-	11.50	9.40	7.10	
78119-1158	78119-0158	15	24.00	-	11.50	9.90	7.60	
78119-1168	78119-0168	16	24.00	-	11.50	10.40	8.10	
78119-1178	78119-0178	17	24.00	-	11.50	10.90	8.60	
78119-1188	78119-0188	18	24.00	-	11.50	11.40	9.10	
78119-1198	78119-0198	19	24.00	-	11.50	11.90	9.60	
78119-1208	78119-0208	20	24.00	-	11.50	12.40	10.10	
78119-1218	78119-0218	21	32.00	28.40	14.20	12.90	10.60	B
78119-1228	78119-0228	22	32.00	28.40	14.20	13.40	11.10	
78119-1238	78119-0238	23	32.00	28.40	14.20	13.90	11.60	
78119-1248	78119-0248	24	32.00	28.40	14.20	14.40	12.10	
78119-1258	78119-0258	25	32.00	28.40	14.20	14.90	12.60	
78119-1268	78119-0268	26	32.00	28.40	14.20	15.40	13.10	
78119-1278	78119-0278	27	32.00	28.40	14.20	15.90	13.60	
78119-1288	78119-0288	28	32.00	28.40	14.20	16.40	14.10	
78119-1298	78119-0298	29	32.00	28.40	14.20	16.90	14.60	
78119-1308	78119-0308	30	32.00	28.40	14.20	17.40	15.10	

ASSY P/N PACKED IN T&R	ASSY P/N W/O PACKAGING	CKT	W	So	F	Bo	B	EMBOSSED TYPE
78119-1318	78119-0318	31	32.00	28.40	14.20	17.90	15.60	B
78119-1328	78119-0328	32	32.00	28.40	14.20	18.40	16.10	
78119-1338	78119-0338	33	32.00	28.40	14.20	18.90	16.60	
78119-1348	78119-0348	34	32.00	28.40	14.20	19.40	17.10	
78119-1358	78119-0358	35	32.00	28.40	14.20	19.90	17.60	
78119-1368	78119-0368	36	32.00	28.40	14.20	20.40	18.10	
78119-1378	78119-0378	37	32.00	28.40	14.20	20.90	18.60	
78119-1388	78119-0388	38	32.00	28.40	14.20	21.40	19.10	
78119-1398	78119-0398	39	44.00	40.40	20.20	21.90	19.60	
78119-1408	78119-0408	40	44.00	40.40	20.20	22.40	20.10	

REVISED EC NO: J2012-1253 DRWN: KMIYAHARA 2012/03/23 CHKD: KTAHASHI 2012/03/26 APPR: KMORIKAWA 2012/03/30	QUALITY SYMBOLS = 0 = 0	GENERAL TOLERANCES (UNLESS SPECIFIED)		DIMENSION STYLE MM ONLY		SCALE NTS	DESIGN UNITS METRIC	THIRD ANGLE PROJECTION		
		4 PLACES ± --- ± ---	mm INCH	DRAWN BY YLQ1A0	DATE 2006/04/11	TITLE 0.50MM PITCH, FPC CONN. NON-ZIF, SMT				
		3 PLACES ± --- ± ---		CHECKED BY BOKOK	DATE 2006/04/18					
		2 PLACES ± 0.15 ± ---		APPROVED BY PTL IM	DATE 2006/04/18	MOLEX INCORPORATED				
1 PLACE ± --- ± ---		ANGULAR ± 3 °		MATERIAL NO. SEE TABLE	DOCUMENT NO. SD-78119-001	SHEET NO. 6 OF 7				
DRAFT WHERE APPLICABLE MUST REMAIN WITHIN DIMENSIONS		THIS DRAWING CONTAINS INFORMATION THAT IS PROPRIETARY TO MOLEX INCORPORATED AND SHOULD NOT BE USED WITHOUT WRITTEN PERMISSION								

TIN-BISMUTH PLATING TERMINAL ASSEMBLY PART NUMBERS

ASSY P/N PACKED IN T&R	ASSY P/N W/O PACKAGING	CKT	W	So	F	Bo	B	EMBOSSED TYPE
78119-1109	78119-0109	10	24.00	-	11.50	7.40	5.10	A
78119-1119	78119-0119	11	24.00	-	11.50	7.90	5.60	
78119-1129	78119-0129	12	24.00	-	11.50	8.40	6.10	
78119-1139	78119-0139	13	24.00	-	11.50	8.90	6.60	
78119-1149	78119-0149	14	24.00	-	11.50	9.40	7.10	
78119-1159	78119-0159	15	24.00	-	11.50	9.90	7.60	
78119-1169	78119-0169	16	24.00	-	11.50	10.40	8.10	
78119-1179	78119-0179	17	24.00	-	11.50	10.90	8.60	
78119-1189	78119-0189	18	24.00	-	11.50	11.40	9.10	
78119-1199	78119-0199	19	24.00	-	11.50	11.90	9.60	
78119-1209	78119-0209	20	24.00		11.50	12.40	10.10	
78119-1219	78119-0219	21	32.00	28.40	14.20	12.90	10.60	
78119-1229	78119-0229	22	32.00	28.40	14.20	13.40	11.10	
78119-1239	78119-0239	23	32.00	28.40	14.20	13.90	11.60	
78119-1249	78119-0249	24	32.00	28.40	14.20	14.40	12.10	
78119-1259	78119-0259	25	32.00	28.40	14.20	14.90	12.60	
78119-1269	78119-0269	26	32.00	28.40	14.20	15.40	13.10	
78119-1279	78119-0279	27	32.00	28.40	14.20	15.90	13.60	
78119-1289	78119-0289	28	32.00	28.40	14.20	16.40	14.10	
78119-1299	78119-0299	29	32.00	28.40	14.20	16.90	14.60	
78119-1309	78119-0309	30	32.00	28.40	14.20	17.40	15.10	

ASSY P/N PACKED IN T&R	ASSY P/N W/O PACKAGING	CKT	W	So	F	Bo	B	EMBOSSED TYPE
78119-1319	78119-0319	31	32.00	28.40	14.20	17.90	15.60	
78119-1329	78119-0329	32	32.00	28.40	14.20	18.40	16.10	
78119-1339	78119-0339	33	32.00	28.40	14.20	18.90	16.60	
78119-1349	78119-0349	34	32.00	28.40	14.20	19.40	17.10	
78119-1359	78119-0359	35	32.00	28.40	14.20	19.90	17.60	
78119-1369	78119-0369	36	32.00	28.40	14.20	20.40	18.10	
78119-1379	78119-0379	37	32.00	28.40	14.20	20.90	18.60	
78119-1389	78119-0389	38	32.00	28.40	14.20	21.40	19.10	
78119-1399	78119-0399	39	44.00	40.40	20.20	21.90	19.60	
78119-1409	78119-0409	40	44.00	40.40	20.20	22.40	20.10	

REVISED EC NO: J2012-1253 DRW:KMI YAHARA 2012/03/23 CHKD:KTAHASHI 2012/03/26 APPR:KMORIKAWA 2012/03/30	QUALITY SYMBOLS	GENERAL TOLERANCES (UNLESS SPECIFIED)	DIMENSION STYLE	SCALE	DESIGN UNITS	THIRD ANGLE PROJECTION
	▽=0 C=0	mm INCH 4 PLACES ± --- ± --- 3 PLACES ± --- ± --- 2 PLACES ± 0.15 ± --- 1 PLACE ± --- ± --- ANGULAR ± 3 °	MM ONLY	NTS	METRIC	
	DESCRIPTION	DRAFT WHERE APPLICABLE MUST REMAIN WITHIN DIMENSIONS	DRAWN BY DATE YLQIAO 2006/04/11 CHECKED BY DATE BOKOK 2006/04/18 APPROVED BY DATE PTLIM 2006/04/18 MATERIAL NO.	TITLE 0.50MM PITCH, FPC CONN. NON-ZIF, SMT	MOLEX INCORPORATED DOCUMENT NO. SD-78119-001	
	REV	SIZE A3	THIS DRAWING CONTAINS INFORMATION THAT IS PROPRIETARY TO MOLEX INCORPORATED AND SHOULD NOT BE USED WITHOUT WRITTEN PERMISSION	SHEET NO. 7 OF 7		