



# Ultra-Small, Low-Cost, 85MHz Op Amps with Rail-to-Rail Outputs and Disable

## General Description

The MAX4389/MAX4390/MAX4392–MAX4396 family of op amps are unity-gain stable devices that combine high-speed performance, rail-to-rail outputs, and disable mode. These devices are targeted for applications where an input or an output is exposed to the outside world, such as video and communications.

The MAX4389/MAX4390/MAX4392–MAX4396 operate from a single 4.5V to 11V supply or from dual  $\pm 2.25V$  to  $\pm 5.5V$  supplies. The common-mode input voltage range extends to the negative power-supply rail (ground in single-supply applications). The MAX4389/MAX4390/MAX4392–MAX4396 consume only 5.5mA of quiescent supply current per amplifier while achieving a 85MHz -3dB bandwidth, 27MHz 0.1dB gain flatness, and a 500V/ $\mu s$  slew rate. Disable mode sets the outputs to high impedance while consuming only 450 $\mu A$  of current.

The MAX4389 single, MAX4393 dual, MAX4394 triple, and MAX4396 quad include disable capabilities. The MAX4389 and MAX4390 are available in ultra-small, 6-pin SC70 packages.

## Applications

Set-Top Boxes  
Surveillance Video Systems  
Analog-to-Digital Converter Interface  
CCD Imaging Systems  
Digital Cameras  
Video-on-Demand  
Video Line Driver

## Typical Operating Circuit

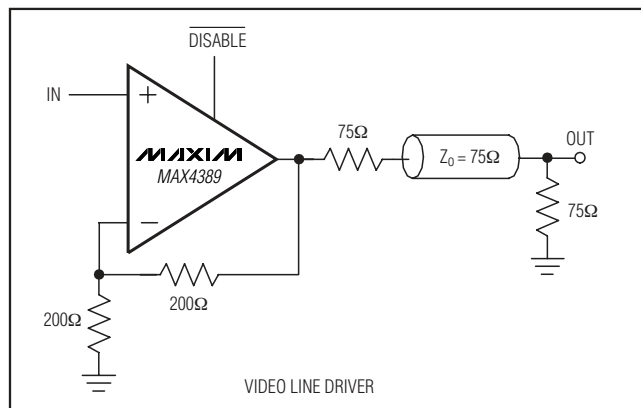

## Features

- ◆ Low Cost
- ◆ High Speed
  - 85MHz -3dB Bandwidth
  - 27MHz 0.1dB Gain Flatness
  - 500V/ $\mu s$  Slew Rate
- ◆ Single 4.5V to 11V or Dual  $\pm 2.25V$  to  $\pm 5.5V$  Operation
- ◆ Rail-to-Rail Outputs
- ◆ Input Common-Mode Range Extends to  $V_{EE}$
- ◆ Low Differential Gain/Phase: 0.015%/0.015°
- ◆ Low Distortion at 5MHz
  - 59dBc Spurious-Free Dynamic Range
- ◆ High Output Drive:  $\pm 50mA$
- ◆ 450 $\mu A$  Disable Capability (MAX4389/MAX4393/MAX4394/MAX4396)
- ◆ Space-Saving SC70, SOT23,  $\mu MAX$ , or TSSOP Packages

## Ordering Information

PART	TEMP RANGE	PIN-PACKAGE	TOP MARK
MAX4389EXT+T	-40°C to +85°C	6 SC70	ABF
MAX4389EUT+T	-40°C to +85°C	6 SOT23	ABDC
MAX4389EUT/V+T	-40°C to +85°C	6 SOT23	ABDC
MAX4390EXT+T	-40°C to +85°C	6 SC70	ABE
MAX4390EUK+T	-40°C to +85°C	5 SOT23	ADZM

Ordering Information continued at end of data sheet.

Selector Guide appears at end of data sheet.

+ Denotes a lead(Pb)-free/RoHs-compliant package.

/V denotes an automotive qualified part.

T = Tape and reel.

## Pin Configurations

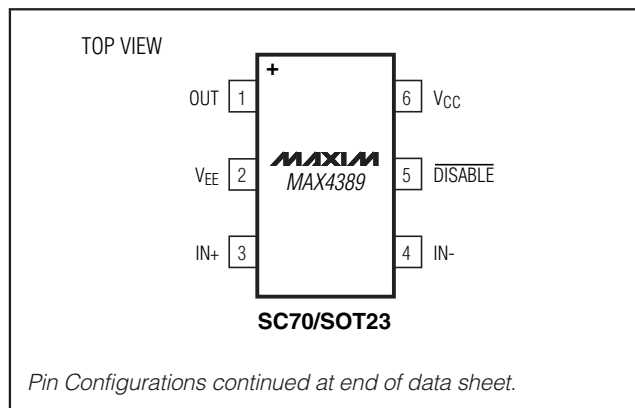

# Ultra-Small, Low-Cost, 85MHz Op Amps with Rail-to-Rail Outputs and Disable

## ABSOLUTE MAXIMUM RATINGS

Supply Voltage ( $V_{CC}$ to $V_{EE}$ )	-0.3V to +12V	8-Pin SO (derate 5.88mW/°C above +70°C)	471mW
$IN_+$ , $IN_-$ , $OUT_-$ , $DISABLE_-$	( $V_{EE} - 0.3V$ ) to ( $V_{CC} + 0.3V$ )	8-Pin $\mu$ MAX (derate 4.5mW/°C above +70°C)	362mW
Differential Input Voltage	$\pm 2.5V$	10-Pin $\mu$ MAX (derate 5.6mW/°C above +70°C)	444mW
Current into Input Pins	$\pm 20mA$	14-Pin SO (derate 8.33mW/°C above +70°C)	667mW
Output Short-Circuit Duration to $V_{CC}$ or $V_{EE}$ (Note 1)	Continuous	14-Pin TSSOP (derate 10mW/°C above +70°C)	727mW
Continuous Power Dissipation ( $T_A = +70^\circ C$ )		20-Pin TSSOP (derate 10.9mW/°C above +70°C)	879mW
5-Pin SOT23 (derate 7.1mW/°C above +70°C)	571mW	Operating Temperature Range	-40°C to +85°C
6-Pin SOT23 (derate 8.7mW/°C above +70°C)	696mW	Junction Temperature	+150°C
6-Pin SC70 (derate 3.1mW/°C above +70°C)	245mW	Storage Temperature Range	-65°C to +150°C
		Lead Temperature (soldering, 10s)	+300°C

**Note 1:** Continuous power dissipation must also be observed.

Stresses beyond those listed under "Absolute Maximum Ratings" may cause permanent damage to the device. These are stress ratings only, and functional operation of the device at these or any other conditions beyond those indicated in the operational sections of the specifications is not implied. Exposure to absolute maximum rating conditions for extended periods may affect device reliability.

## DC ELECTRICAL CHARACTERISTICS—Single Supply

( $V_{CC} = 5V$ ,  $V_{EE} = 0V$ ,  $V_{CM} = V_{CC}/2$ ,  $V_{OUT} = V_{CC}/2$ ,  $R_L = \infty$  to  $V_{CC}/2$ ,  $DISABLE_- = V_{CC}$  (MAX4389/MAX4393/MAX4394/MAX4396),  $T_A = T_{MIN}$  to  $T_{MAX}$ , unless otherwise noted. Typical values are at  $T_A = +25^\circ C$ .) (Note 2)

PARAMETER	SYMBOL	CONDITIONS	MIN	TYP	MAX	UNITS
Input Common-Mode Voltage Range	$V_{CM}$	Guaranteed by CMRR test	$V_{EE} - 0.2$		$V_{CC} - 2.25$	V
Input Offset Voltage	$V_{OS}$	$T_A = +25^\circ C$		5	18	mV
		$T_A = -40^\circ C$ to $+85^\circ C$			26	
Input Offset Voltage Matching		MAX4392–MAX4396		1		mV
Input Offset Voltage Tempco	$TC_{VOS}$			15		$\mu V/^\circ C$
Input Bias Current	$I_B$			2.5	15	$\mu A$
Input Offset Current	$I_{OS}$			0.2	5	$\mu A$
Input Resistance	$R_{IN}$	Differential mode ( $-1V \leq V_{IN} \leq +1V$ )		70		k $\Omega$
		Common mode ( $-0.2V \leq V_{CM} \leq +2.75V$ )		3		M $\Omega$
Common-Mode Rejection Ratio	CMRR	$(V_{EE} - 0.2V) \leq V_{CM} \leq (V_{CC} - 2.25V)$	70	95		dB
Open-Loop Gain	$A_{VOL}$	$0.25V \leq V_{OUT} \leq 4.75V$ , $R_L = 2k\Omega$	50	70		dB
		$0.8V \leq V_{OUT} \leq 4.5V$ , $R_L = 150\Omega$	50	60		
		$1V \leq V_{OUT} \leq 4V$ , $R_L = 50\Omega$		58		
Output Voltage Swing	$V_{OUT}$	$R_L = 2k\Omega$	$V_{CC} - V_{OH}$	0.065	0.25	V
			$V_{OL} - V_{EE}$	0.05	0.15	
		$R_L = 150\Omega$	$V_{CC} - V_{OH}$	0.3	0.5	
			$V_{OL} - V_{EE}$	0.25	0.5	
		$R_L = 75\Omega$	$V_{CC} - V_{OH}$	0.5	0.8	
			$V_{OL} - V_{EE}$	0.45	0.8	
		$R_L = 75\Omega$ to ground	$V_{CC} - V_{OH}$	1	1.7	
			$V_{OL} - V_{EE}$	0.025	0.1	
Output Current	$I_{OUT}$	Sinking from $R_L = 75\Omega$ to $V_{CC}$	40	55	mA	
		Sourcing into $R_L = 75\Omega$ to $V_{EE}$	40	50		
Output Short-Circuit Current	$I_{SC}$	Sinking or sourcing		$\pm 100$		mA
Open-Loop Output Resistance	$R_{OUT}$			8		$\Omega$

# Ultra-Small, Low-Cost, 85MHz Op Amps with Rail-to-Rail Outputs and Disable

MAX4389/MAX4390/MAX4392-MAX4396

## DC ELECTRICAL CHARACTERISTICS—Single Supply (continued)

( $V_{CC} = 5V$ ,  $V_{EE} = 0V$ ,  $V_{CM} = V_{CC}/2$ ,  $V_{OUT} = V_{CC}/2$ ,  $R_L = \infty$  to  $V_{CC}/2$ ,  $\overline{DISABLE} = V_{CC}$  (MAX4389/MAX4393/MAX4394/MAX4396),  $T_A = T_{MIN}$  to  $T_{MAX}$ , unless otherwise noted. Typical values are at  $T_A = +25^\circ C$ .) (Note 2)

PARAMETER	SYMBOL	CONDITIONS	MIN	TYP	MAX	UNITS
Power-Supply Rejection Ratio	PSRR	$V_{EE} = 0V$ , $V_{CC} = 4.5V$ to $5.5V$	48	65		dB
Operating Supply Voltage Range	$V_S$	Guaranteed by PSRR	4.5		11	V
Disabled Output Resistance	$R_{OUT(OFF)}$	$\overline{DISABLE} = 0$ , $0 \leq V_{OUT} \leq 5V$	40	95		k $\Omega$
$\overline{DISABLE}$ Logic-Low Threshold	$V_{IL}$				$V_{CC} - 3$	V
$\overline{DISABLE}$ Logic-High Threshold	$V_{IH}$		$V_{CC} - 1.25$			V
$\overline{DISABLE}$ Logic Input Low Current	$I_{IL}$	$\overline{DISABLE} = 0$		20	60	$\mu A$
$\overline{DISABLE}$ Logic Input High Current	$I_{IH}$	$\overline{DISABLE} = V_{CC}$		5	40	$\mu A$
Quiescent Supply Current (Per Amplifier)	$I_S$	$\overline{DISABLE} = V_{CC}$		3.2	5	mA
		$\overline{DISABLE} = 0$		0.3	0.4	

## DC ELECTRICAL CHARACTERISTICS—Dual Supply

( $V_{CC} = 5V$ ,  $V_{EE} = -5V$ ,  $V_{CM} = 0V$ ,  $V_{OUT} = 0V$ ,  $R_L = \infty$  to 0,  $\overline{DISABLE} = V_{CC}$  (MAX4389/MAX4393/MAX4394/MAX4396),  $T_A = T_{MIN}$  to  $T_{MAX}$ , unless otherwise noted. Typical values are at  $T_A = +25^\circ C$ .) (Note 2)

PARAMETER	SYMBOL	CONDITIONS	MIN	TYP	MAX	UNITS
Input Common-Mode Voltage	$V_{CM}$	Guaranteed by CMRR test	$V_{EE}$		$V_{CC} - 2.25$	V
Input Offset Voltage	$V_{OS}$	$T_A = +25^\circ C$		7	20	mV
		$T_A = -40^\circ C$ to $+85^\circ C$			28	
Input Offset Voltage Matching		MAX4392-MAX4396		1		mV
Input Offset Voltage Tempco	$TC_{VOS}$			20		$\mu V/^\circ C$
Input Bias Current	$I_B$			5	15	$\mu A$
Input Offset Current	$I_{OS}$			0.5	5	$\mu A$
Input Resistance	$R_{IN}$	Differential mode ( $-1V \leq V_{IN} \leq +1V$ )		70		k $\Omega$
		Common mode ( $-0.2V \leq V_{CM} \leq +2.75V$ )		3		M $\Omega$
Common-Mode Rejection Ratio	CMRR	$V_{EE} \leq V_{CM} \leq (V_{CC} - 2.25V)$	70	90		dB
Open-Loop Gain	$A_{VOL}$	$-4.5V \leq V_{OUT} \leq 4.5V$ , $R_L = 2k\Omega$	65	80		dB
		$-4.25V \leq V_{OUT} \leq 4.25V$ , $R_L = 150\Omega$	50	60		

# Ultra-Small, Low-Cost, 85MHz Op Amps with Rail-to-Rail Outputs and Disable

## DC ELECTRICAL CHARACTERISTICS—Dual Supply (continued)

( $V_{CC} = 5V$ ,  $V_{EE} = -5V$ ,  $V_{CM} = 0V$ ,  $V_{OUT} = 0V$ ,  $R_L = \infty$  to  $0$ ,  $\overline{DISABLE}_- = V_{CC}$  (MAX4389/MAX4393/MAX4394/MAX4396),  $T_A = T_{MIN}$  to  $T_{MAX}$ , unless otherwise noted. Typical values are at  $T_A = +25^\circ C$ .) (Note 2)

PARAMETER	SYMBOL	CONDITIONS	MIN	TYP	MAX	UNITS
Output Voltage Swing	$V_{OUT}$	$R_L = 2k\Omega$	$V_{CC} - V_{OH}$	0.175	0.3	V
			$V_{OL} - V_{EE}$	0.075	0.2	
		$R_L = 150\Omega$	$V_{CC} - V_{OH}$	0.575	0.85	
			$V_{OL} - V_{EE}$	0.4	1.5	
		$R_L = 75\Omega$	$V_{CC} - V_{OH}$	1.5	2.35	
			$V_{OL} - V_{EE}$	0.75	1.6	
Output Current	$I_{OUT}$	Sinking from $R_L = 75\Omega$ to $V_{CC}$	50	95	mA	
		Sourcing into $R_L = 75\Omega$ to $V_{EE}$	50	75		
Output Short-Circuit Current	$I_{SC}$	Sinking or sourcing	$\pm 100$			mA
Open-Loop Output Resistance	$R_{OUT}$		8			$\Omega$
Power-Supply Rejection Ratio	PSRR	$V_{EE} = 0V$ , $V_{CC} = 4.5V$ to $5.5V$	48	60		dB
Operating Supply Voltage Range	$V_S$	Guaranteed by PSRR	4.5		11	V
Disabled Output Resistance	$R_{OUT(OFF)}$	$\overline{DISABLE}_- = 0V$ , $-5V \leq V_{OUT} \leq +5V$	40	95		$k\Omega$
$\overline{DISABLE}_-$ Logic-Low Threshold	$V_{IL}$		$V_{CC} - 3$			V
$\overline{DISABLE}_-$ Logic-High Threshold	$V_{IH}$		$V_{CC} - 1.25$			V
Quiescent Supply Current (Per Amplifier)	$I_S$	$\overline{DISABLE}_- = V_{CC}$	6		10	mA
		$\overline{DISABLE}_- = 0V$	0.45		0.8	

## AC ELECTRICAL CHARACTERISTICS—Single Supply

( $V_{CC} = 5V$ ,  $V_{EE} = 0V$ ,  $V_{CM} = 1.5V$ ,  $R_L = 100\Omega$  to  $V_{CC}/2$ ,  $\overline{DISABLE}_- = V_{CC}$  (MAX4389/MAX4393/MAX4394/MAX4396),  $V_{OUT} = V_{CC}/2$ ,  $A_{VCL} = 1V/V$ ,  $T_A = +25^\circ C$ , unless otherwise noted.)

PARAMETER	SYMBOL	CONDITIONS	MIN	TYP	MAX	UNITS
Small-Signal -3dB Bandwidth	$BW_{SS}$	$V_{OUT} = 100mV_{P-P}$		72		MHz
Large-Signal -3dB Bandwidth	$BW_{LS}$	$V_{OUT} = 2V_{P-P}$		80		MHz
Small-Signal 0.1dB Gain Flatness	$BW_{0.1dBSS}$	$V_{OUT} = 100mV_{P-P}$		30		MHz
Large-Signal 0.1dB Gain Flatness	$BW_{0.1dBLS}$	$V_{OUT} = 2V_{P-P}$		30		MHz
Slew Rate	SR	$V_{OUT} = 2V$ step		500		$V/\mu s$
Settling Time to 0.1%	$t_s$	$V_{OUT} = 2V$ step		28		ns
Rise/Fall Time	$t_R/t_F$	$V_{OUT} = 100mV_{P-P}$		4		ns
Spurious-Free Dynamic Range	SFDR	$f_C = 5MHz$ , $V_{OUT} = 2V_{P-P}$		-59		dBc

# Ultra-Small, Low-Cost, 85MHz Op Amps with Rail-to-Rail Outputs and Disable

MAX4389/MAX4390/MAX4392-MAX4396

## AC ELECTRICAL CHARACTERISTICS—Single Supply (continued)

( $V_{CC} = 5V$ ,  $V_{EE} = 0V$ ,  $V_{CM} = 1.5V$ ,  $R_L = 100\Omega$  to  $V_{CC}/2$ ,  $\overline{DISABLE} = V_{CC}$  (MAX4389/MAX4393/MAX4394/MAX4396),  $V_{OUT} = V_{CC}/2$ ,  $A_{VCL} = 1V/V$ ,  $T_A = +25^\circ C$ , unless otherwise noted.)

PARAMETER	SYMBOL	CONDITIONS	MIN	TYP	MAX	UNITS
Differential Phase Error	DP	NTSC, $R_L = 150\Omega$		0.015		degrees
Differential Gain Error	DG	NTSC, $R_L = 150\Omega$		0.015		%
Input Noise-Voltage Density	$e_n$	$f = 10kHz$		13		nV/ $\sqrt{Hz}$
Input Noise-Current Density	$i_n$	$f = 10kHz$		2.1		pA/ $\sqrt{Hz}$
Input Capacitance	$C_{IN}$			1		pF
Output Impedance	$Z_{OUT}$	$f = 5MHz$		0.6		$\Omega$
Disable OFF Time		MAX4389/MAX4393/MAX4394/MAX4396		80		ns
Disable ON Time		MAX4389/MAX4393/MAX4394/MAX4396		40		ns
Channel-to-Channel Isolation	$CH_{ISO}$	MAX4392-MAX4396, specified at DC		-97		dB

## AC ELECTRICAL CHARACTERISTICS—Dual Supply

( $V_{CC} = 5V$ ,  $V_{EE} = -5V$ ,  $R_L = \infty$  to GND,  $GND = 0$ ,  $V_{OUT} = 0V$ ,  $Gain = 1V/V$ ,  $\overline{DISABLE} = V_{CC}$ , and  $T_A = T_{MIN}$  to  $T_{MAX}$ , unless otherwise noted. Typical values are at  $T_A = +25^\circ C$ .)

PARAMETER	SYMBOL	CONDITIONS	MIN	TYP	MAX	UNITS
Small-Signal -3dB Bandwidth	$BW_{SS}$	$V_{OUT} = 100mV_{P-P}$		85		MHz
Large-Signal -3dB Bandwidth	$BW_{LS}$	$V_{OUT} = 2V_{P-P}$		90		MHz
Small-Signal Bandwidth for 0.1dB Gain Flatness	$BW_{0.1dBSS}$	$V_{OUT} = 100mV_{P-P}$		27		MHz
Large-Signal Bandwidth for 0.1dB Gain Flatness	$BW_{0.1dBLS}$	$V_{OUT} = 2V_{P-P}$		24		MHz
Slew Rate	SR	$V_{OUT} = 2V$ step		500		V/ $\mu s$
Settling Time to 0.1%	$t_S$	$V_{OUT} = 2V$ step		21		ns
Rise/Fall Time	$t_R/t_F$	$V_{OUT} = 100mV_{P-P}$		4		ns
Spurious-Free Dynamic Range	SFDR	$f_C = 5MHz$ , $V_{OUT} = 2V_{P-P}$		-59		dBc
Differential Phase Error	DP	NTSC, $R_L = 150\Omega$		0.015		degrees
Differential Gain Error	DG	NTSC, $R_L = 150\Omega$		0.015		%
Input Noise-Voltage Density	$e_n$	$f = 10kHz$		13		nV/ $\sqrt{Hz}$
Input Noise-Current Density	$i_n$	$f = 10kHz$		2.1		pA/ $\sqrt{Hz}$
Input Capacitance	$C_{IN}$			1		pF
Output Impedance	$Z_{OUT}$	$f = 5MHz$		0.6		$\Omega$
Disable OFF Time		MAX4389/MAX4393/MAX4394/MAX4396		80		ns
Disable ON Time		MAX4389/MAX4393/MAX4394/MAX4396		40		ns
Channel-to-Channel Isolation	$CH_{ISO}$	MAX4392/MAX4393/MAX4394/MAX4395/ MAX4396, specified at DC		-97		dB

**Note 2:** All devices are 100% production tested at  $T_A = +25^\circ C$ . Specifications over temperature limits are guaranteed by design.

# Ultra-Small, Low-Cost, 85MHz Op Amps with Rail-to-Rail Outputs and Disable

## Typical Operating Characteristics

( $V_{CC} = 5V$ ,  $V_{EE} = -5V$ ,  $V_{CM} = 0V$ ,  $A_{VCL} = 1V/V$ ,  $R_L = 100\Omega$  to GND, GND = 0,  $T_A = +25^\circ C$ , unless otherwise noted.)

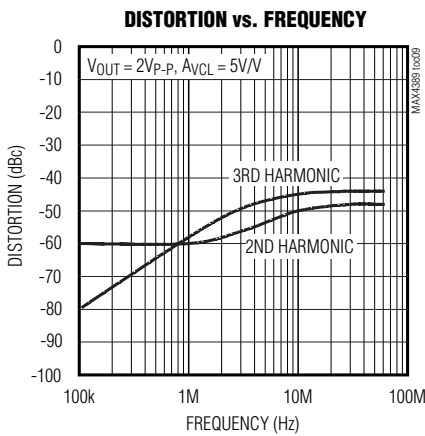
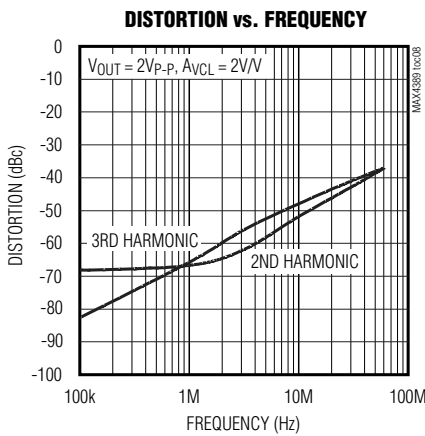
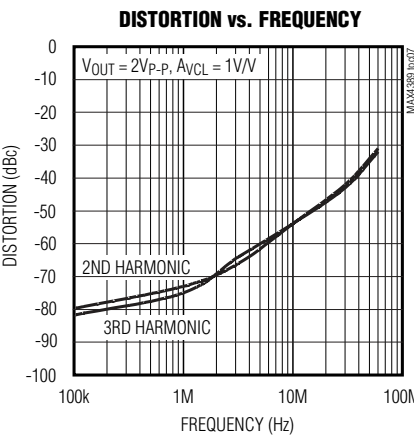
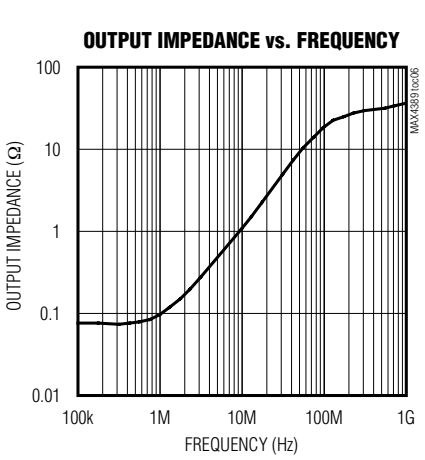
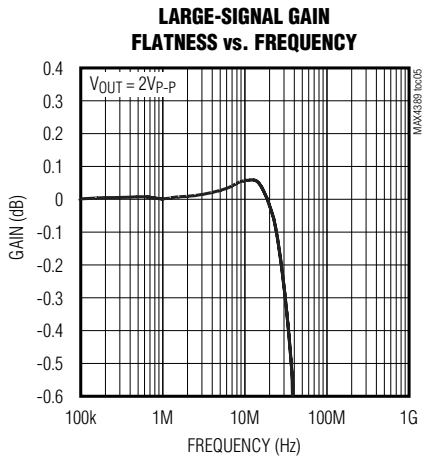
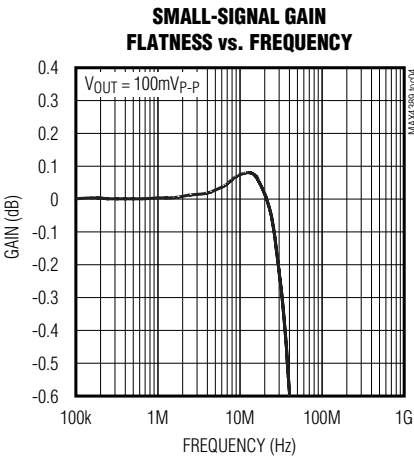
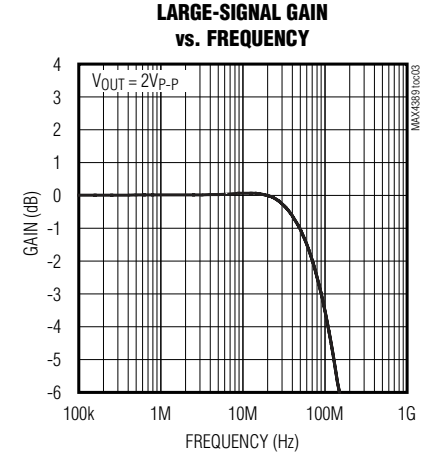
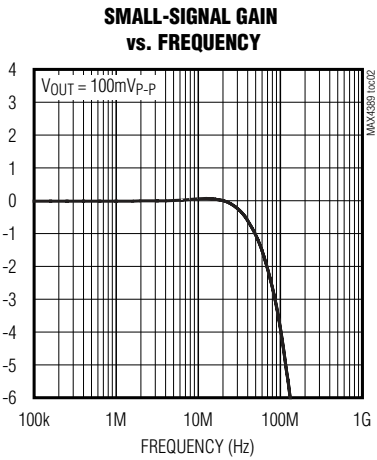
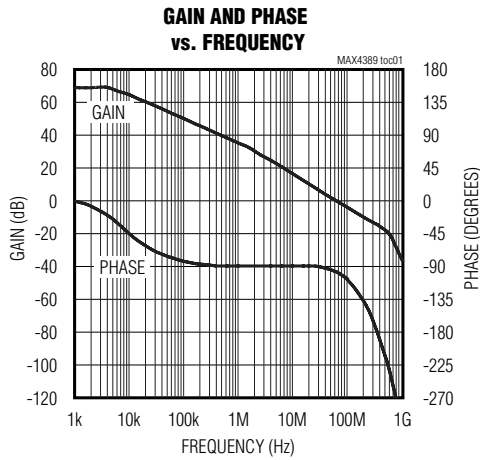

# Ultra-Small, Low-Cost, 85MHz Op Amps with Rail-to-Rail Outputs and Disable

## Typical Operating Characteristics (continued)

( $V_{CC} = 5V$ ,  $V_{EE} = -5V$ ,  $V_{CM} = 0V$ ,  $A_{VCL} = 1V/V$ ,  $R_L = 100\Omega$  to GND,  $GND = 0$ ,  $T_A = +25^\circ C$ , unless otherwise noted.)

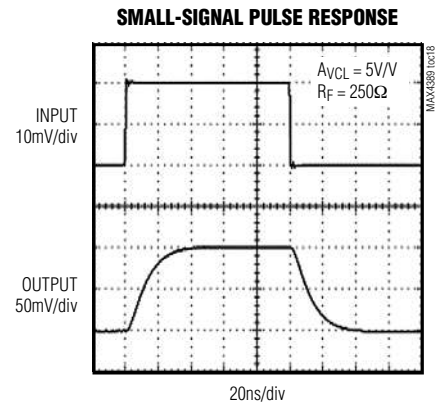
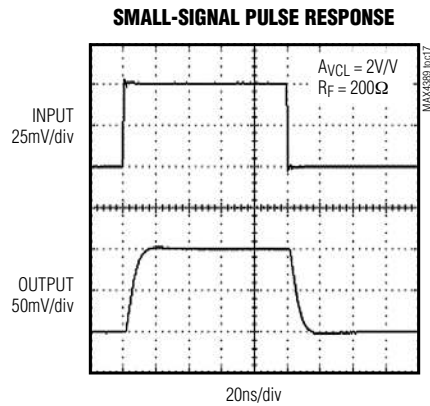
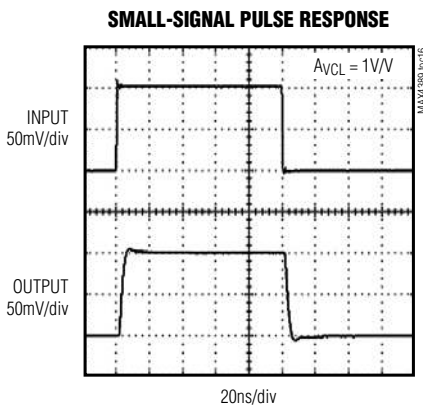
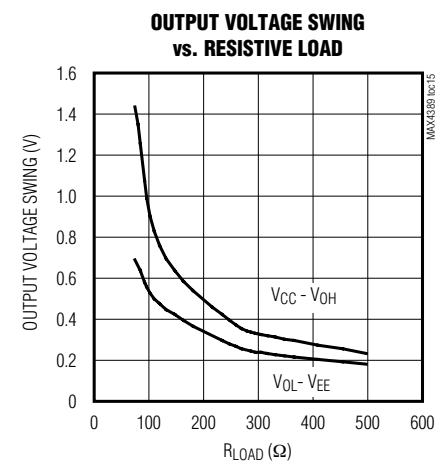
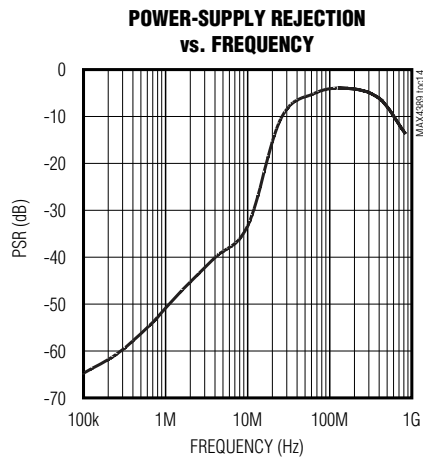
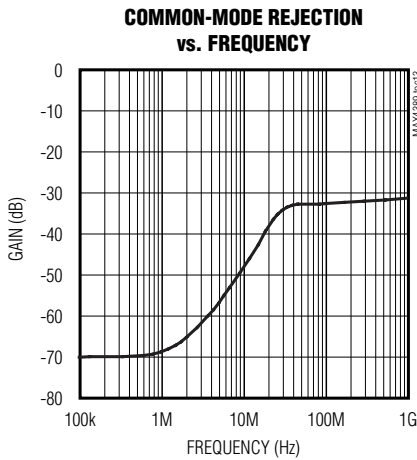
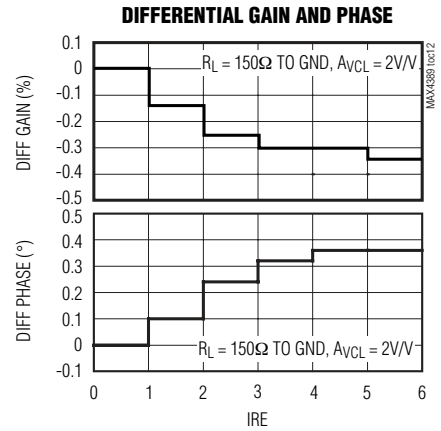
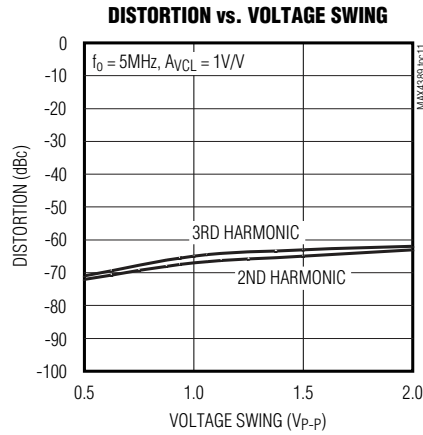
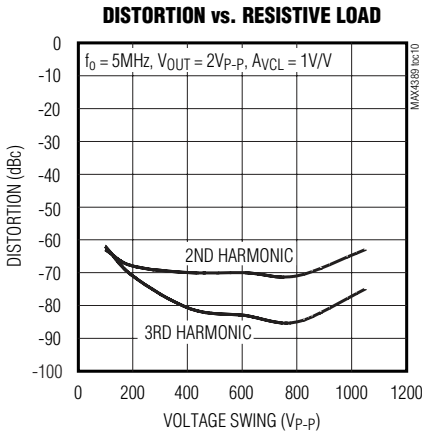

# Ultra-Small, Low-Cost, 85MHz Op Amps with Rail-to-Rail Outputs and Disable

## Typical Operating Characteristics (continued)

( $V_{CC} = 5V$ ,  $V_{EE} = -5V$ ,  $V_{CM} = 0V$ ,  $A_{VCL} = 1V/V$ ,  $R_L = 100\Omega$  to GND,  $GND = 0$ ,  $T_A = +25^\circ C$ , unless otherwise noted.)

**LARGE-SIGNAL PULSE RESPONSE**

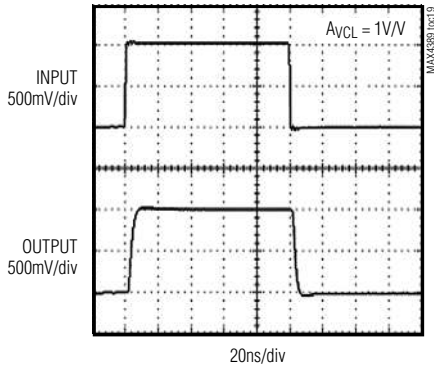

**LARGE-SIGNAL PULSE RESPONSE**

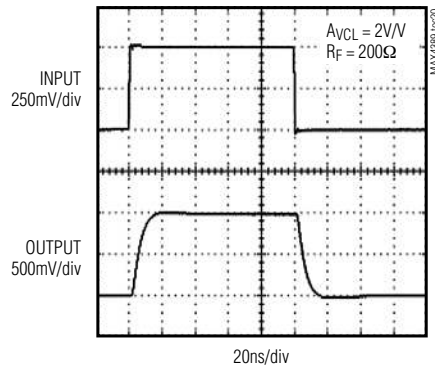

**LARGE-SIGNAL PULSE RESPONSE**

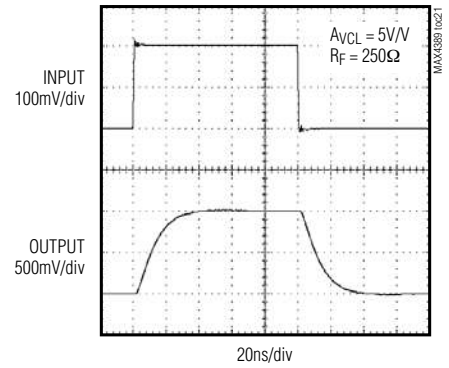

**VOLTAGE NOISE vs. FREQUENCY**

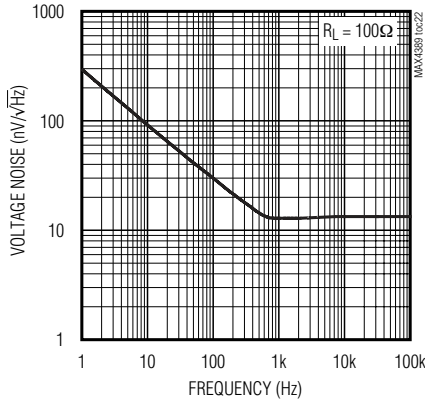

**CURRENT NOISE vs. FREQUENCY**

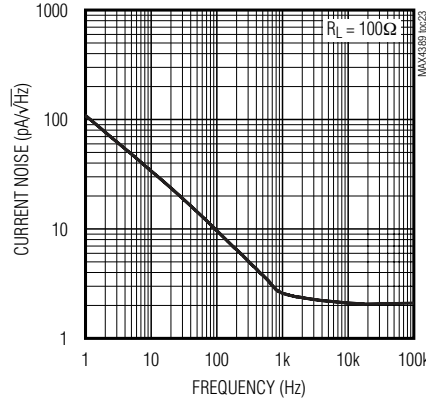

**ISOLATION RESISTANCE vs. CAPACITIVE LOAD**

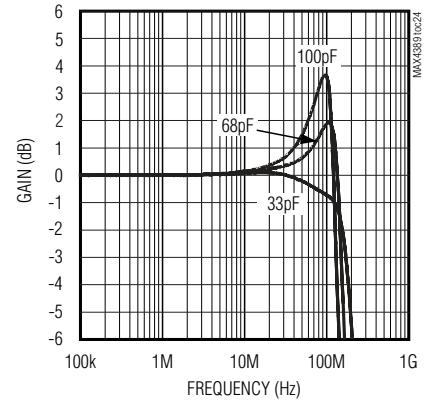



# Ultra-Small, Low-Cost, 85MHz Op Amps with Rail-to-Rail Outputs and Disable

## Typical Operating Characteristics (continued)

( $V_{CC} = 5V$ ,  $V_{EE} = -5V$ ,  $V_{CM} = 0V$ ,  $A_{VCL} = 1V/V$ ,  $R_L = 100\Omega$  to GND,  $GND = 0$ ,  $T_A = +25^\circ C$ , unless otherwise noted.)

**SMALL-SIGNAL BANDWIDTH vs. LOAD RESISTANCE**

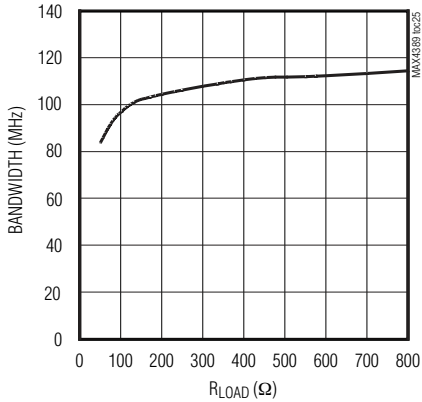

**OPEN-LOOP GAIN vs. RESISTIVE LOAD**

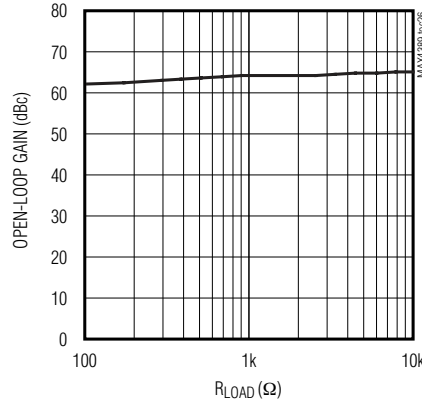

**CROSSTALK vs. FREQUENCY**

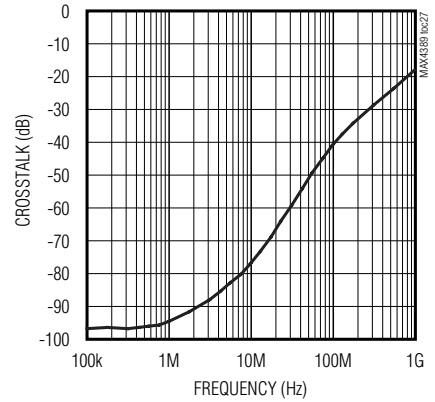

**DISABLE RESPONSE**

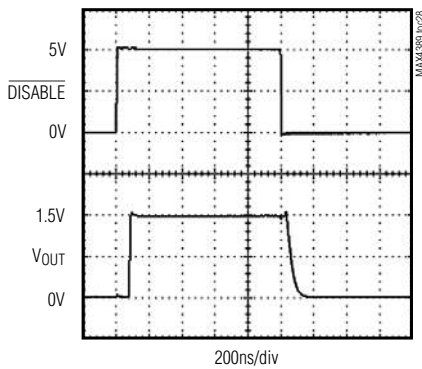

**INPUT OFFSET VOLTAGE vs. TEMPERATURE**

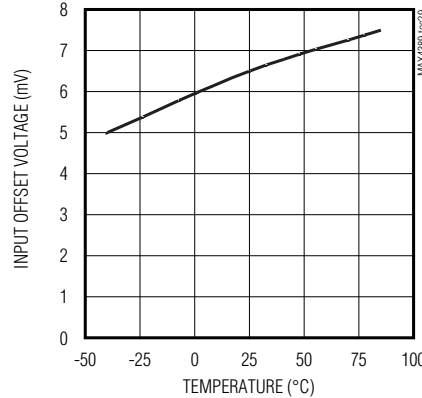

**INPUT BIAS CURRENT vs. TEMPERATURE**

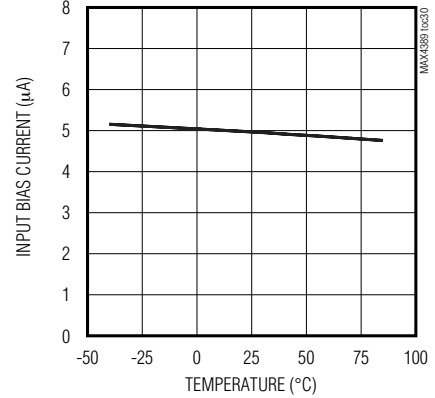

**SUPPLY CURRENT vs. TEMPERATURE**

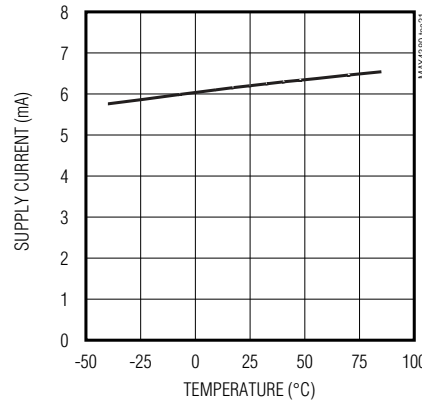

MAX4389/MAX4390/MAX4392-MAX4396

# Ultra-Small, Low-Cost, 85MHz Op Amps with Rail-to-Rail Outputs and Disable

## Pin Description

PIN								NAME	FUNCTION
MAX4389	MAX4390		MAX4392	MAX4393	MAX4394	MAX4395	MAX4396		
SC70/SOT23	SC70	SOT23	μMAX/SO	μMAX	SO/TSSOP	SO/TSSOP	TSSOP		
1	1	1	—	—	—	—	—	OUT	Amplifier Output
2	2	2	4	4	11	11	16	VEE	Negative Power Supply. Connect a 0.1μF Capacitor to GND.
3	3	3	—	—	—	—	—	IN+	Noninverting Input
4	4	4	—	—	—	—	—	IN-	Inverting Input
5	—	—	—	—	—	—	—	DISABLE	Disable. Connect to VCC to Enable.
6	6	5	8	10	4	4	5	VCC	Positive Power Supply. Connect a 0.1μF Capacitor to GND.
—	5	—	—	—	—	—	10, 11	N.C.	No Connection. Not Internally Connected.
—	—	—	3	3	5	3	4	INA+	Amplifier A Noninverting Input
—	—	—	2	2	6	2	3	INA-	Amplifier A Inverting Input
—	—	—	1	1	7	1	2	OUTA	Amplifier A Output
—	—	—	—	5	1	—	1	DISABLEA	Shutdown Amplifier A. Connect to VCC to Enable.
—	—	—	5	7	10	5	6	INB+	Amplifier B Noninverting Input
—	—	—	6	8	9	6	7	INB-	Amplifier B Inverting Input
—	—	—	7	9	8	7	8	OUTB	Amplifier B Output

# Ultra-Small, Low-Cost, 85MHz Op Amps with Rail-to-Rail Outputs and Disable

## Pin Description (continued)

PIN								NAME	FUNCTION
MAX4389	MAX4390		MAX4392	MAX4393	MAX4394	MAX4395	MAX4396		
SC70/SOT23	SC70	SOT23	μMAX/SO	μMAX	SO/TSSOP	SO/TSSOP	TSSOP		
—	—	—	—	6	3	—	9	$\overline{\text{DISABLEB}}$	Shutdown Amplifier B. Connect to V <sub>CC</sub> to Enable.
—	—	—	—	—	12	10	15	INC+	Amplifier C Noninverting Input
—	—	—	—	—	13	9	14	INC-	Amplifier C Inverting Input
—	—	—	—	—	14	8	13	OUTC	Amplifier C Output
—	—	—	—	—	2	—	12	$\overline{\text{DISABLEC}}$	Shutdown Amplifier C. Connect to V <sub>CC</sub> to Enable.
—	—	—	—	—	—	12	17	IND+	Amplifier D Noninverting Input
—	—	—	—	—	—	13	18	IND-	Amplifier D Inverting Input
—	—	—	—	—	—	14	19	OUTD	Amplifier D Output
—	—	—	—	—	—	—	20	$\overline{\text{DISABLED}}$	Shutdown Amplifier D. Connect to V <sub>CC</sub> to Enable.

MAX4389/MAX4390/MAX4392-MAX4396

### Detailed Description

The MAX4389/MAX4390/MAX4392-MAX4396 are dual-supply, rail-to-rail, voltage-feedback amplifiers that employ current-feedback techniques to achieve 500V/μs slew rates and 85MHz bandwidths. Excellent harmonic distortion and differential gain/phase performance make these amplifiers an ideal choice for a wide variety of video and RF signal-processing applications.

### Applications Information

The output voltage swings to within 200mV of each supply rail. Local feedback around the output stage ensures low open-loop output impedance to reduce

gain sensitivity to load variations. The input stage permits common-mode voltages to the negative supply and to within 2.25V of the positive supply rail.

### Choosing Resistor Values

#### Unity-Gain Configuration

The MAX4389/MAX4390/MAX4392-MAX4396 are internally compensated for unity gain. When configured for unity gain, a 24Ω resistor (R<sub>F</sub>) in series with the feedback path optimizes AC performance. This resistor improves AC response by reducing the Q of the parallel LC circuit formed by the parasitic feedback capacitance and inductance.

# Ultra-Small, Low-Cost, 85MHz Op Amps with Rail-to-Rail Outputs and Disable

## Video Line Driver

The MAX4389/MAX4390/MAX4392-MAX4396 are low-power, voltage-feedback amplifiers featuring large-signal (2V<sub>P-P</sub>) bandwidths of 90MHz and 0.1dB large-signal gain flatness of 24MHz. They are designed to minimize differential-gain error and differential-phase error to 0.015% and 0.015°, respectively. They have a 21ns settling time to 0.1%, 500V/μs slew rates, and output-current-drive capability of up to 50mA making them ideal for driving video loads.

## Inverting and Noninverting Configurations

Select the gain-setting feedback ( $R_F$ ) and input ( $R_G$ ) resistor values to fit your application. Large resistor values increase voltage noise and interact with the amplifier's input and PC board capacitance. This can generate undesirable poles and zeros and decrease bandwidth or cause oscillations. For example, a noninverting gain-of-two configuration ( $R_F = R_G$ ) using 2kΩ resistors, combined with 1pF of amplifier input capacitance and 1pF of PC board capacitance, causes a pole at 79.6MHz. Since this pole is within the amplifier bandwidth, it jeopardizes stability. Reducing the 2kΩ resistors to 100Ω extends the pole frequency to 1.59GHz, but could limit output swing by adding 200Ω in parallel with the amplifier's load resistor (Figures 1a and 1b).

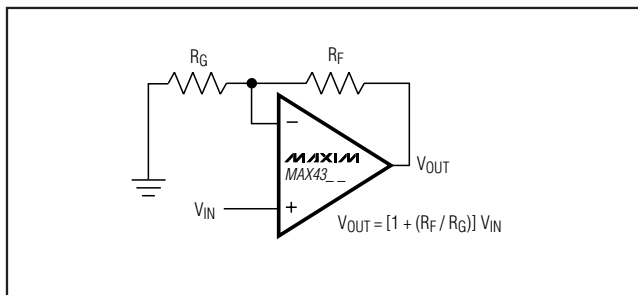

Figure 1a. Noninverting Gain Configuration

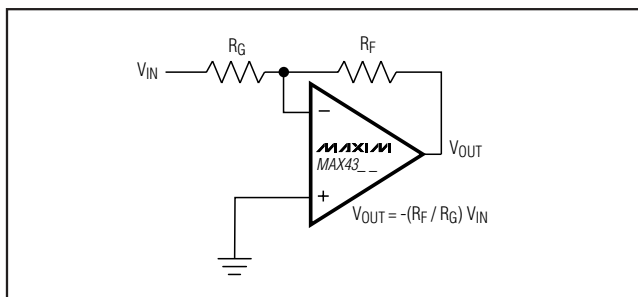

Figure 1b. Inverting Gain Configuration

## Layout and Power-Supply Bypassing

The MAX4389/MAX4390/MAX4392-MAX4396 operate from single 4.5V to 11V or from dual  $\pm 2.25V$  to  $\pm 5.5V$  supplies. Bypass each supply with a 0.1μF capacitor as close to the pin as possible.

Maxim recommends using microstrip and stripline techniques to obtain full bandwidth. To ensure that the PC board does not degrade the amplifier's performance, design it for a frequency greater than 1GHz. Pay careful attention to inputs and outputs to avoid large parasitic capacitance. Whether or not you use a constant-impedance board, observe the following design guidelines:

- Do not use wire-wrap boards; they are too inductive.
- Do not use IC sockets; they increase parasitic capacitance and inductance.
- Use surface-mount instead of through-hole components for better, high-frequency performance.
- Use a PC board with at least two layers; it should be as free from voids as possible.
- Keep signal lines as short and as straight as possible. Do not make 90° turns; round all corners.

## Low-Power Disable Mode

The MAX4389/MAX4393/MAX4394/MAX4396 feature a disable function that allows the amplifiers to be placed in a low-power, high-output-impedance state. When the disable pin ( $\overline{\text{DISABLE}}$ ) is active, the amplifier's output impedance is 95kΩ. This high resistance and the low 2pF output capacitance make the MAX4389/MAX4390/MAX4392-MAX4396 in RF/video multiplexer or switch applications. For larger arrays, pay careful attention to capacitive loading (see the *Output Capacitive Loading and Stability* section).

## Output Capacitive Loading and Stability

The MAX4389/MAX4390/MAX4392-MAX4396 are optimized for AC performance. They are not designed to drive highly reactive loads, which decrease phase margin and may produce excessive ringing and oscillation. Figure 2 shows a circuit that eliminates this problem. Figure 3 is a graph of the Optimal Isolation Resistor ( $R_S$ ) vs. Capacitive Load. Figure 4 shows how a capacitive load causes excessive peaking of the amplifier's frequency response if the capacitor is not isolated from the amplifier by a resistor. A small isolation resistor (usually 10Ω to 15Ω) placed before the reactive load prevents ringing and oscillation. At higher capacitive loads, AC performance is controlled by the interaction of the load capacitance and the isolation resistor. Figure 5 shows the effect of a 15Ω isolation resistor on closed-loop response.

# Ultra-Small, Low-Cost, 85MHz Op Amps with Rail-to-Rail Outputs and Disable

MAX4389/MAX4390/MAX4392-MAX4396

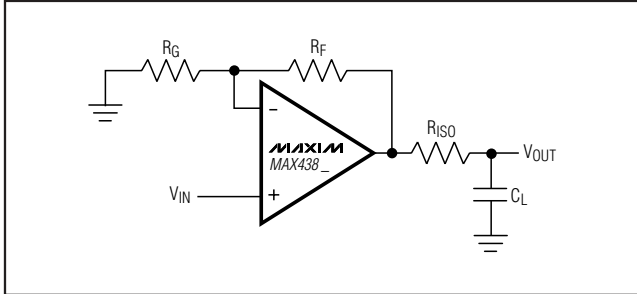

Figure 2. Driving a Capacitive Load Through an Isolation Resistor

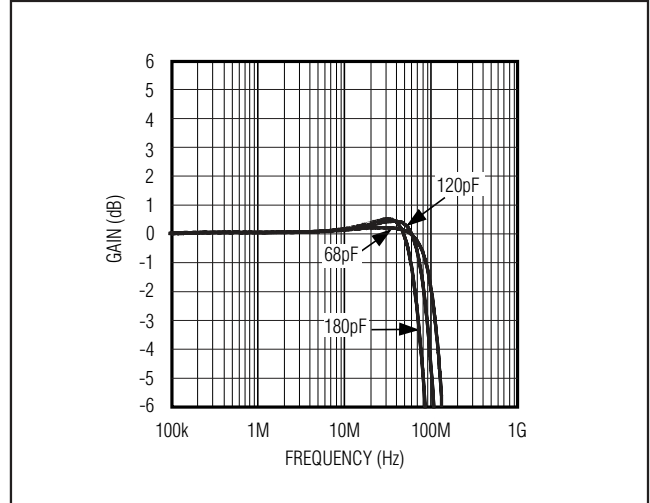

Figure 5. Small-Signal Gain vs. Frequency with Load Capacitance and 27Ω Isolation Resistor

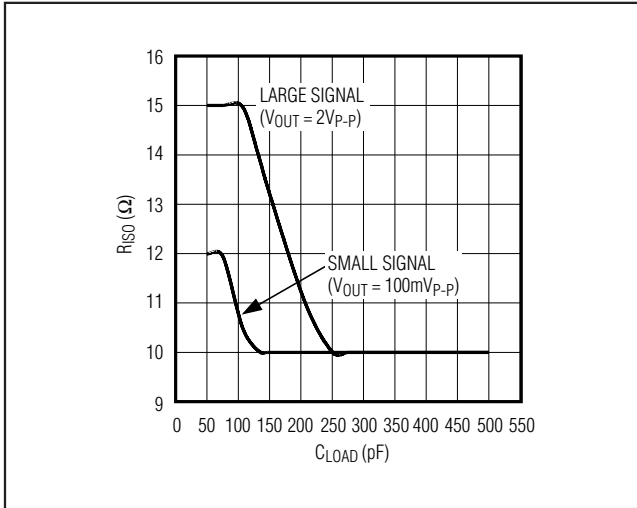

Figure 3. Isolation Resistance vs. Capacitive Load

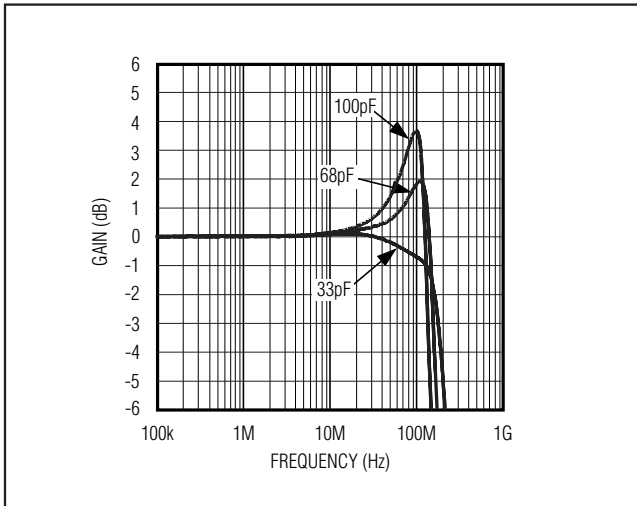

Figure 4. Small-Signal Gain vs. Frequency with Load Capacitance and No Isolation Resistor

## Chip Information

- MAX4389 TRANSISTOR COUNT: 70
- MAX4390 TRANSISTOR COUNT: 70
- MAX4392 TRANSISTOR COUNT: 204
- MAX4393 TRANSISTOR COUNT: 204
- MAX4394 TRANSISTOR COUNT: 298
- MAX4395 TRANSISTOR COUNT: 396
- MAX4396 TRANSISTOR COUNT: 396
- PROCESS: BiCMOS

# Ultra-Small, Low-Cost, 85MHz Op Amps with Rail-to-Rail Outputs and Disable

## Pin Configurations (continued)

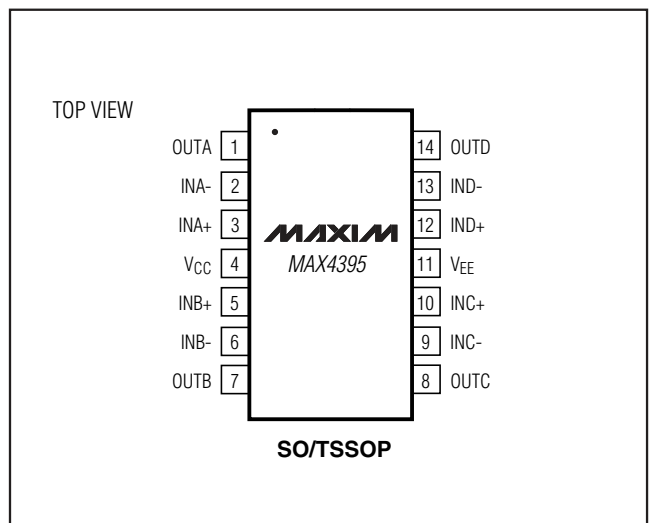
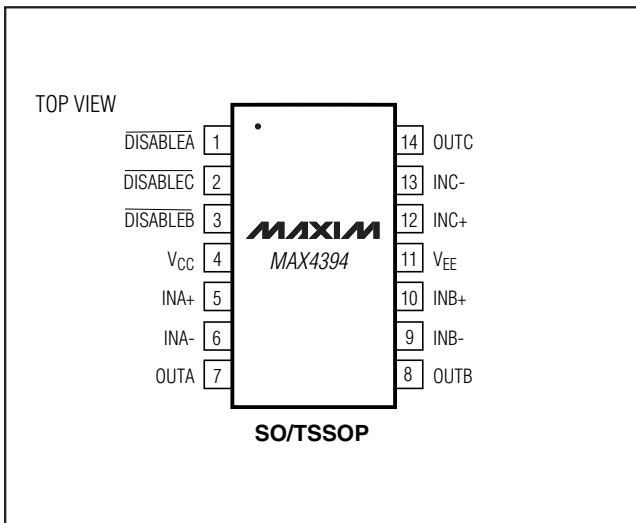
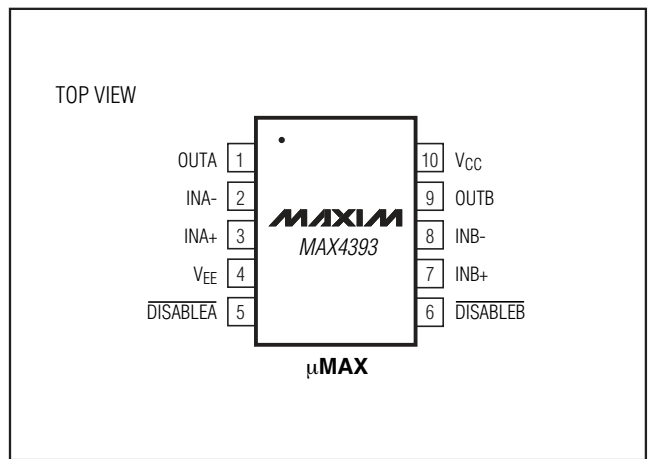
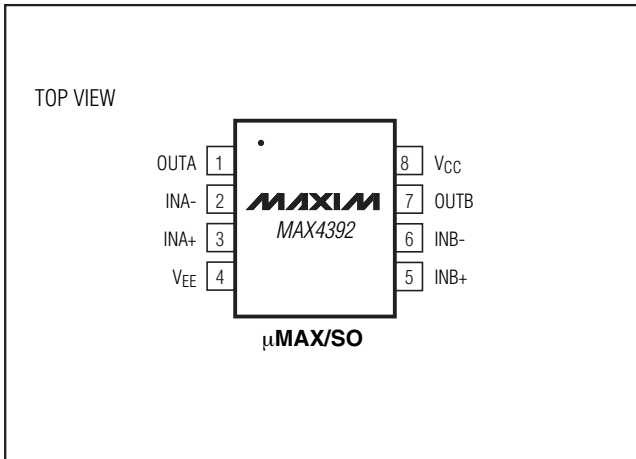
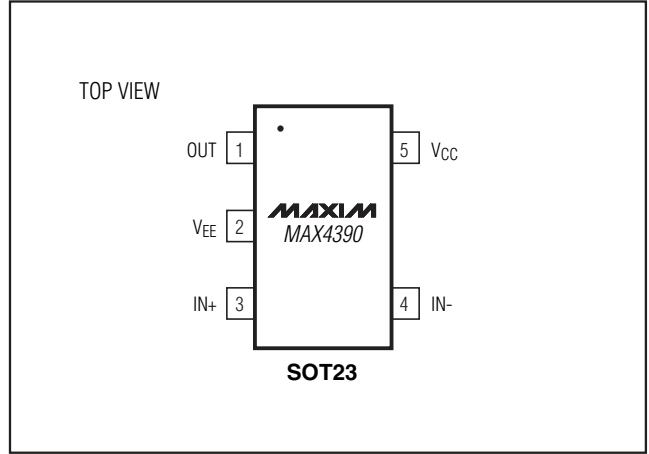
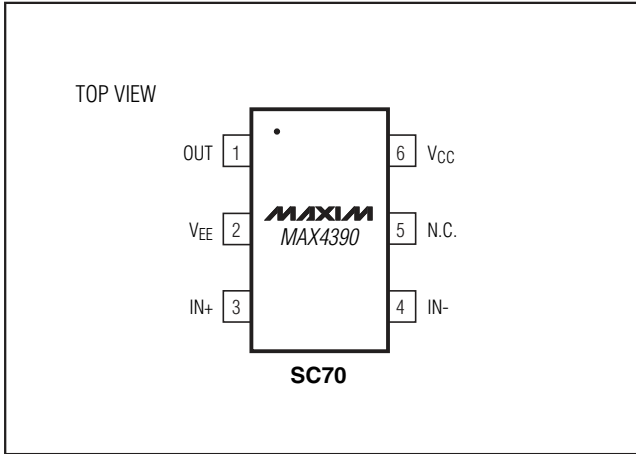

# Ultra-Small, Low-Cost, 85MHz Op Amps with Rail-to-Rail Outputs and Disable

## Pin Configurations (continued)

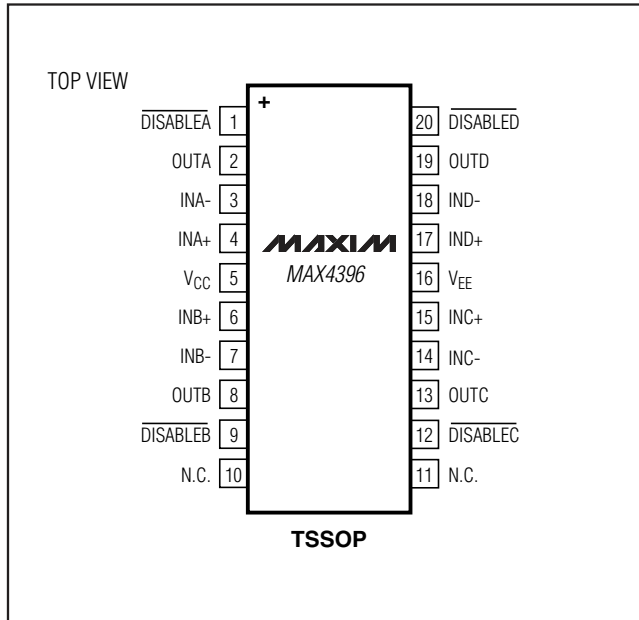

## Ordering Information (continued)

PART	TEMP RANGE	PIN-PACKAGE	TOP MARK
<b>MAX4392</b> ESA+T	-40°C to +85°C	8 SO	—
MAX4392EUA+T	-40°C to +85°C	8 μMAX	—
MAX4392EUA/V+T	-40°C to +85°C	8 μMAX	—
<b>MAX4393</b> EUB+T	-40°C to +85°C	10 μMAX	—
<b>MAX4394</b> ESD+T	-40°C to +85°C	14 SO	—
MAX4394ESD/V+T	-40°C to +85°C	14 SO	—
MAX4394EUD+T	-40°C to +85°C	14 TSSOP	—
MAX4394EUD/V+T	-40°C to +85°C	14 TSSOP	—
<b>MAX4395</b> ESD+T	-40°C to +85°C	14 SO	—
MAX4395ESD/V+T	-40°C to +85°C	14 SO	—
MAX4395EUD+T	-40°C to +85°C	14 TSSOP	—
MAX4395EUD/V+T	-40°C to +85°C	14 TSSOP	—
<b>MAX4396</b> EUP+T	-40°C to +85°C	20 TSSOP	—

+ Denotes a lead(Pb)-free/RoHs-compliant package.

V denotes an automotive qualified part.

T = Tape and reel.

## Selector Guide

PART	NO. OF AMPS	DISABLE
MAX4389	1	Yes
MAX4390	1	No
MAX4392	2	No
MAX4393	2	Yes
MAX4394	3	Yes
MAX4395	4	No
MAX4396	4	Yes

**MAX4389/MAX4390/MAX4392-MAX4396**

# Ultra-Small, Low-Cost, 85MHz Op Amps with Rail-to-Rail Outputs and Disable

## Package Information

For the latest package outline information and land patterns, go to [www.maxim-ic.com/packages](http://www.maxim-ic.com/packages). Note that a "+", "#", or "-" in the package code indicates RoHS status only. Package drawings may show a different suffix character, but the drawing pertains to the package regardless of RoHS status.

PACKAGE TYPE	PACKAGE CODE	DOCUMENT NO.
6 SC70	X5-1	<a href="#">21-0077</a>
6 SOT23	U6-1	<a href="#">21-0058</a>
5 SOT23	U5-1	<a href="#">21-0057</a>
8 $\mu$ MAX	U8-1	<a href="#">21-0036</a>
10 $\mu$ MAX	U10-2	<a href="#">21-0061</a>
8 SO, 14 SO	S8-2, S14-1	<a href="#">21-0041</a>
14 TSSOP, 20 TSSOP	U14-1, U20-3	<a href="#">21-0066</a>

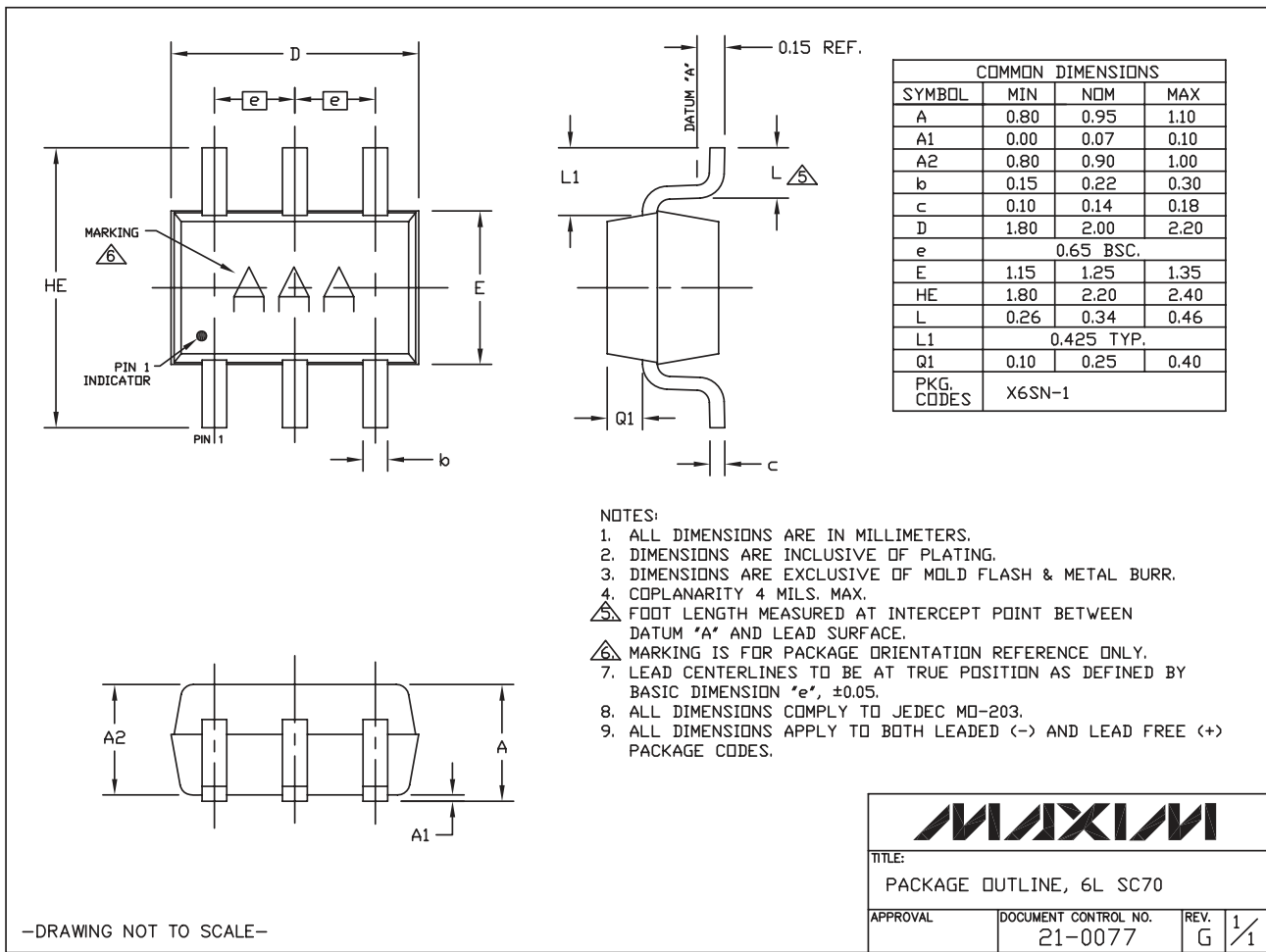

SC70, 6L.EPS



# Ultra-Small, Low-Cost, 85MHz Op Amps with Rail-to-Rail Outputs and Disable

## Package Information (continued)

For the latest package outline information and land patterns, go to [www.maxim-ic.com/packages](http://www.maxim-ic.com/packages). Note that a "+", "#", or "-" in the package code indicates RoHS status only. Package drawings may show a different suffix character, but the drawing pertains to the package regardless of RoHS status.

MAX4389/MAX4390/MAX4392-MAX4396

6LSOT.EPS

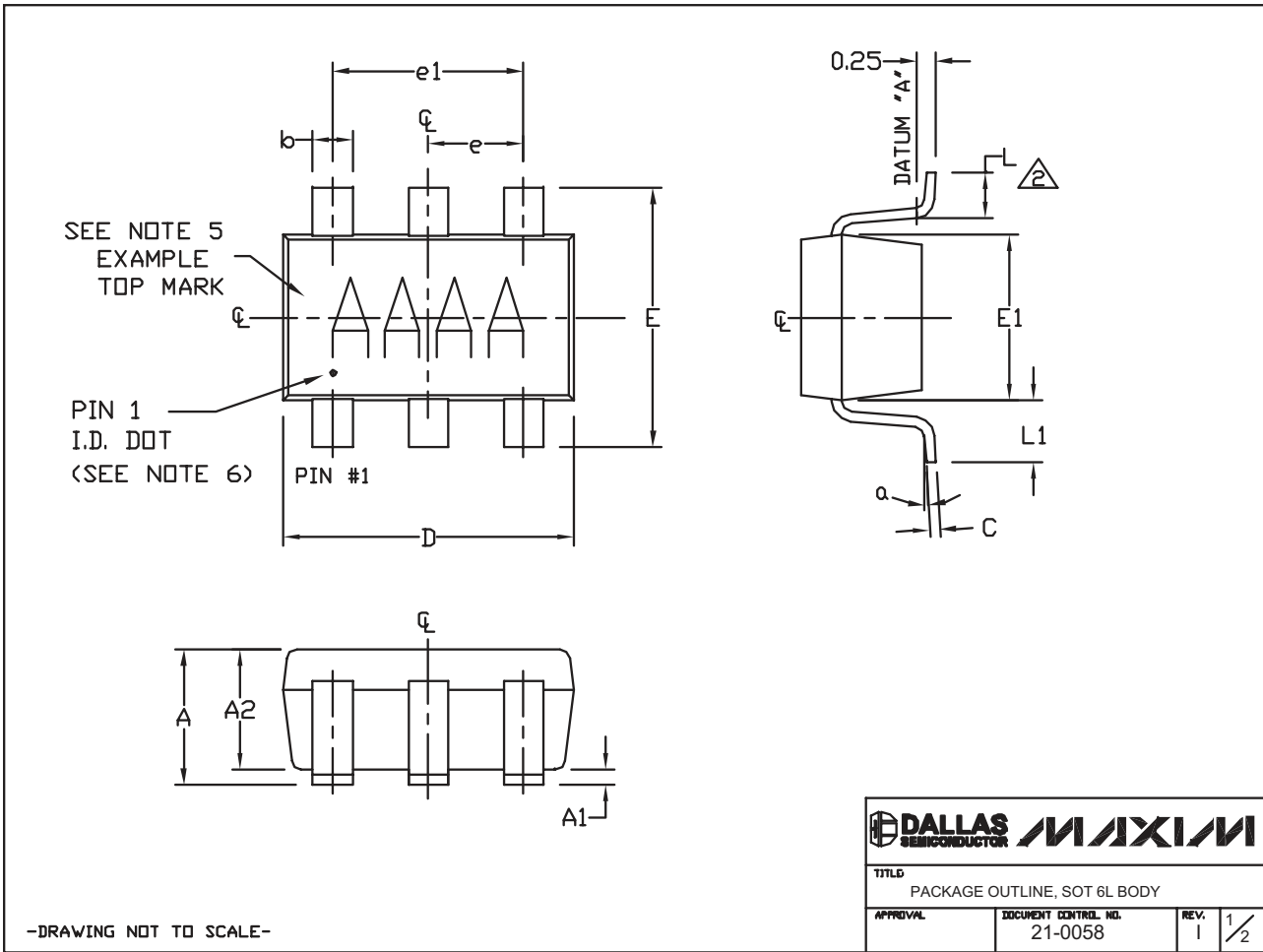

# Ultra-Small, Low-Cost, 85MHz Op Amps with Rail-to-Rail Outputs and Disable

## Package Information (continued)

For the latest package outline information and land patterns, go to [www.maxim-ic.com/packages](http://www.maxim-ic.com/packages). Note that a "+", "#", or "-" in the package code indicates RoHS status only. Package drawings may show a different suffix character, but the drawing pertains to the package regardless of RoHS status.

**NOTES:**

1. ALL DIMENSIONS ARE IN MILLIMETERS.
2. FOOT LENGTH MEASURED AT INTERCEPT POINT BETWEEN DATUM A & LEAD SURFACE.
3. PACKAGE OUTLINE EXCLUSIVE OF MOLD FLASH & METAL BURR. MOLD FLASH, PROTRUSION OR METAL BURR SHOULD NOT EXCEED 0.25mm.
4. PACKAGE OUTLINE INCLUSIVE OF SOLDER PLATING.
5. PIN 1 IS LOWER LEFT PIN WHEN READING TOP MARK FROM LEFT TO RIGHT. (SEE EXAMPLE TOP MARK)
6. PIN 1 I.D. DOT IS 0.3mm Ø MIN. LOCATED ABOVE PIN 1.
7. MEETS JEDEC MO17B, VARIATION AB.
8. SOLDER THICKNESS MEASURED AT FLAT SECTION OF LEAD BETWEEN 0.08mm AND 0.15mm FROM LEAD TIP.
9. LEAD TO BE COPLANAR WITHIN 0.1mm.
10. NUMBER OF LEADS SHOWN ARE FOR REFERENCE ONLY.
11. MARKING IS FOR PACKAGE ORIENTATION REFERENCE ONLY.

SYMBOL	MIN	NOMINAL	MAX
A	0.90	1.25	1.45
A1	0.00	0.05	0.15
A2	0.90	1.10	1.30
b	0.35	0.40	0.50
C	0.08	0.15	0.20
D	2.80	2.90	3.00
E	2.60	2.80	3.00
E1	1.50	1.625	1.75
L	0.35	0.45	0.60
L1	0.60 REF.		
e1	1.90 BSC.		
e	0.95 BSC.		
α	0°	2.5°	10°

PKG CODES:  
 U6-1, U6-2, U6-4, U6C-8,  
 U6SN-1, U6CN-2, U6S-3, U6F-5,  
 U6F-6, U6FH-5, U6FH-6

-DRAWING NOT TO SCALE-

TITLE			
PACKAGE OUTLINE, SOT 6L BODY			
APPROVAL	DOCUMENT CONTROL NO.	REV.	2/2
	21-0058	1	

# Ultra-Small, Low-Cost, 85MHz Op Amps with Rail-to-Rail Outputs and Disable

## Package Information (continued)

For the latest package outline information and land patterns, go to [www.maxim-ic.com/packages](http://www.maxim-ic.com/packages). Note that a "+", "#", or "-" in the package code indicates RoHS status only. Package drawings may show a different suffix character, but the drawing pertains to the package regardless of RoHS status.

MAX4389/MAX4390/MAX4392-MAX4396

SOT-23 5L EPS

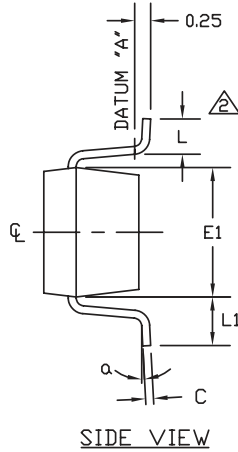
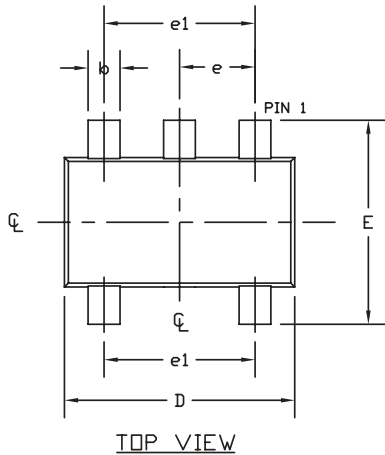

SYMBOL	MIN	NOM	MAX
A	0.90	1.25	1.45
A1	0.00	0.05	0.15
A2	0.90	1.10	1.30
b	0.35	0.40	0.50
C	0.08	0.15	0.20
D	2.80	2.90	3.00
E	2.60	2.80	3.00
E1	1.50	1.625	1.75
L	0.35	0.45	0.60
L1	0.60 REF		
e	0.95 BSC.		
e1	1.90 BSC.		
a	0°	2.5°	8°
PKG CODES: U5-1, U5-2			

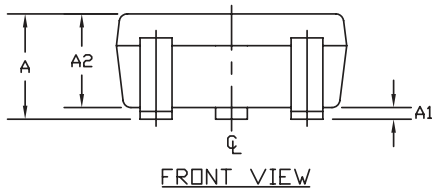

**NOTES:**

1. ALL DIMENSIONS ARE IN MILLIMETERS.
2. FOOT LENGTH MEASURED AT INTERCEPT POINT BETWEEN DATUM A & LEAD SURFACE.
3. PACKAGE OUTLINE EXCLUSIVE OF MOLD FLASH & METAL BURR. MOLD FLASH, PROTRUSION OR METAL BURR SHOULD NOT EXCEED 0.25 MM.
4. PACKAGE OUTLINE INCLUSIVE OF SOLDER PLATING.
5. MEETS JEDEC MQ178, VARIATION AA.
6. LEADS TO BE COPLANAR WITHIN 0.10 mm.
7. SOLDER THICKNESS MEASURED AT FLAT SECTION OF LEAD BETWEEN 0.08mm AND 0.15mm FROM LEAD TIP.

PROPRIETARY INFORMATION			
TITLE: PACKAGE OUTLINE, SOT-23, 5L			
APPROVAL:	DOCUMENT CONTROL NO. 21-0057	REV. F	1/1

# Ultra-Small, Low-Cost, 85MHz Op Amps with Rail-to-Rail Outputs and Disable

## Package Information (continued)

For the latest package outline information and land patterns, go to [www.maxim-ic.com/packages](http://www.maxim-ic.com/packages). Note that a "+", "#", or "-" in the package code indicates RoHS status only. Package drawings may show a different suffix character, but the drawing pertains to the package regardless of RoHS status.

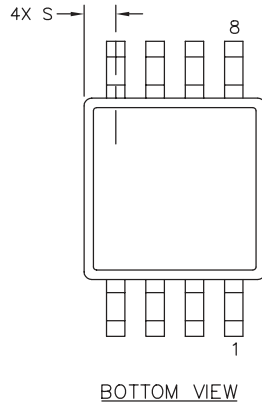
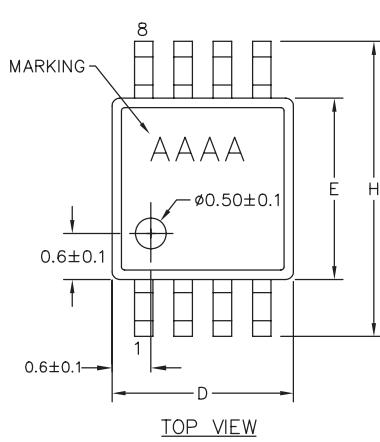

DIM	INCHES		MILLIMETERS	
	MIN	MAX	MIN	MAX
A	—	0.043	—	1.10
A1	0.002	0.006	0.05	0.15
A2	0.030	0.037	0.75	0.95
b	0.010	0.014	0.25	0.36
c	0.005	0.007	0.13	0.18
D	0.114	0.122	2.90	3.10
e	0.0256 BSC		0.65 BSC	
E	0.114	0.122	2.90	3.10
H	0.188	0.198	4.78	5.03
L	0.016	0.026	0.41	0.66
α	0°	6°	0°	6°
S	0.0207 BSC		0.5250 BSC	

PKG. CODES:  
U8-1; U8-3; U8CN-1

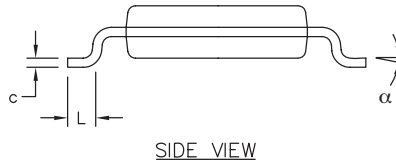
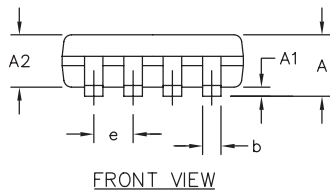

- NOTES:
1. D&E DO NOT INCLUDE MOLD FLASH.
  2. MOLD FLASH OR PROTRUSIONS NOT TO EXCEED 0.15MM (.006").
  3. CONTROLLING DIMENSION: MILLIMETERS.
  4. COMPLIES TO JEDEC MO-187, LATEST REVISION, VARIATION AA.
  5. MARKING SHOWN IS FOR PKG. ORIENTATION ONLY.
  6. ALL DIMENSIONS APPLY TO BOTH LEADED (-) AND PbFREE (+) PKG. CODES.

-DRAWING NOT TO SCALE-

<b>MAXIM</b>		
TITLE: PACKAGE OUTLINE, 8L uMAX/uSOP		
APPROVAL	DOCUMENT CONTROL NO. 21-0036	REV. L 1/1

# Ultra-Small, Low-Cost, 85MHz Op Amps with Rail-to-Rail Outputs and Disable

## Package Information (continued)

For the latest package outline information and land patterns, go to [www.maxim-ic.com/packages](http://www.maxim-ic.com/packages). Note that a "+", "#", or "-" in the package code indicates RoHS status only. Package drawings may show a different suffix character, but the drawing pertains to the package regardless of RoHS status.

MAX4389/MAX4390/MAX4392-MAX4396

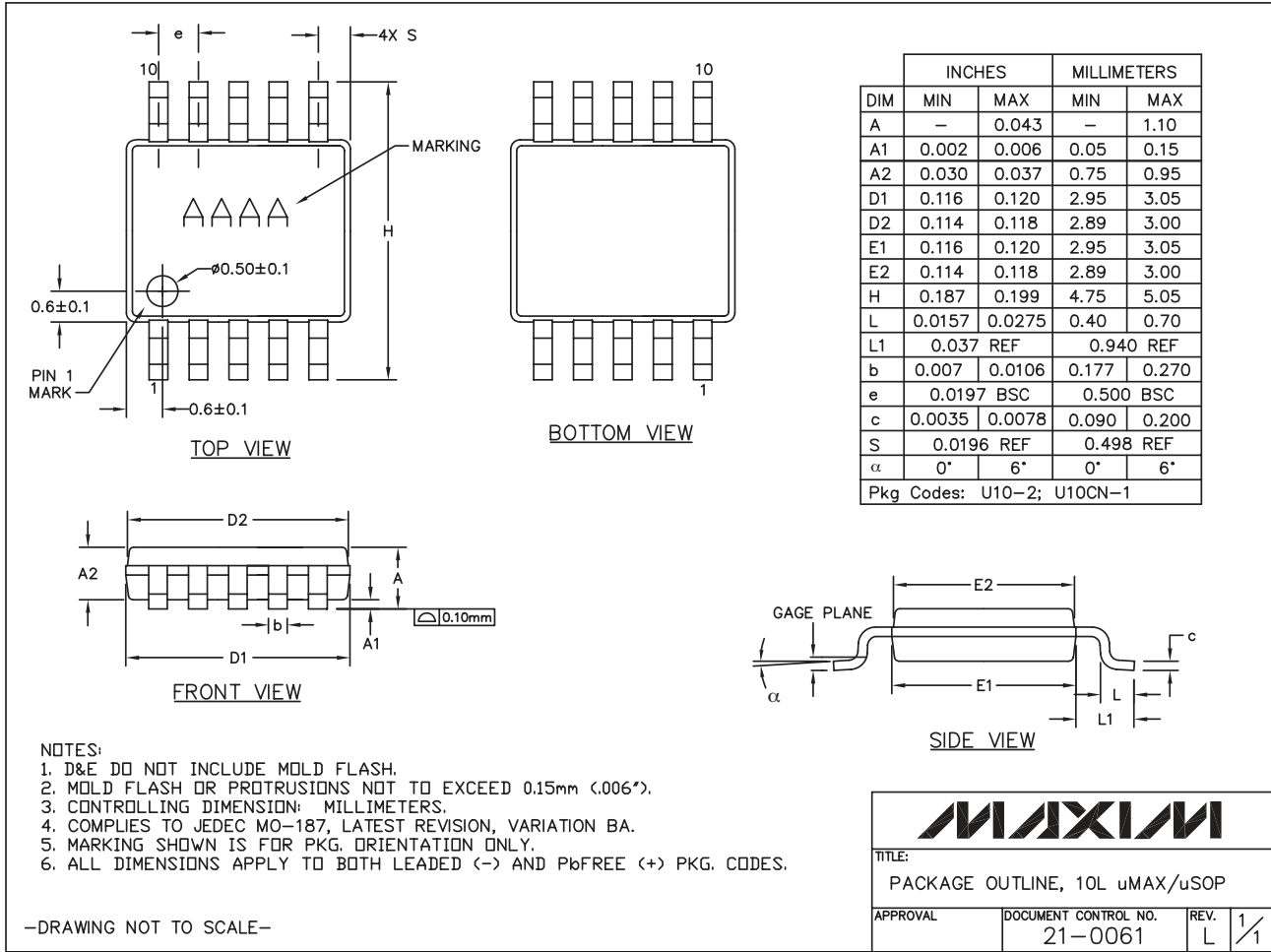

# Ultra-Small, Low-Cost, 85MHz Op Amps with Rail-to-Rail Outputs and Disable

## Package Information (continued)

For the latest package outline information and land patterns, go to [www.maxim-ic.com/packages](http://www.maxim-ic.com/packages). Note that a "+", "#", or "-" in the package code indicates RoHS status only. Package drawings may show a different suffix character, but the drawing pertains to the package regardless of RoHS status.

SOICN .EPS

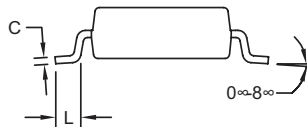
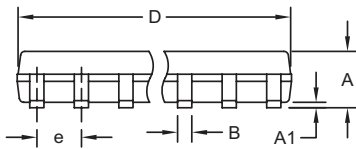
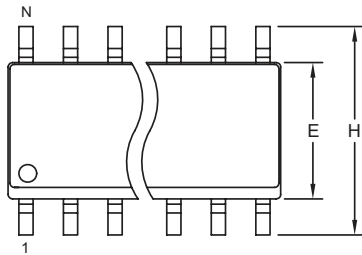

DIM	INCHES		MILLIMETERS	
	MIN	MAX	MIN	MAX
A	0.053	0.069	1.35	1.75
A1	0.004	0.010	0.10	0.25
B	0.014	0.019	0.35	0.49
C	0.007	0.010	0.19	0.25
e	0.050 BSC		1.27 BSC	
E	0.150	0.157	3.80	4.00
H	0.228	0.244	5.80	6.20
L	0.016	0.050	0.40	1.27

VARIATIONS:

DIM	INCHES		MILLIMETERS		N	MS012
	MIN	MAX	MIN	MAX		
D	0.189	0.197	4.80	5.00	8	AA
D	0.337	0.344	8.55	8.75	14	AB
D	0.386	0.394	9.80	10.00	16	AC

NOTES:

1. D&E DO NOT INCLUDE MOLD FLASH.
2. MOLD FLASH OR PROTRUSIONS NOT TO EXCEED 0.15mm (.006").
3. LEADS TO BE COPLANAR WITHIN 0.10mm (.004").
4. CONTROLLING DIMENSION: MILLIMETERS.
5. MEETS JEDEC MS012.
6. N = NUMBER OF PINS.

<small>PROPRIETARY INFORMATION</small>	
<small>TITLE:</small> PACKAGE OUTLINE, .150" SOIC	
<small>APPROVAL</small>	<small>DOCUMENT CONTROL NO.</small> 21-0041
<small>REV.</small> B	<small>1/1</small>

# Ultra-Small, Low-Cost, 85MHz Op Amps with Rail-to-Rail Outputs and Disable

## Package Information (continued)

For the latest package outline information and land patterns, go to [www.maxim-ic.com/packages](http://www.maxim-ic.com/packages). Note that a "+", "#", or "-" in the package code indicates RoHS status only. Package drawings may show a different suffix character, but the drawing pertains to the package regardless of RoHS status.

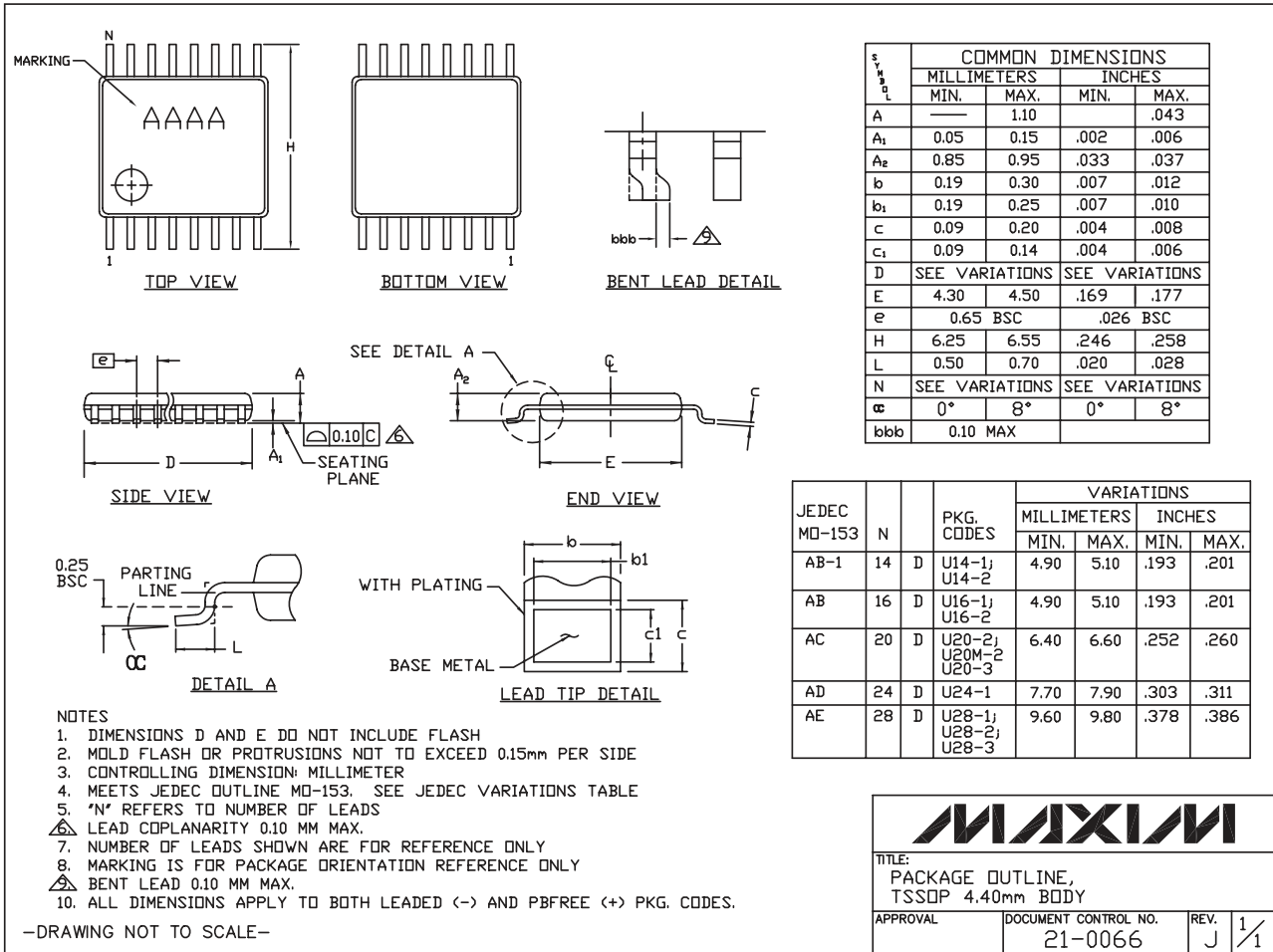

TSSOP4.40mm:EPS

MAX4389/MAX4390/MAX4392-MAX4396

# **Ultra-Small, Low-Cost, 85MHz Op Amps with Rail-to-Rail Outputs and Disable**

## **Revision History**

<b>REVISION NUMBER</b>	<b>REVISION DATE</b>	<b>DESCRIPTION</b>	<b>PAGES CHANGED</b>
4	11/09	Added automotive qualified parts	2, 15

*Maxim cannot assume responsibility for use of any circuitry other than circuitry entirely embodied in a Maxim product. No circuit patent licenses are implied. Maxim reserves the right to change the circuitry and specifications without notice at any time.*

24 **Maxim Integrated Products, 120 San Gabriel Drive, Sunnyvale, CA 94086 408-737-7600**