

40 to 60 W Constant Current LED Drivers with Tri-Mode Dimming™ (TRIAC, ELV & 0-10 V)

Nominal Input Voltage	Max. Output Power	Output Voltage	Output Current	Efficiency	Max. Case Temperature	THD	Power Factor	Dimming Method	Dimming Range	Startup Time
120 to 277 Vac, 220 to 240 Vac	60 W	24 to 56 Vdc	700 mA to 1.4 A CC	up to 87% typical	90°C (measured at the hot spot)	< 20%	> 0.9	Forward-Phase, Reverse-Phase & 0 - 10V	1 - 100% (% of lout)	400 ms

CC: Constant Current

Plastic Case:
 L 87 x W 60 x H 30mm
 (L 3.43 x W 2.36 x H 1.18 in)

FEATURES

- Same features as the ESP series but with a thermally-enhanced plastic case
- Compatible with TRIAC (forward-phase or leading-edge), ELV (reverse-phase or trailing-edge) and 0-10 V dimmers
- ESPTxxxW models: TRIAC and ELV dimming only at 120 Vac
- ESPTxxxE models: ELV dimming only at 230 Vac
- 90°C maximum case hot spot temperature
- Class 2 power supply
- Lifetime: 50,000 hours at 70°C case hot spot temperature (some models have higher lifetime. Check lifetime curves in page 6)
- IP66-rated case with silicone-based potting
- Two 0-10V dimming profiles are available:
 - Linear 0-10 V dimming: 10V=100%, 1V=10%, 0.1V=1%.
 - Non-linear 0-10V dimming: 10V to 8.1V=100%, 1V to 0.8V=1%, <0.8V dim-to-off.
- Protections: output open load, over-current and short-circuit (hiccup), and over-temperature with auto recovery
- Conducted and radiated EMI: Compliant with FCC CFR Title 47 Part 15 Class B (120 Vac) and Class A (277 Vac)
- Complies with ENERGY STAR®, DLC (DesignLight Consortium®) and CA Title 24 technical requirements
- Worldwide safety approvals



CA Title 24

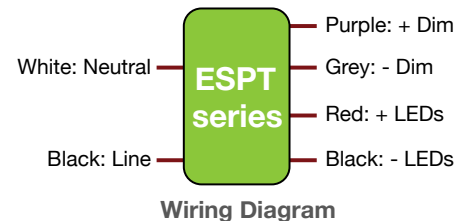
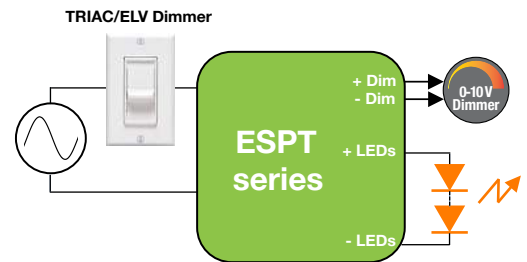

APPLICATIONS

- Indoor & outdoor
- Recessed lighting (downlights)
- Commercial & residential lighting
- Architectural lighting
- Office Lighting



40 to 60 W Constant Current LED Drivers with Tri-Mode Dimming™ (TRIAC, ELV & 0-10 V)

1 - ORDERING INFORMATION - MODEL DESCRIPTION

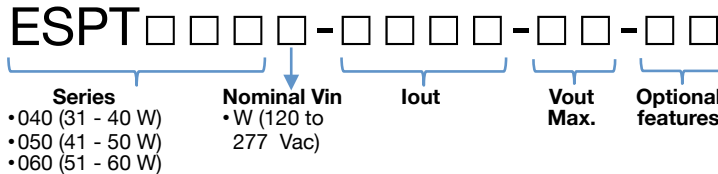

ERP Part Number	Nominal Input Voltage (Vac)	Iout (mA)	Max Output Power (W)	Vout Min (Vdc)	Vout Nom (Vdc)	Vout Max (Vdc)	Open Loop (no load) Voltage (Vdc)	Comments
ESPT040W: 31-40W								
ESPT040W-0700-56	120 to 277	700	39.2	40	50.4	56	60	Linear 0-10V Dimming Profile (10V=100%, 1V=10%)
ESPT040W-0800-42-Z1 ⁽¹⁾	120 to 277	800	33.6	24	37.8	42	50	Non-linear 0-10V Dimming Profile (10V to 8.1V=100%, 1V to 0.8V=1%, <0.8V dim-to-off)
ESPT040W-0900-42-Z1 ⁽¹⁾	120 to 277	900	37.8	24	37.8	42	50	Non-linear 0-10V Dimming Profile (10V to 8.1V=100%, 1V to 0.8V=1%, <0.8V dim-to-off)
ESPT050W: 41-50W								
ESPT050W-1050-42-Z1 ⁽¹⁾	120 to 277	1050	44.1	24	37.8	42	50	Non-linear 0-10V Dimming Profile (10V to 8.1V=100%, 1V to 0.8V=1%, <0.8V dim-to-off)
ESPT050W-1200-42-Z1 ⁽¹⁾	120 to 277	1200	50.4	24	37.8	42	50	Non-linear 0-10V Dimming Profile (10V to 8.1V=100%, 1V to 0.8V=1%, <0.8V dim-to-off)
ESPT050W-1400-34	120 to 277	1400	47.6	23	30.6	34	44.2	Linear 0-10V Dimming Profile (10V=100%, 1V=10%)
ESPT060W: 51-60W								
ESPT060W-1400-42-Z1 ⁽¹⁾	120 to 277	1400	58.8	24	37.8	42	50	Non-linear 0-10V Dimming Profile (10V to 8.1V=100%, 1V to 0.8V=1%, <0.8V dim-to-off)
ESPT040E: 31 to 40 W								
ESPT040E-0800-42	220 to 240	800	33.6	24	37.8	42	50	Linear 0-10V Dimming Profile (10V=100%, 1V=10%)
ESPT040E-0900-42	220 to 240	900	37.8	24	37.8	42	50	Linear 0-10V Dimming Profile (10V=100%, 1V=10%)
ESPT050E: 41 to 50 W								
ESPT050E-1050-42	220 to 240	1050	44.1	24	37.8	42	50	Linear 0-10V Dimming Profile (10V=100%, 1V=10%)
ESPT050E-1200-42	220 to 240	1200	50.4	24	37.8	42	50	Linear 0-10V Dimming Profile (10V=100%, 1V=10%)
ESPT060E: 51 to 60 W								
ESPT060E-1400-42	220 to 240	1400	58.8	24	37.8	42	50	Linear 0-10V Dimming Profile (10V=100%, 1V=10%)

Notes:

- ESPT models with the “-Z1” suffix exhibit a non-linear 0-10V dimming profile with dim-to-off: 10V to 8.1V=100%, 1V to 0.8V=1%, <0.8V dim-to-off.
- The ESPT driver case must be mounted by using a minimum of two metal clips. By default, the ESPT driver is shipped with 2 metal clips. Additional metal clips can be ordered with the following part numbers:
 - ESPT-CLIPS-100: bag of 100 clips
 - ESPT-CLIPS-1k: bag of 1000 clips

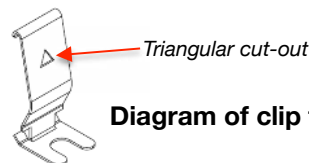

Diagram of clip for ESPT series

- For additional options of output current and output voltage, contact your sales representative or send an email to: SaveEnergy@ERP-Power.com

40 to 60 W Constant Current LED Drivers with Tri-Mode Dimming™ (TRIAC, ELV & 0-10 V)

2 - INPUT SPECIFICATION (@25°C ambient temperature)

	Units	Minimum	Typical	Maximum	Notes
Input Voltage Range (Vin) - ESPTxxxW models - ESPTxxxE models	Vac	90 180	120, 277 230	305 264	•The rated output current for each model is achieved at Vin≥108 Vac & at Vin≥198 Vac for ESPTxxxW models, and at Vin≥209 Vac for ESPTxxxE models. •At nominal load
Input Frequency Range - ESPTxxxW - ESPTxxxE	Hz	47 47	60 50	63 53	
Input Current (Iin)	A			0.7 A @ 120 Vac 0.4 A @ 230 Vac 0.35 A @ 277 Vac	
Power Factor (PF)		0.9	> 0.9		At nominal input voltage and with nominal LED voltage
Inrush Current	A	Meets NEMA-410 requirements			•At any point on the sine wave and 25°C
Leakage Current	µA			250 µA @ 120 Vac 500 µA @ 230 Vac 600 µA @ 277 Vac	Measured per IEC60950-1
Input Harmonics	Complies with IEC61000-3-2 for Class C equipment				
Total Harmonics Distortion (THD)				20%	•At nominal input voltage and nominal LED voltage •Complies with DLC (Design Light Consortium) technical requirements
Efficiency	%	-	up to 87%	-	•Measured with nominal input voltage, a full sinusoidal wave form and without dimmer connected.
Isolation	The AC input to the main DC output is isolated and meets Class II reinforced/double insulation power supply <input type="checkbox"/>				

3 - OUTPUT SPECIFICATION (@25°C ambient temperature)

	Units	Minimum	Typical	Maximum	Notes
Output Voltage (Vout)	Vdc	24		56	See ordering information for details
Output Current (Iout)	mA	700		1400	•See ordering information for details •The rated output current for each model is achieved at Vin≥108 Vac & at Vin≥198 Vac for ESPTxxxW models, and at Vin≥209 Vac for ESPTxxxE models.
Output Current Regulation	%	-5		5	•At nominal AC line voltage •Includes load and current set point variations
Output Current Overshoot	%	-	-	10	The driver does not operate outside of the regulation requirements for more than 500 ms during power on with nominal LED load and without dimmer.
Ripple Current	≤ 33% of rated output current for each model				•Measured at nominal LED voltage and nominal input voltage without dimming •Calculated in accordance with the IES Lighting Handbook, 9th edition
Dimming Range (% of Iout)	%	1		100	•The dimming range is dependent on each specific dimmer. It may not be able to achieve 1% dimming with some dimmers. •Dimming performance is optimal when the driver is operated at its nominal output voltage matching the LED nominal Vf (forward voltage). Dimming performance may vary when the driver is operated near its minimum output voltage.
Start-up Time	ms			400	•Measured from application of AC line voltage to the time where light is visible (about 10% of rated output current)
				500	•Measured from application of AC line voltage to 100% light output •Complies with California Title 24 and ENERGY STAR® luminaire specification

40 to 60 W Constant Current LED Drivers with Tri-Mode Dimming™ (TRIAC, ELV & 0-10 V)

4 - 0-10 V DIMMING CONTROL (@25°C ambient temperature)

	Units	Minimum	Typical	Maximum	Notes
+Dim Signal, -Dim Signal	The ESPT series operate only with 0-10V dimmers that sink current. The method to dim the output current of the driver is done via the +Dim/-Dim Signal pins. The +Dim/-Dim signal pins can be used to adjust the output setting via a standard commercial wall dimmer, an external control voltage source (0 to 10 Vdc), or a variable resistor when using the recommended number of LEDs. The dimming input permits 1% to 100% dimming.				
Dimming Range (% of Iout)	%	1		100	<ul style="list-style-type: none"> The dimming range is dependent on each specific dimmer. It may not be able to achieve 1% dimming with some dimmers. Dimming performance is optimal when the driver is operated at its nominal output voltage matching the LED nominal Vf (forward voltage). Dimming performance may vary when the driver is operated near its minimum output voltage.
Current Supplied by the +Dim Signal Pin	mA			1	
Output Current Tolerance While Being Dimmed	%			±8	The tolerance of the output current while being dimmed is ≤ +/-8% until down to 1V.
Isolation	The 0-10 V circuit is isolated from the AC input and meets Class II reinforced/double insulation power supply. <input type="checkbox"/>				

5 - ENVIRONMENTAL CONDITIONS

	Units	Minimum	Typical	Maximum	Notes
Operating Case Temperature (Tc)	°C	-30		+70	Case temperature measured at the hot spot •tc (see label in page 12)
Maximum Case Temperature (Tc)	°C			+90	Case temperature measured at the hot spot •tc (see label in page 12)
Storage Temperature	°C	-40		+85	
Humidity	%	5	-	95	Non-condensing
Cooling	Convection cooled				
Acoustic Noise	dBA			22	Measured at a distance of 1 foot (30 cm), without and with approved dimmers
Mechanical Shock Protection	per EN60068-2-27				
Vibration Protection	per EN60068-2-6 & EN60068-2-64				
MTBF	> 300,000 hours when operated at nominal input and output conditions, and at Tc ≤ 70°C				
Lifetime	hours	50,000			<ul style="list-style-type: none"> At Tc ≤ 70°C maximum case hot spot temperature (see hot spot •tc on label in page 12) Other models in the ESPT series have a longer lifetime. See details in section 8.
Warranty	5 years at Tc ≤ 70°C				

40 to 60 W Constant Current LED Drivers with Tri-Mode Dimming™ (TRIAC, ELV & 0-10 V)

6 - EMC COMPLIANCE AND SAFETY APPROVALS

EMC Compliance					
Conducted and Radiated EMI	FCC CFR Title 47 Part 15 Class B at 120 Vac and Class A at 277 Vac				
Harmonic Current Emissions	IEC61000-3-2 For Class C equipment				
Voltage Fluctuations & Flicker	IEC61000-3-3				
Immunity Compliance	ESD (Electrostatic Discharge)	IEC61000-4-2 6 kV contact discharge, 8 kV air discharge, level 3			
	RF Electromagnetic Field Susceptibility	IEC61000-4-3 3 V/m, 80 - 1000 MHz, 80% modulated at a distance of 3 meters			
	Electrical Fast Transient	IEC61000-4-4 ± 2 kV on AC power port for 1 minute, ±1 kV on signal/control lines			
	Surge	IEC61000-4-5 ± 1 kV line to line (differential mode) /± 2 kV line to common mode ground (tested to secondary ground) on AC power port, ±0.5 kV for outdoor cables ANSI/IEEE c62.41.1-2002 & c62.41.2-2002 category A, 2.5 kV ring wave			
	Conducted RF Disturbances	IEC61000-4-6 3V, 0.15-80 MHz, 80% modulated			
	Voltage Dips	IEC61000-4-11 >95% dip, 0.5 period; 30% dip, 25 periods; 95% reduction, 250 periods			
Safety Agency Approvals					
UL	UL8750 recognized Class 2				
cUL	CAN/CSA C22.2 No. 250.13-14 LED equipment for lighting applications				
Safety					
	Units	Minimum	Typical	Maximum	Notes
Hi Pot (High Potential) or Dielectric voltage-withstand	Vdc	4242			<ul style="list-style-type: none"> Insulation between the input (AC line and Neutral) and the output Tested at the RMS voltage equivalent of 3000 Vac

7 - PROTECTION FEATURES

Under-Voltage (Brownout)

The ESPT series provides protection circuitry such that an application of an input voltage below the minimum stated in paragraph 1 (Input Specification) shall not cause damage to the driver.

Short Circuit

The ESPT series is protected against short-circuit such that a short from any output to return shall not result in a fire hazard or shock hazard. The driver shall hiccup as a result of a short circuit or over current fault. Removal of the fault will return the driver to within normal operation. The driver shall recover, with no damage, from a short across the output for an indefinite period of time.

Internal Over temperature Protection

The ESPT series incorporates circuitry that prevents internal damage due to an over temperature condition. An over temperature condition may be a result of an excessive ambient temperature or as a result of an internal failure. When the over temperature condition is removed, the driver shall automatically recover.

Output Open Load

When the LED load is removed, the output voltage of the ESPT series is limited to 1.3 times the maximum output voltage of each model.

40 to 60 W Constant Current LED Drivers with Tri-Mode Dimming™ (TRIAC, ELV & 0-10 V)

8 - PREDICTED LIFETIME VERSUS CASE AND AMBIENT TEMPERATURE

Lifetime is defined by the measurement of the temperatures of all the electrolytic capacitors whose failure would affect light output under the nominal LED load and worst case AC line voltage. The graphs in figure 1 are determined by the electrolytic capacitor with the shortest lifetime, among all electrolytic capacitors. It represents a worst case scenario in which the LED driver is powered 24 hours/day, 7 days/week. The lifetime of an electrolytic capacitor is measured when any of the following changes in performance are observed:

- | | |
|--|--|
| 1) Capacitance changes more than 20% of initial value | 2) Dissipation Factor ($\tan \delta$): 150% or less of initial specified value |
| 3) Equivalent Series Resistance (ESR): 150% or less of initial specified value | 4) Leakage current: less of initial specified value |

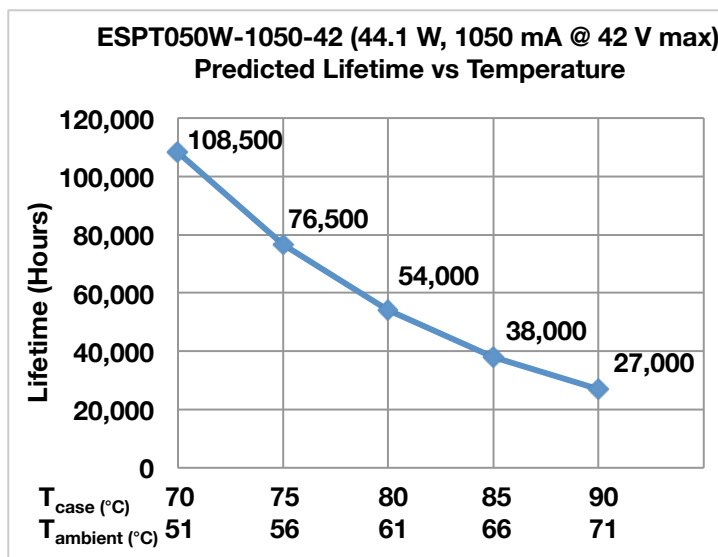

Figure 1

Notes:

- The ambient temperature $T_{ambient}$ and the differential between $T_{ambient}$ and T_{case} mentioned in the above graphs are relevant only as long as both the driver and the light fixture are exposed to the same ambient room temperature. If the LED driver is housed in an enclosure or covered by insulation material, then the ambient room temperature is no longer valid. In this situation, please refer only to the case temperature T_{case} .
- It should be noted the graph "Lifetime vs. Ambient Temperature" may have an error induced in the final application if the mounting has restricted convection flow around the case. For applications where this is evident, the actual case temperature measured at the T_c point in the application should be used for reliability calculations.

40 to 60 W Constant Current LED Drivers with Tri-Mode Dimming™ (TRIAC, ELV & 0-10 V)

9 - PHASE-CUT DIMMING

Dimming of the driver is possible with standard TRIAC-based incandescent dimmers that chop the AC voltage as shown in Figure 2, or with ELV dimmers. During the rapid rise time of the AC voltage when the dimmer turns on, the driver does not generate any voltage or current oscillations, and inrush current is controlled. During the on-time of the AC input, the driver regulates the output current based upon the conduction angle. The RMS value of the driver output current is proportional to the on-time of the AC input voltage. When operating with an incandescent dimmer, the RMS output current varies depending upon the conduction angle and RMS value of the applied AC input voltage. Figure 3 shows the typical output current versus conduction angle at nominal input voltage.

The ESPT series offers tri-mode dimming compatibility with both phase-cut (reverse-phase and forward-phase) and 0-10V dimmers. Phase-cut dimming always has priority over 0-10 V dimming.

Please note the compatibility for the different ESPT models:

- ESPTxxxW models: TRIAC and ELV dimming only at 120 Vac
- ESPTxxxE models: ELV dimming only at 230 Vac

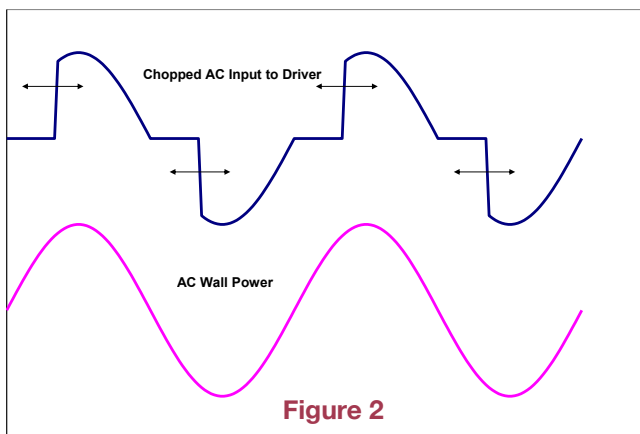

Figure 2

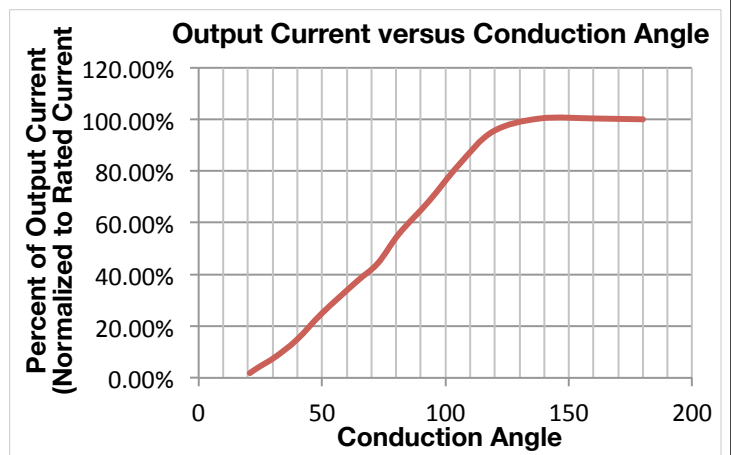

Figure 3

10 - COMPATIBLE PHASE-CUT DIMMERS & DIMMING RANGE

120Vac Dimmers					
Mfg.	Model	Mfg.	Model	Mfg.	Model
Lutron	S-603PG	Lutron	DVELV-303P	Lutron	CT-103P
Leviton	IPI06-1LZ	Lutron	SELV-300P	Cooper	SLC03P
Leviton	6631-2	Leviton	6683-IW	Leviton	IPE04
Lutron	DVCL-153P	Leviton	6161	Lutron	MAELV-600
Lutron	DV-600P	Leviton	6633-P	Lutron	FAELV-500
Lutron	TGCL-153P	Lutron	TG-600P	Lightolier	ZP260QEW
Lutron	S-600P	Cooper	DLC03P	Cooper	DAL06P
Leviton	VPE06	Lutron	LG-600P		

Dimming compatibility charts are available for each model in the ESPT series. Please contact your sales representative or send an email to: SaveEnergy@erp-power.com.

40 to 60 W Constant Current LED Drivers with Tri-Mode Dimming™ (TRIAC, ELV & 0-10 V)

11 - 0-10 V DIMMING

The ESPT drivers operate only with 0-10V dimmers that sink current. They are not designed to operate with 0-10V control systems that source current, as used in theatrical/entertainment systems. Developed in the 1980's, the 0-10V sinking current control method is adopted by the International Electrotechnical Commission (IEC) as a part of their IEC Standard 60929 Annex E.

The method to dim the output current of the driver is done via the +Dim/-Dim Signal pins. The +Dim/-Dim Signal pins respond to a 0 to 10 V signal, delivering 1% to 100% of the output current based on rated current for each model. A pull-up resistor is included internal to the driver. When the +Dim wire (purple) is short circuited to the -Dim wire (grey) or to the -LED wire (black), a small amount of current may be present on the output and, in that condition, shimmering may be observed. If the +Dim input is ≤ 1 V and ≥ 0.6 V, the output current is still present, as shown in figure 4. **Please note that short circuiting the +Dim wire (purple) to the -Dim wire (grey) does not guarantee that the output current is turned off. In some models, the current may turn off when short circuiting the +Dim wire to the -Dim wire. In other models, there may be a small amount of current still present.**

If the +Dim input is > 10 V or open circuited, the output current is programmed to 100% of the rated current.

When not used, the -Dim wire (grey) and the +Dim wire (purple) can be individually capped or cut off. In this configuration, no dimming is possible and the driver delivers 100% of its rated output current.

The maximum source current (flowing from the driver to the 0-10V dimmer) supplied by the +Dim Signal pin is ≤ 1 mA. The tolerance of the output current while being dimmed shall be $\pm 8\%$ typical until down to 1 V.

There are two 0-10V dimming transfer functions available: a linear curve where 10V = 100% of the output current and 1V = 10% of the output current (seen in figure 4) or a non-linear curve where 10V to 8.1V=100% of Iout, 1V to 0.8V=1% of Iout, and Dim-to-off < 0.8 V (seen in figure 5).

Models with the "-Z1" suffix exhibit a non-linear 0-10 V dimming profile with dim-to-off.

The non-linear curve is recommended when using standard in wall 0-10V logarithmic dimmers to avoid having insufficient source current available to pull the dimmer up to 10V and to account for the inability of the dimmer to pull below approximately 0.9V. In these types of installations, the modified transfer function will ensure 100% light output and dimming to 1%, regardless of the number of drivers on the 0-10V dimming line. Please contact your sales representative or send an email to SaveEnergy@erp-power.com for additional information on the non-linear 0-10V dimming profile.

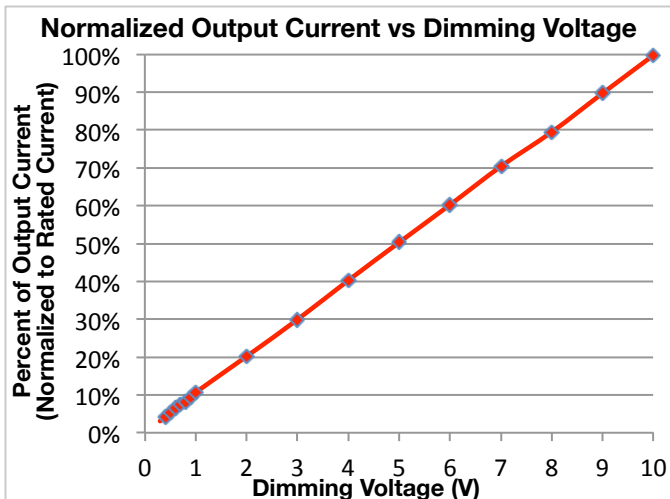

Figure 4

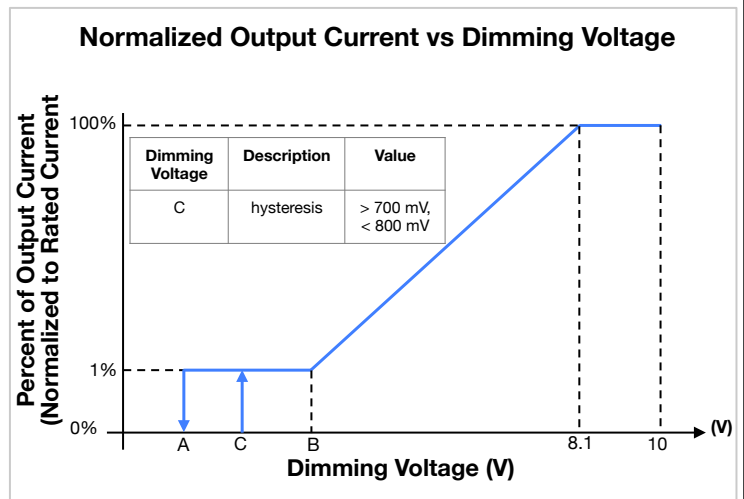

Figure 5

40 to 60 W Constant Current LED Drivers with Tri-Mode Dimming™ (TRIAC, ELV & 0-10 V)

11 - 0-10 V DIMMING (CONTINUED)

A fixed or variable resistor can be also used from the +Dim signal pin to the -Dim pin to adjust the output current. Figure 6 show the relationship of the output current to a resistor connected across the 0-10V dimming input. This is a typical graph for the entire ESPT series but is not specific to a particular model. This graph may vary from one model to the next.

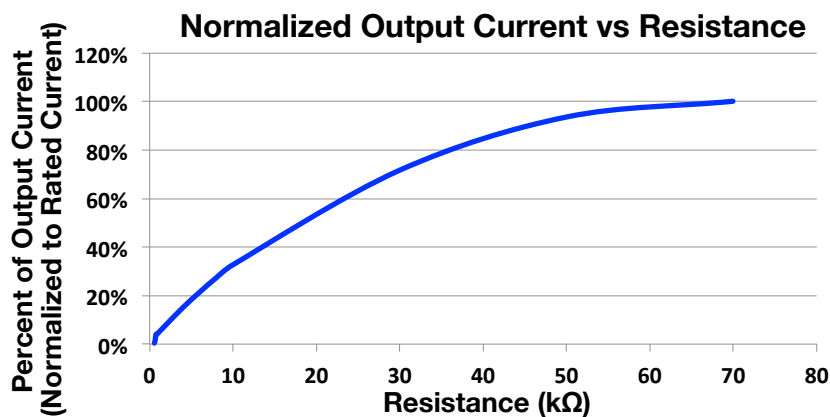

Figure 6

12 - COMPATIBLE 0-10 V DIMMERS

- Lutron, Nova series (part number NFTV)
- Lutron, Diva series (part number DVTV)
- Leviton, IllumaTech series (part number IP710-DL)

40 to 60 W Constant Current LED Drivers with Tri-Mode Dimming™ (TRIAC, ELV & 0-10 V)

13 - MECHANICAL DETAILS

- Packaging Options:** Plastic case
- I/O Connections:** Flying leads, 18 AWG on power leads, 22 AWG on 0-10V dimming wires, 152 mm (6 in) long, 105°C rated, stranded, stripped by approximately 9.5mm and tinned. All the wires, on both input and output, have a 300 V insulation rating.
- Ingress Protection:** IP66 rated
- Flammability Rating:** UL94 V-0. For 5VA flammability, please order the ESPV series.
- Mounting Instructions:** The ESPT driver case must be secured on a flat surface through a minimum of 2 metal clips. By default, the ESPT driver is shipped with 2 metal clips. Additional metal clips can be ordered with the following part numbers:
- ESPT-CLIPS-100: bag of 100 clips
 - ESPT-CLIPS-1k: bag of 1000 clips

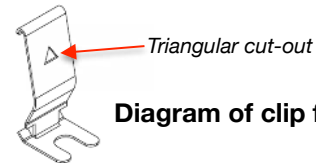
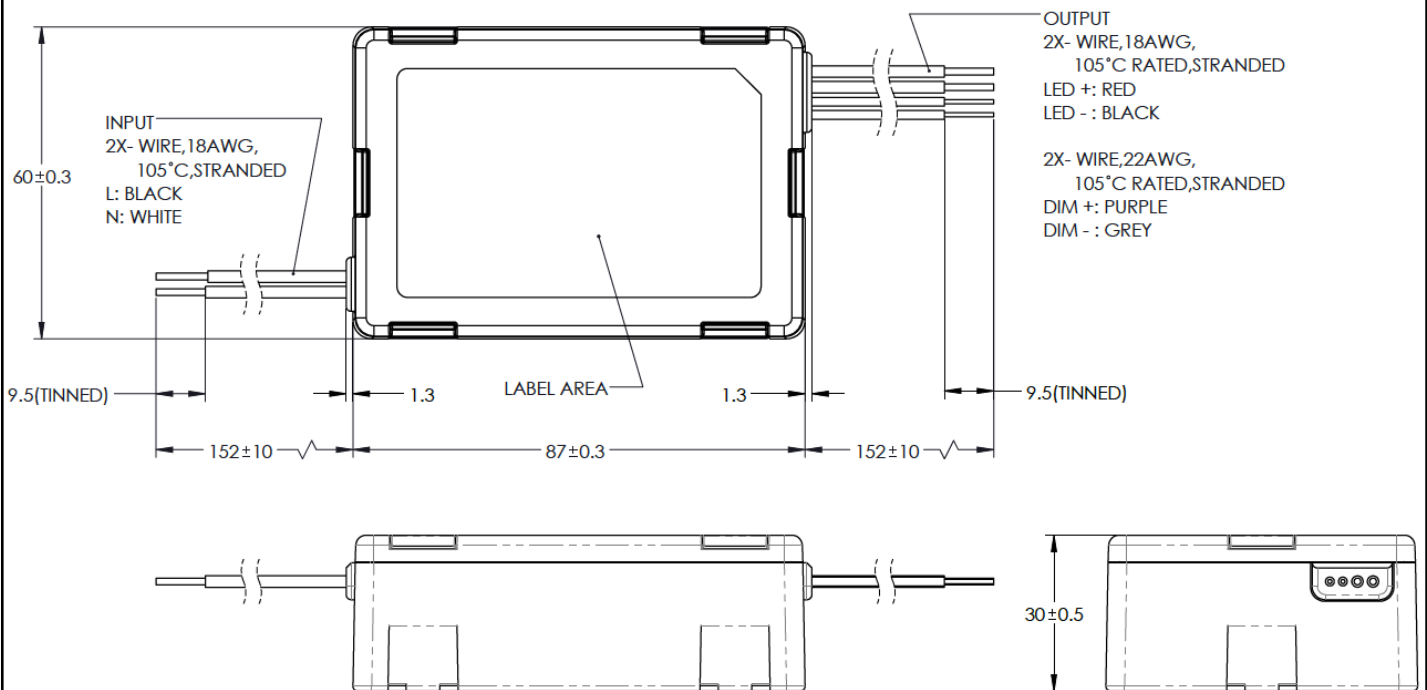

Diagram of clip for ESPT series

14 - OUTLINE DRAWINGS

- Dimensions:** L 87 x W 60 x H 30 mm (L 3.43 x W 2.36 x H 1.18 in)
- Volume:** 156.6 cm³ (9.55 in³)
- Weight:** 222 g (7.8 oz)



All dimensions are in mm

Figure 7

40 to 60 W Constant Current LED Drivers with Tri-Mode Dimming™ (TRIAC, ELV & 0-10 V)

14 - OUTLINE DRAWINGS (CONTINUED)

Mounting Instructions:

The ESPT driver case must be secured on a flat surface through a minimum of 2 metal clips.

If only 2 metal clips are used, please use any of the following recommended combinations for using the metal clips:

- a-a
- b-b
- c-c

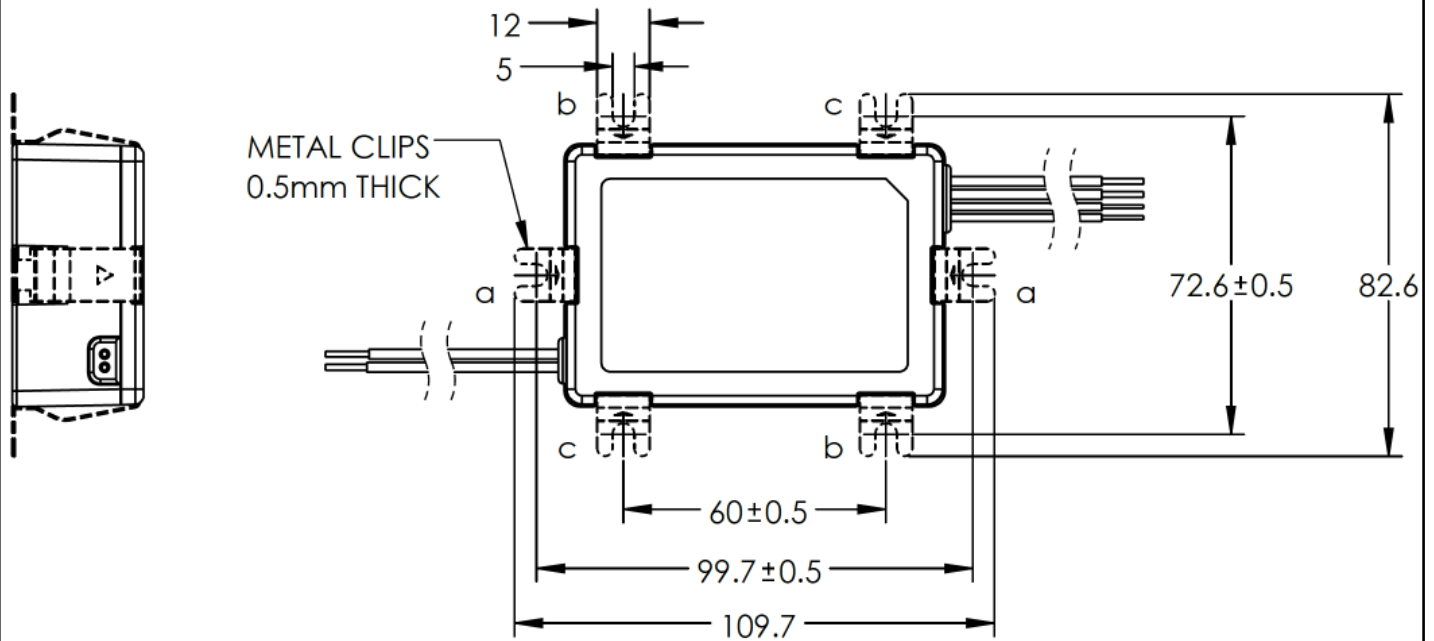

All dimensions are in mm

Figure 8



ESPT Series

ESPT040 31-40 W
ESPT050 41-50 W
ESPT060 51-60 W

40 to 60 W Constant Current LED Drivers with Tri-Mode Dimming™ (TRIAC, ELV & 0-10 V)

15 - LABELING

The ESPT050W-1050-42-Z1 is used in figure 8 as an example to illustrate a typical label.

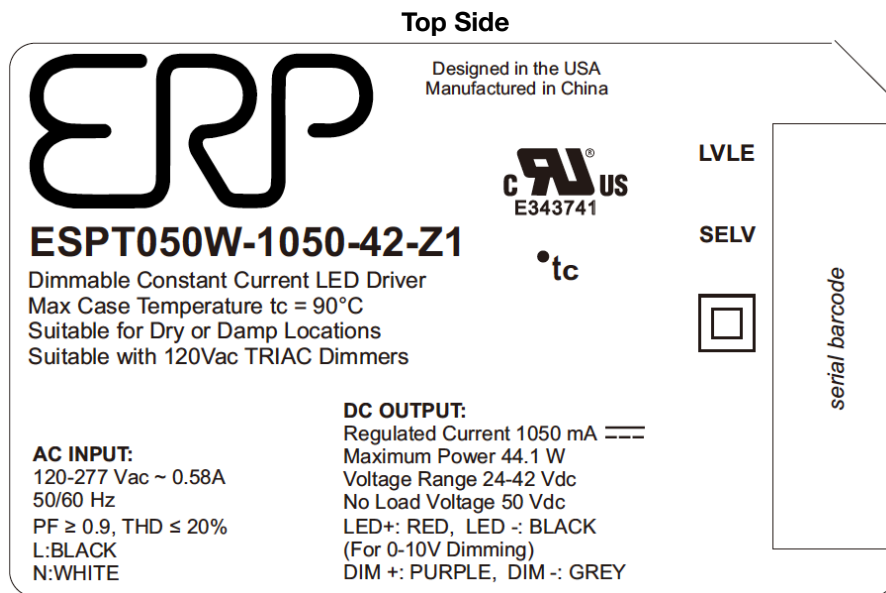

Figure 9

USA Headquarters
 Tel: +1-805-517-1300
 Fax: +1-805-517-1411
 893 Patriot Drive, Suite E,
 Moorpark, CA 93021, USA

CHINA Operations
 Tel: +86-756-6266298
 Fax: +86-756-6266299
 No. 8 Pingdong Road 2
 Zhuhai, Guangdong, China 519060

ERP Power, LLC (ERP) reserves the right to make changes without further notice to any products herein. ERP makes no warranty, representation or guarantee regarding the suitability of its products for any particular purpose, nor does ERP assume any liability arising out of the application or use of any product or circuit, and specifically disclaims any and all liability, including without limitation special, consequential or incidental damages. "Typical" parameters which may be provided in ERP data sheets and/or specifications can and do vary in different applications and actual performance may vary over time. All operating parameters, including "Typicals" must be validated for each customer application by customer's technical experts. ERP does not convey any license under its patent rights nor the rights of others. ERP products are not designed, intended, or authorized for use as components in systems intended for surgical implant into the body, or other applications intended to support or sustain life, or for any other application in which the failure of the ERP product could create a situation where personal injury or death may occur. Should Buyer purchase or use ERP products for any such unintended or unauthorized application, Buyer shall indemnify and hold ERP and its officers, employees, subsidiaries, affiliates, and distributors harmless against all claims, costs, damages, and expenses, and reasonable attorney fees arising out of, directly or indirectly, any claim of personal injury or death associated with such unintended or unauthorized use, even if such claim alleges that ERP was negligent regarding the design or manufacture of the part. ERP is an Equal Opportunity/Affirmative Action Employer. This literature is subject to all applicable copyright laws and is not for resale in any manner.