

# ***bq24170EVM Stand-Alone Synchronous, Switch-Mode, Battery-Charge Controller With Integrated N-MOSFETs and Power Path Selector***

This user's guide describes the features and operation of the bq24170EVM Evaluation Module (EVM). The EVM assists users in evaluating the bq24170 synchronous battery charger. The EVM is also called the HPA610A. The manual includes the bq24170EVM bill of materials, board layout, and schematic.

## **Contents**

1	Introduction .....	2
1.1	EVM Features .....	2
1.2	General Description .....	2
1.3	I/O Description .....	2
1.4	Control and Key Parameters Settings .....	3
1.5	Recommended Operating Conditions .....	3
2	Test Summary .....	5
2.1	Definitions .....	5
2.2	Safety .....	5
2.3	Quality .....	5
2.4	Safety Apparel .....	5
2.5	Equipment .....	5
2.6	Equipment Setup .....	6
2.7	Procedure .....	7
3	PCB Layout Guideline .....	9
4	Bill of Materials, Board Layout, and Schematic .....	10
4.1	Bill of Materials .....	10
4.2	Board Layout .....	12
4.3	Schematic .....	18

## **List of Figures**

1	Original Test Setup for HPA610A (bq24170EVM) .....	6
2	Top Assembly .....	12
3	Top Layer .....	13
4	Second Layer .....	14
5	Third Layer .....	15
6	Bottom Layer .....	16
7	Bottom Assembly .....	17
8	bq24170EVM Schematic .....	18

## **List of Tables**

1	I/O Description .....	2
2	Control and Key Parameters Settings .....	3
3	Recommended Operating Conditions .....	3
4	Bill of Materials .....	10

## 1 Introduction

### 1.1 EVM Features

- Evaluation module for bq24170
- Stand-alone synchronous switch-mode, battery-charge controller
- Integrated N-MOSFETs and power path selector
- CELL pin setting up to 12.6-V battery voltage; 1, 2, or 3 cells with 4.2 V/cell
- Input operating range: 4.5 V–16 V
- LED indication for charge status
- Test points for key signals available for testing purposes; easy probe hook-up.
- Jumpers available; easy-to-change setting

### 1.2 General Description

The bq24170 is highly integrated stand-alone Li-ion and Li-polymer switch-mode battery charge controllers with two integrated N-channel power MOSFETs and power path selector gate driver. It offers a constant-frequency synchronous PWM controller with high accuracy regulation of input current, charge current and voltage. It also provides battery detection, pre-conditioning, charge termination, and charge status monitoring.

The bq24170 automatically enters a low-quiescent current sleep mode when the input voltage falls below the battery voltage. The bq24170 charges one, two or three cells (selected by CELL pin), supporting up to a 4-A charge current. The bq24170 is available in a 24-pin, 3.5 x 5.5 mm<sup>2</sup>, thin QFN package.

For details, see the bq24170 data sheet ([SLUSAD2](#)).

### 1.3 I/O Description

**Table 1. I/O Description**

Jack	Description
J1–VIN	Positive input
J1–PGND	Negative input
J2–VSY	Connected to system
J2–VBAT	Connected to charger output
J2–PGND	Ground
J2–TS_EXT	Temperature qualification voltage Input

## 1.4 Control and Key Parameters Settings

**Table 2. Control and Key Parameters Settings**

Jack	Description	Factory Setting
JP1	Select external TS input or internal valid TS setting 1-2 : External TS input 2-3 : Internal valid TS setting	Jumper ON 1-2 (external TS)
JP2	The pullup power source supplies the LEDs when JP2 is ON. LED has no power source when JP2 is OFF.	Jumper ON (LED power available)
JP3	TTC setting 2-3 : Connect TTC to VREF to enable termination and disable timer 1-2 : Connect TTC to GND to disable termination and disable timer OPEN : Enable timer and termination	Jumper OPEN (enable timer and termination)
JP4	Charger enable/disable setting. ISET is pulled to GND and the charger is disabled when JP4 OPEN; charger is enabled when JP4 is ON.	Jumper OPEN (disable charger)
JP5	CELL selection 1-2 : CELL-GND, 1CELL 2-3 : CELL-VREF, 3CELL OPEN: CELL- FLOAT, 2CELL	Jumper ON 1-2 (1 CELL) -001 Jumper ON 2-3 (3 CELL) -002

## 1.5 Recommended Operating Conditions

**Table 3. Recommended Operating Conditions**

Symbol	Description	Min	Typ	Max	Unit	Notes
Supply voltage, $V_{BUS}$	Input voltage	4.5		8	V	001
Supply voltage, $V_{BUS}$	Input voltage	6		18	V	002
Battery voltage, $V_{BAT}$	Voltage applied at VBAT terminal of J2	2.1		4.2	V	001
Battery voltage, $V_{BAT}$	Voltage applied at VBAT terminal of J2	2.1		12.6	V	002
Supply current	Maximum input current	0		8	A	
Charge current, $I_{CHRG}$	Battery charge current	0	2	4	A	
Operating junction temperature range, $T_J$		0		125	°C	

The bq2410 EVM board requires a regulated supply approximately 1 V minimum above the regulated voltage of the battery pack to a maximum input voltage of 16 Vdc. The bq24170 uses the CELL pin to select the number of cells with a fixed 4.2 V/cell. Connecting CELL to AGND gives a 1-cell configuration, a floating CELL pin gives a 2-cell configuration, and connecting to VREF gives a 3-cell configuration. The CELL pin adjusts the internal resistor voltage divider from the BAT pin to AGND pin for voltage feedback and regulate to internal 2.1-V voltage reference.

CELL Pin	Voltage Regulation
AGND	4.2V
Floating	8.4V
VREF	12.6V

For Note 001, the BAT voltage is set to 4.2 V and for Note 002, the BAT voltage is set to 12.6 V.

The ISET input sets the maximum charging current. Battery current is sensed by current sensing resistor  $R_{SR}$  connected between SRP and SRN. The full-scale differential voltage between SRP and SRN is 40 mV maximum. The equation for charge current is:

$$I_{CHARGE} = \frac{V_{ISET}}{20 \times R15} \quad (1)$$

For bq24170, the precharge current is set as 1/10 of the fast-charge rate set by ISET voltage, according to the formula

$$I_{\text{PRECHARGE}} = \frac{V_{\text{ISET}}}{200 \times R15} \quad (2)$$

The default setting is 2 Adc for fast-charge current and 0.2 Adc for precharge current.

In the bq24170, once the voltage on OVPSET is above the 1.6-V ACOV threshold or below the 0.5-V ACUV threshold, the charge is disabled, and the battery is switched to the system instead of the adapter.

$$V_{\text{ACUV}} = 0.5 \text{ V} \times \left( 1 + \frac{R6}{R9} \right) \quad (3)$$

For Note 001, ACUV = 2.51 V; for Note 002, ACUV = 5.87 V.

$$V_{\text{ACOV}} = 1.6 \text{ V} \times \left( 1 + \frac{R6}{R9} \right) \quad (4)$$

For Note 001, ACOV = 8.03 V; for Note 002, ACOV = 18.80 V.

Similar to setting battery regulation current, the adapter current is set by the voltage on ACSET pin using the following equation:

$$I_{\text{DPM}} = \frac{V_{\text{ACSET}}}{20 \times R2} \quad (5)$$

The default setting on the EVM is 2 Adc (Note 001), 4 Adc (Note 002) for adapter current regulation.

## 2 Test Summary

### 2.1 Definitions

This procedure details how to configure the HPA610A evaluation board. On the test procedure the following naming conventions are followed.

VXXX :	External voltage supply name (VIN, VBAT, VTS)
LOADW:	External load name (LOADR, LOADI)
V(TPyyy):	Voltage at internal test point TPyyy. For example, V(TP1) means the voltage at TP1.
V(Jxx):	Voltage at jack terminal Jxx.
V(TP(XXX)):	Voltage at test point XXX. For example, V(ACSET) means the voltage at the test point which is marked as ACSET.
V(XXX, YYY):	Voltage across point XXX and YYY.
I(JXX(YYY)):	Current going out from the YYY terminal of jack XX.
Jxx(BBB):	Terminal or pin BBB of jack xx
Jxx ON :	Internal jumper Jxx terminals are shorted
Jxx OFF:	Internal jumper Jxx terminals are open
Jxx (-YY-) ON:	Internal jumper Jxx adjacent terminals marked as YY are shorted
Measure:→A,B	Check specified parameters A, B. If measured values are not within specified limits, the unit under test has failed.
Observe: →A,B	Observe if A, B occur. If they do not occur, the unit under test has failed.

Assembly drawings have location for jumpers, test points, and individual components.

### 2.2 Safety

1. Safety Glasses are to be worn.
2. This test must be performed by qualified personnel who are trained in electronics theory and understand the risks and hazards of the assembly to be tested.
3. ESD precautions must be followed while handling electronic assemblies and performing this test.
4. Precautions must be observed to avoid touching areas of the assembly that may get hot or present a shock hazard during testing.

### 2.3 Quality

1. Test data can be made available on request from Texas Instruments.

### 2.4 Safety Apparel

1. Electrostatic smock
2. Electrostatic gloves or finger cots
3. Safety glasses
4. Ground ESD wrist strap.

### 2.5 Equipment

#### 2.5.1 Power Supplies

Power Supply #1 (PS#1): a power supply capable of supplying 30 V at 5 A is required.

### 2.5.2 Loads

LOAD#1 A 30-V (or greater), 5-A (or greater) electronic load that can operate at constant current and constant voltage mode.

LOAD#2: An HP 6060B 3-V to 60-V/0-A to 60-A, 300-W system dc electronic load or equivalent.

### 2.5.3 Meters

Seven Fluke 75 multimeters (equivalent or better) or four equivalent voltage meters and three equivalent current meters.

The current meters must be capable of measuring 5-A+ current.

## 2.6 Equipment Setup

1. Set the Power Supply #1 (PS#1) for 6-V  $\pm$ 200-mVdc (001), or 16-V  $\pm$ 0.200-mV (002), 4.5-A  $\pm$ 0.1-A current limit, and then turn off supply.
2. Connect the output of PS#1 in series with a current meter (multimeter) to J1 (VIN, PGND).
3. Connect a voltage meter across J1 (VIN, PGND).
4. Connect Load#1 in series with a current meter to J2 (VBAT, PGND). Turn off Load#1.
5. Connect Load#2 in series with a current meter to J2 (VSYS, PGND). Turn off Load#2.
6. Connect a voltage meter across J2 (VBAT, PGND).
7. Connect a voltage meter across J2 (VSYS, PGND).
8. Check all jumper shunts. JP1: connect 2-3 (External TS); JP2: ON; JP3: OPEN; JP4: OPEN. JP5: connect 1-2 for 001 and connect 2-3 for 002.

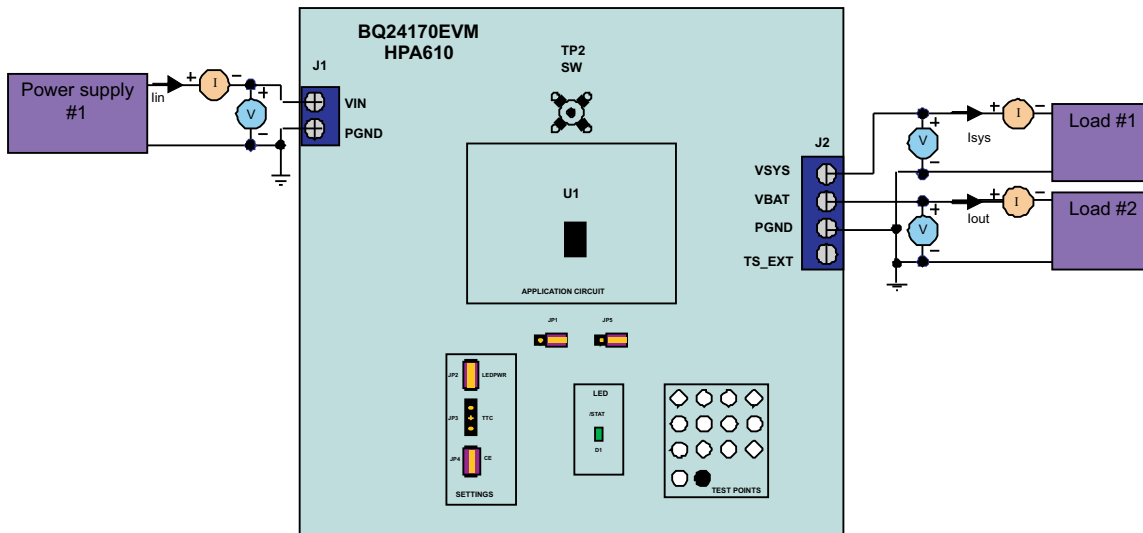

Figure 1. Original Test Setup for HPA610A (bq24710EVM)

## 2.7 Procedure

Disconnect the load and power supply. Use diode-function of multimeter to check the resistance between J1-VIN and J2-VSYS. Pass only if both OPEN for bi-direction (positive J1-VIN and negative on J2-VSYS; negative J1-VIN and positive on J2-VSYS).

### 2.7.1 Power Supply and VREF

Make sure that [Section 2.6](#) steps are followed.

Disconnect LOAD#1#2. Turn on PS#1 (6 V for 001 and 16 V for 002).

*Measure* → V(J2(VSYS)) = 6 V ±500 mV (001)

V(J2(VSYS)) = 16 V ±500 mV (002)

*Measure* → V(J2(VBAT)) = 0.5 V ±500 mV

*Measure* → V(TP(VREF)) = 3.3 V ±200 mV

*Measure* → V(TP(REGN)) = 0.5 V ±500 mV

### 2.7.2 Charger Enable and Battery Detection

Connect 2-3 of JP1 (Internal TS); short JP4 (Charger Enable)

*Measure* → V(TP(VREF)) = 3.3 V ±200 mV

*Measure* → V(TP(REGN)) = 6 V ±200 mV

*Observe* → V(J2(VBAT)) = 4.2 V ±200 mV (001)

V(J2(VBAT)) = 12.6 V ±200 mV (002)

*Observe* → D1 (/STAT) BLINK

### 2.7.3 Charge Current/Voltage Regulation and Battery Temperature Qualification

Reconnect LOAD#2, and turn on. Use the constant voltage mode. Set the output voltage to 2.5 V for 001 and 8 V for 002.

*Measure* → I(J2(VBAT)) = 0.2 A ±100 mA

*Observe* → D1 (/STAT) ON

Increase the voltage of LOAD#2 to 3.5 V for 001 and 10.5 V for 002.

*Measure* → I(J2(VBAT)) = 2 A ±200 mA

*Observe* → D1 (/STAT) ON

Open 2-3 of JP1 (External TS)

*Measure* → I(J2(VBAT)) = 0 A ±100 mA

*Observe* → D1 (/STAT) BLINK

Connect 2-3 of JP1 (Internal TS)

*Measure* → I(J2(VBAT)) = 2 A ±200 mA

*Observe* → D1 (/STAT) ON

### 2.7.4 Charger Termination and Recharge

Increase the voltage of LOAD#2 slowly to approximately 4.2 V for Note 001 and 12.6 V for Note 002.

*Observe* → I(J2(VBAT)) decreases from 2 A while V(J2(VBAT)) becomes constant.

*Observe* → I(J2(VBAT)) drops to zero when LOAD#2 current is less than 0.2 A.

Decrease the voltage of LOAD#2 slowly to approximately 3.5 V for Note 001 and 10.5 V for Note 002.

*Measure* →  $I(J2(VBAT)) = 2\text{ A} \pm 200\text{ mA}$ .

*Observe* → D1 (/STAT) ON.

### 2.7.5 OVP - Input Overvoltage Protection

Increase the voltage of PS#1 to 9 V for Note 001 or 20 V for Note 002.

*Measure* →  $I(J1(VIN)) = 0\text{ A} \pm 200\text{ mA}$ .

*Observe* → D1 (/STAT) BLINK.

### 2.7.6 DPM - Input Current Regulation

Connect the output of the Load#1 in series with a current meter (multimeter) to J2 (SYS, PGND). Ensure that a voltage meter is connected across J2 (SYS, PGND). Resume other status as in [Section 2.7.3](#).

Turn on the power of Load#1. Set the load current to 0.1 A (Note 001) or 1.5 A (Note 002). Increase the load current until  $I(J1(VIN)) = 2\text{ A}$  (Note 001) or 4 A (Note 002).

*Observe* →  $I(J2(VBAT))$  decreases from 2 A to 0 A and  $I(J1(VIN))$  and keeps 2 A (Note 001) or 4 A (Note 002) unchanged.

### 2.7.7 Test Complete

Turn off the power supply, and remove all connections from the unit under test (UUT).



### 3 PCB Layout Guideline

1. It is critical that the exposed thermal pad on the backside of the bq24170 package be soldered to the PCB ground. Ensure that sufficient thermal vias are right underneath the IC, connecting to the ground plane on the other layers.
2. The control stage and the power stage must be routed separately. At each layer, the signal ground and the power ground are connected only at the thermal pad.
3. Charge current sense resistor must be connected to SRP and SRN with a Kelvin contact. The area of this loop must be minimized. The decoupling capacitors for these pins must be placed as close to the IC as possible.
4. Input current sense resistor must be connected to ACP, ACN with a Kelvin contact. The area of this loop must be minimized. The decoupling capacitors for these pins should be placed as close to the IC as possible.
5. Decoupling capacitors for VREF, AVCC, and REGN must make the interconnections to the IC as short as possible.
6. Decoupling capacitors for BAT must be placed close to the corresponding IC pins, and make the interconnections to the IC as short as possible.
7. Decoupling capacitor(s) for the charger input must be placed close to SW and PGND.
8. Take the EVM layout for design reference.

## 4 Bill of Materials, Board Layout, and Schematic

### 4.1 Bill of Materials

**Table 4. Bill of Materials**

Count		RefDes	Value	Description	Size	Part Number	MFR
-001	-002						
4	4	C1, C7, C14, C15	10uF	Capacitor, Ceramic, 25V, X7R, 10%	1206	STD	STD
0	0	C2	Open				
1	1	C3	2.2uF	Capacitor, Ceramic, 25V, X7R, 10%	0805	STD	STD
1	1	C4	330pF	Capacitor, Ceramic, 50V, X7R, 10%	0603	STD	STD
2	2	C5, C18	0.1uF	Capacitor, Ceramic, 16V, X7R, 10%	0603	STD	STD
2	2	C6, C13	0.047uF	Capacitor, Ceramic, 50V, X7R, 10%	0603	STD	STD
3	3	C8, C16, C17	1.0uF	Capacitor, Ceramic, 25V, X7R, 10%	0805	STD	STD
1	1	C9	4700pF	Capacitor, Ceramic, 25V, X7R, 10%	0603	STD	STD
3	3	C10, C20, C24	0.1uF	Capacitor, Ceramic, 50V, X7R, 10%	0603	STD	STD
0	0	C11, C12, C21, C23	Open				
2	2	C22, C19	1.0uF	Capacitor, Ceramic, 16V, X7R, 20%	0805	STD	STD
1	1	C25	0.1uF	Capacitor, Ceramic, 50V, X7R, 10%	0603	STD	STD
1	1	C26	22pF	Capacitor, Ceramic, 50V, X7R, 10%	0603	STD	STD
1	1	D1	LTST-C190GKT	Diode, LED, Green, 2.1V, 20mA, 6mcd	0603	LTST-C190GKT	Lite On
1	1	D2	B220A-13-F	Diode, Schottky, 2A, 20V	SMA	B220A-13-F	Diodes In
0	1	D3	BAT54C	Diode, Dual Schottky, 200-mA, 30-V	SOT23	BAT54C	Vishay-Liteon
1	1	J1	ED120/2DS	Terminal Block, 2 pin, 15A, 5.1mm	0.40 x 0.35 inch	ED120/2DS	OST
1	1	J2	ED120/4DS	Terminal Block, 4 pin, 15A, 5.1mm	0.80 x 0.35 inch	ED120/4DS	OST
2	2	JP1, JP3	PEC03SAAN	Header, 3 pin, 100mil spacing	0.100 inch x 3	PEC03SAAN	Sullins
2	2	JP2, JP4	PEC02SAAN	Header, 2 pin, 100mil spacing	0.100 inch x 2	PEC02SAAN	Sullins
1	1	L1	3.3uH	Inductor, SMT, 5A, 55milliohm	0.204 x 0.216 inch	IHLP2020CZER3R3M01	Vishay
1	1	Q1	BSS138W	MOSFET, Nch, 30V, 0.5A, 700 milliohms	SOT323	BSS138W-7-F	Vishay
2	2	Q2, Q3	CSD17313Q2	Trans, Nch, 30V, 5A, 26milliohm	SON-6	CSD17313Q2	TI
1	1	Q4	CSD25401Q3	MOSFET, PChan, -20V, 60A, 8.7 mΩ	QFN3.3X3.3mm	CSD25401Q3	TI
1	1	Q5	2N7002DICT	MOSFET, N-ch, 60V, 115mA, 1.2 Ω	SOT23	2N7002DICT	Vishay-Liteon
1	1	R1	1.00M	Resistor, Chip, 1/16W, 5%	0603	STD	STD
1	0	R2	0.02 Ohm	Resistor, Metal Film, 1/2 watt, 1%	2010	WSL2010R0200FEA	Vishay
0	1		0.01 Ohm	Resistor, Metal Film, 1/2 watt, 1%	2010	WSL2010R0100FEA	Vishay
4	4	R3, R16, R20, R29	0	Resistor, Chip, 1/16W, 5%	0603	STD	STD
2	2	R4, R5	3.9	Resistor, Chip, 1/4W, 5%	1206	STD	STD
1	1	R6	402k	Resistor, Chip, 1/16W, 1%	0603	STD	STD
1	1	R7	499k	Resistor, Chip, 1/8W, 5%	0603	STD	STD
1	0	R8	100k	Resistor, Chip, 1/16W, 1%	0603	STD	STD
1	0	R9	100k	Resistor, Chip, 1/16W, 1%	0603	STD	STD
0	1		37.4k	Resistor, Chip, 1/16W, 1%	0603	STD	STD
1	0	R10	10k	Resistor, Chip, 1/16W, 5%	0603	STD	STD
0	1		1M	Resistor, Chip, 1/16W, 5%	0603	STD	STD
1	1	R11	1.00k	Resistor, Chip, 1/16W, 1%	0603	STD	STD
0	0	R12	Open			STD	STD
2	2	R13, R14	4.02k	Resistor, Chip, 1/16W, 5%	0603	STD	STD
1	1	R15	0.01	Resistor, Metal Film, 1/4 watt, 1%	1206	WSL1206R0100FEA	Vishay
1	1	R17	10	Resistor, Chip, 1/16W, 5%	0805	STD	STD

**Table 4. Bill of Materials (continued)**

Count		RefDes	Value	Description	Size	Part Number	MFR
-001	-002						
1	0	R19	10	Resistor, Chip, 1/16W, 5%	0805	STD	STD
1	1	R21	5.23k	Resistor, Chip, 1/16W, 1%	0603	STD	STD
0	1	R22	499k	Resistor, Chip, 1/16W, 1%	0603	STD	STD
1	0		0	Resistor, Chip, 1/16W, 5%	0603	STD	STD
1	1	R23	100	Resistor, Chip, 1/16W, 5%	0603	STD	STD
1	1	R24	30.1k	Resistor, Chip, 1/16W, 1%	0603	STD	STD
1	1	R25	3.01M	Resistor, Chip, 1/16W, 5%	0603	STD	STD
1	1	R26	10k	Resistor, Chip, 1/16W, 5%	0603	STD	STD
1	1	R27	4.99k	Resistor, Chip, 1/16W, 5%	0603	STD	STD
2	2	R28, R31	100k	Resistor, Chip, 1/16W, 1%	0603	STD	STD
1	1	R30	232k	Resistor, Chip, 1/16W, 1%	0603	STD	STD
2	2	R32, R18	32.4k	Resistor, Chip, 1/16W, 1%	0603	STD	STD
1	1	R33	0	Resistor, Chip, 1/16W, 1%	0603	STD	STD
1	0	R34	100k	Resistor, Chip, 1/16W, 1%	0603	STD	STD
1	1	R35	100k	Resistor, Chip, 1/16W, 1%	0603	STD	STD
0	0	TP1, TP3 - TP6	TP-SMALL	Test Point, 0.020 Hole	0.100 x 0.100 inch	N/A	N/A
1	1	TP2	131-5031-00	Adaptor, 3.5-mm probe clip	0.200 inch	131-4244-00 or 131-5031-00	Tektronix
13	13	TP7 - TP19	5002	Test Point, White, Thru Hole Color Keyed	0.100 x 0.100 inch	5002	Keystone
1	1	TP20	5001	Test Point, Black, Thru Hole Color Keyed	0.100 x 0.100 inch	5001	Keystone
1	1	U1	BQ24170RHL	IC, Power Path Selector Stand-alone Charger	VQFN	BQ24170RHL	TI
1	1	--		PCB, 2.65 In x 3.00 In x 0.062 In		HPA610A	Any
4	4			Bumper foot (install after final wash)	0.440 x 0.2	SJ-5303	3M
4	4			Shunt, 100-mil, Black	0.100	929950-00	3M
1	1	--		Label (See Note 5)	1.25 x 0.25 inch	THT-13-457-10	Brady
<p>Notes: 1. These assemblies are ESD sensitive, ESD precautions shall be observed.</p> <p>2. These assemblies must be clean and free from flux and all contaminants. Use of no clean flux is not acceptable.</p> <p>3. These assemblies must comply with workmanship standards IPC-A-610 Class 2.</p> <p>4. Ref designators marked with an asterisk (***) cannot be substituted. All other components can be substituted with equivalent MFG's components.</p> <p>5. Install label after final wash. Text shall be 8 pt font. Text shall be per Table 1.</p>							

## 4.2 Board Layout

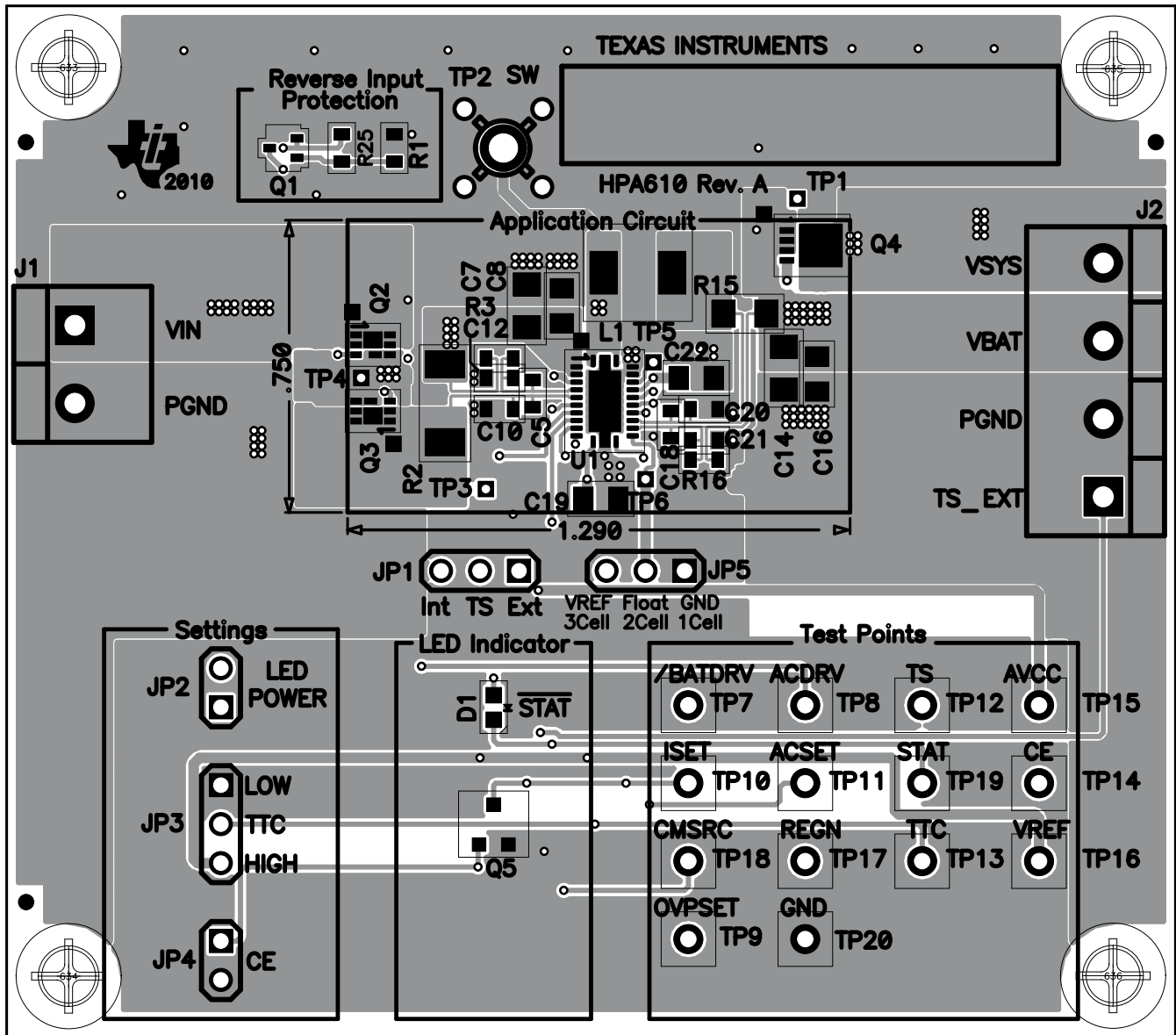

Figure 2. Top Assembly

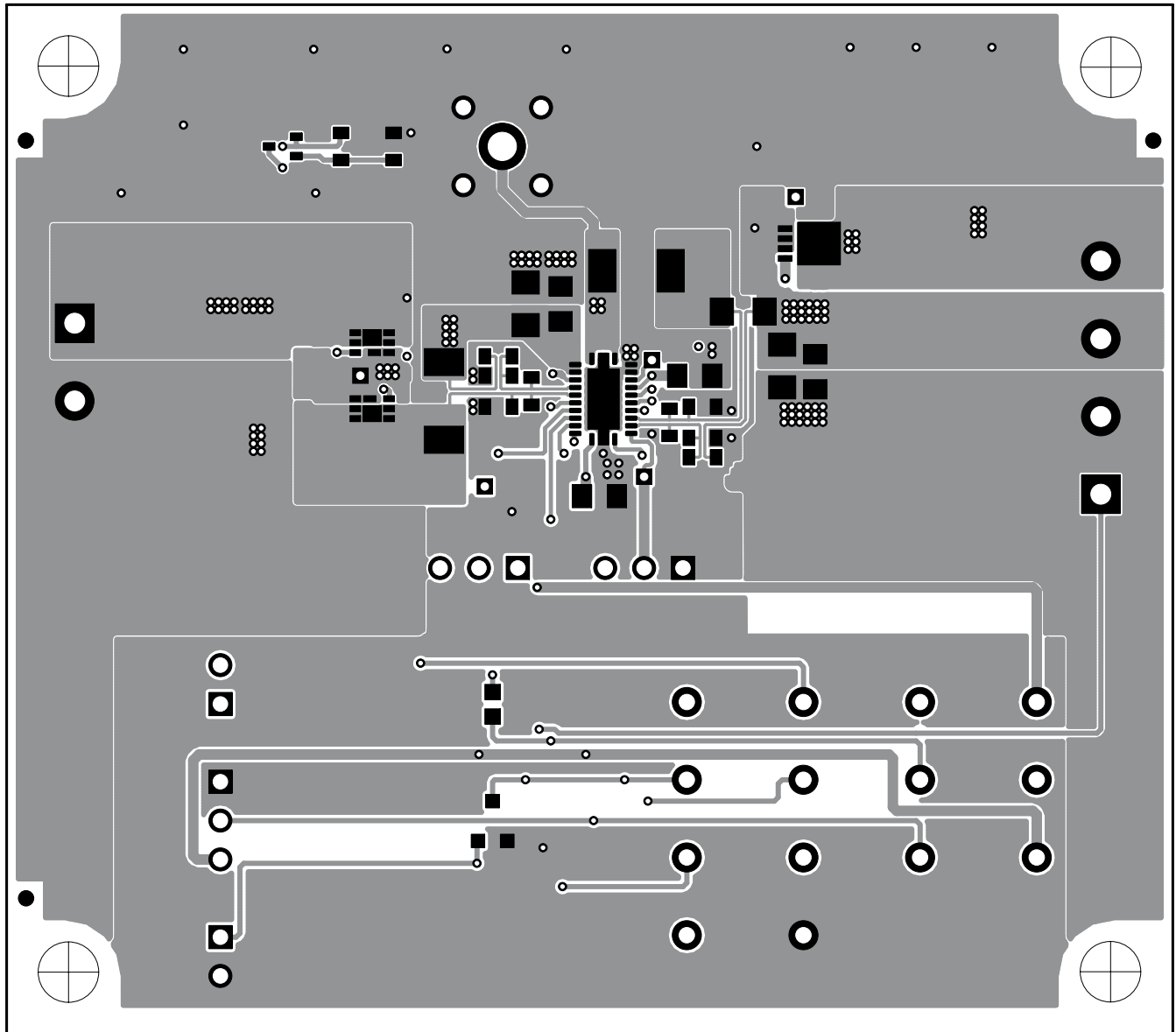

Figure 3. Top Layer

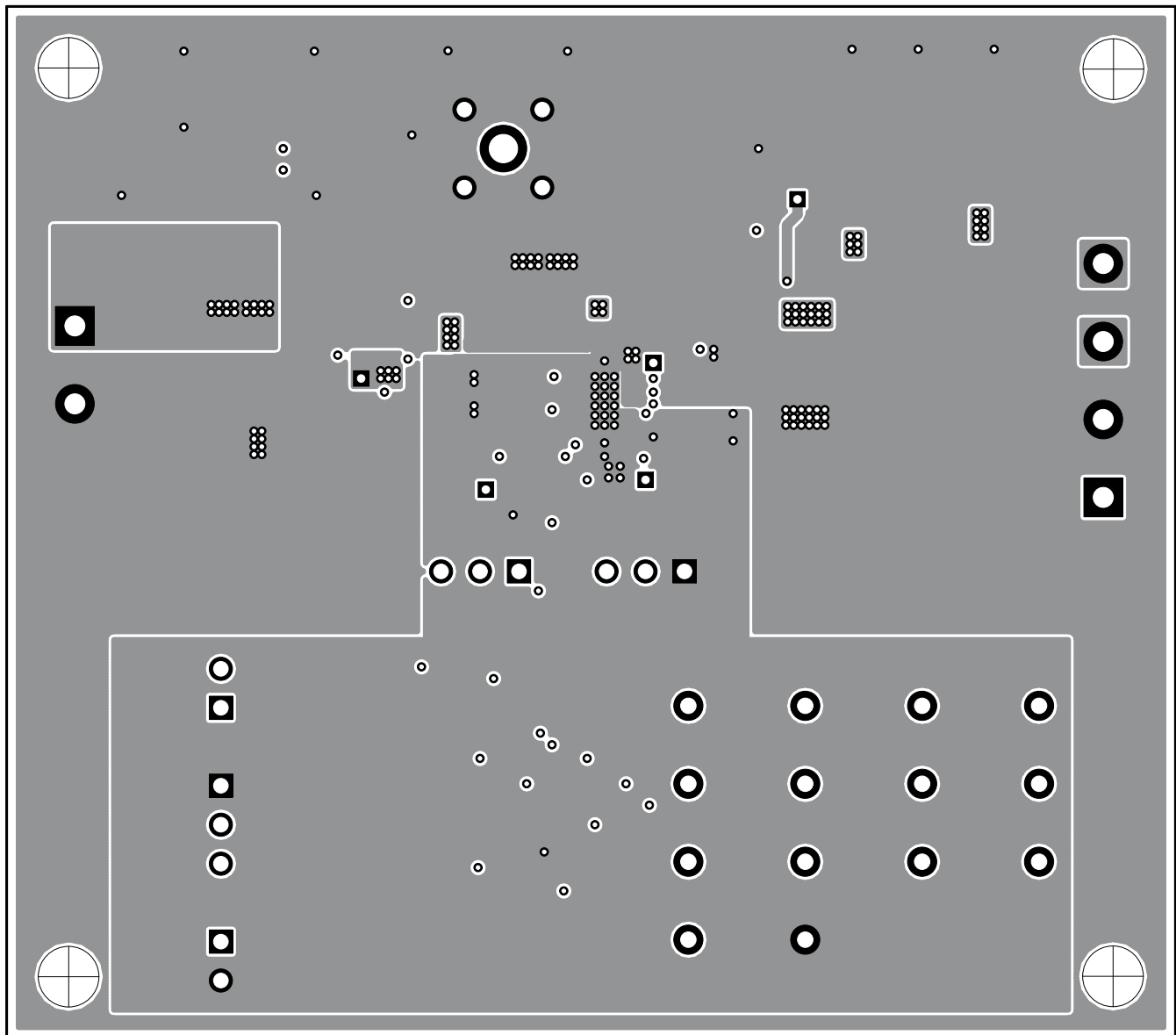

Figure 4. Second Layer

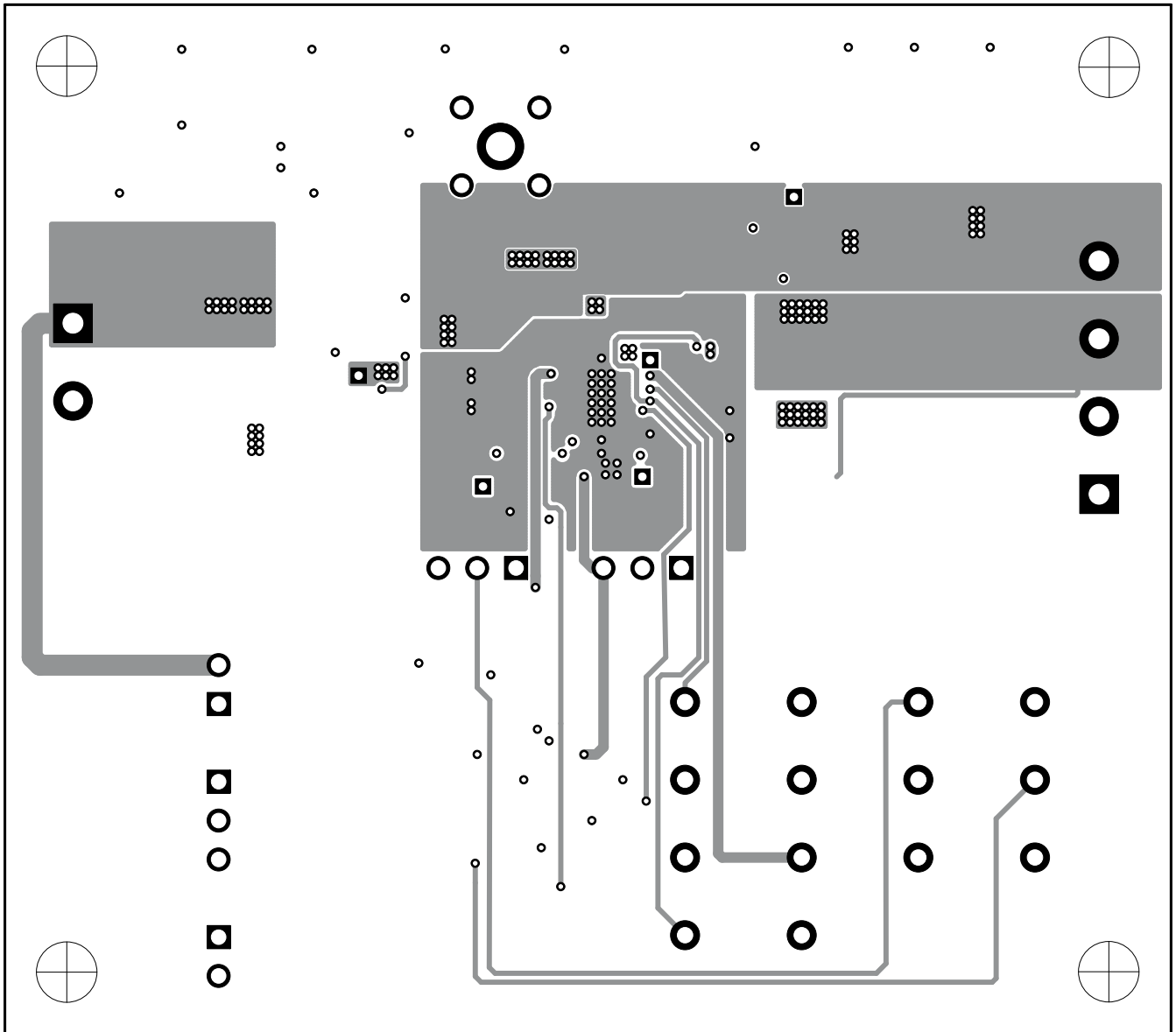
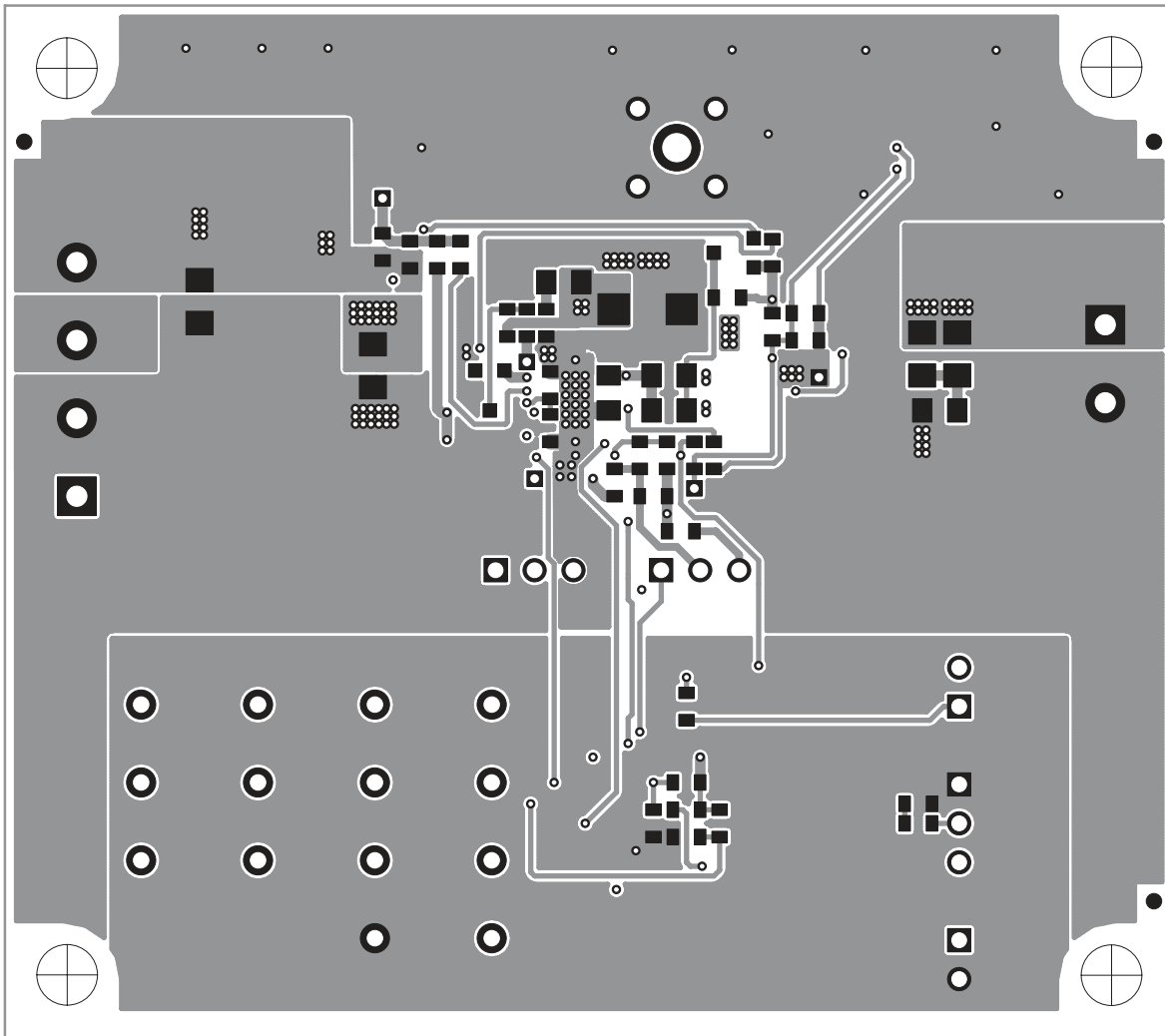

Figure 5. Third Layer



**Figure 6. Bottom Layer**



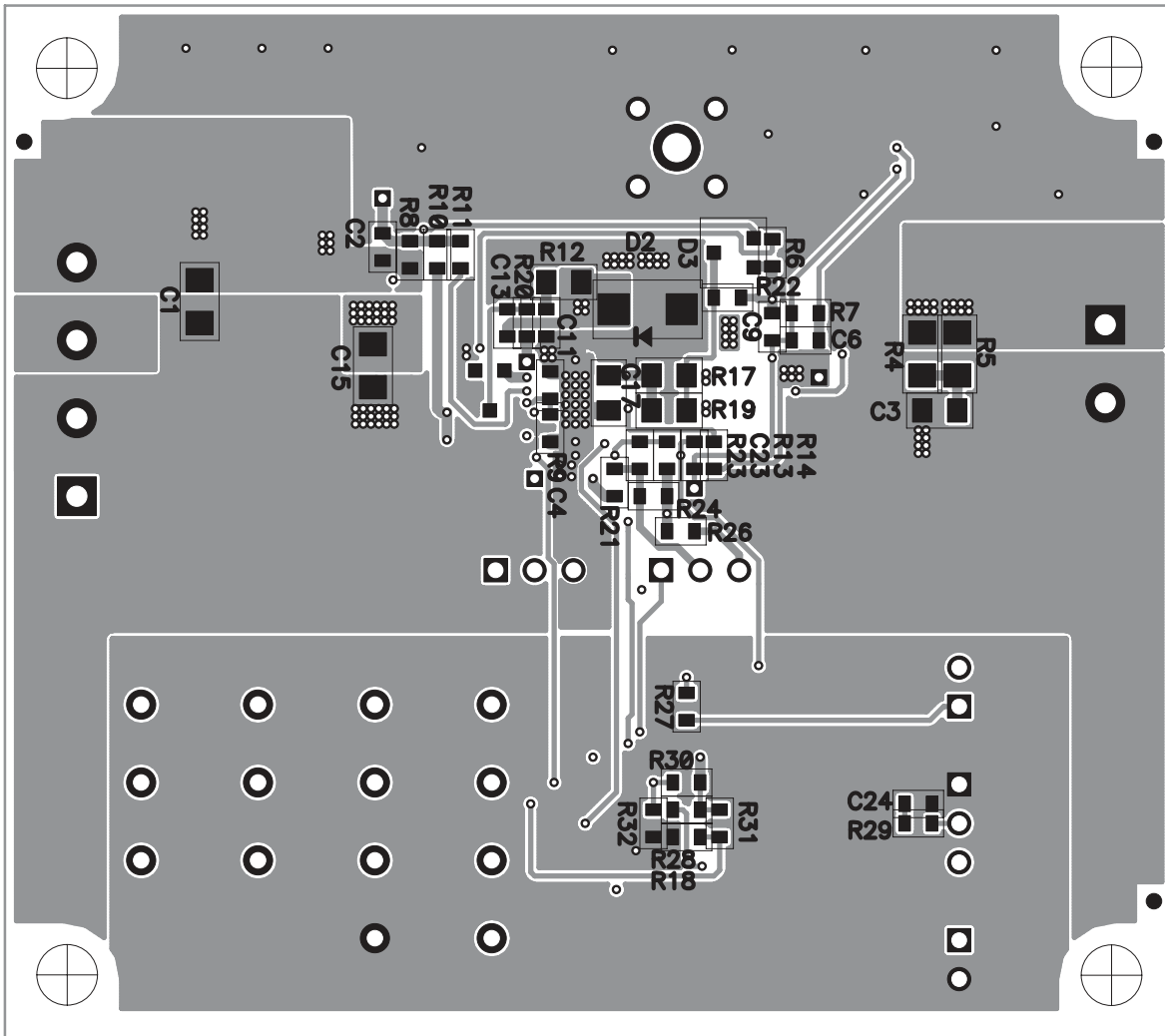

Figure 7. Bottom Assembly

4.3 Schematic

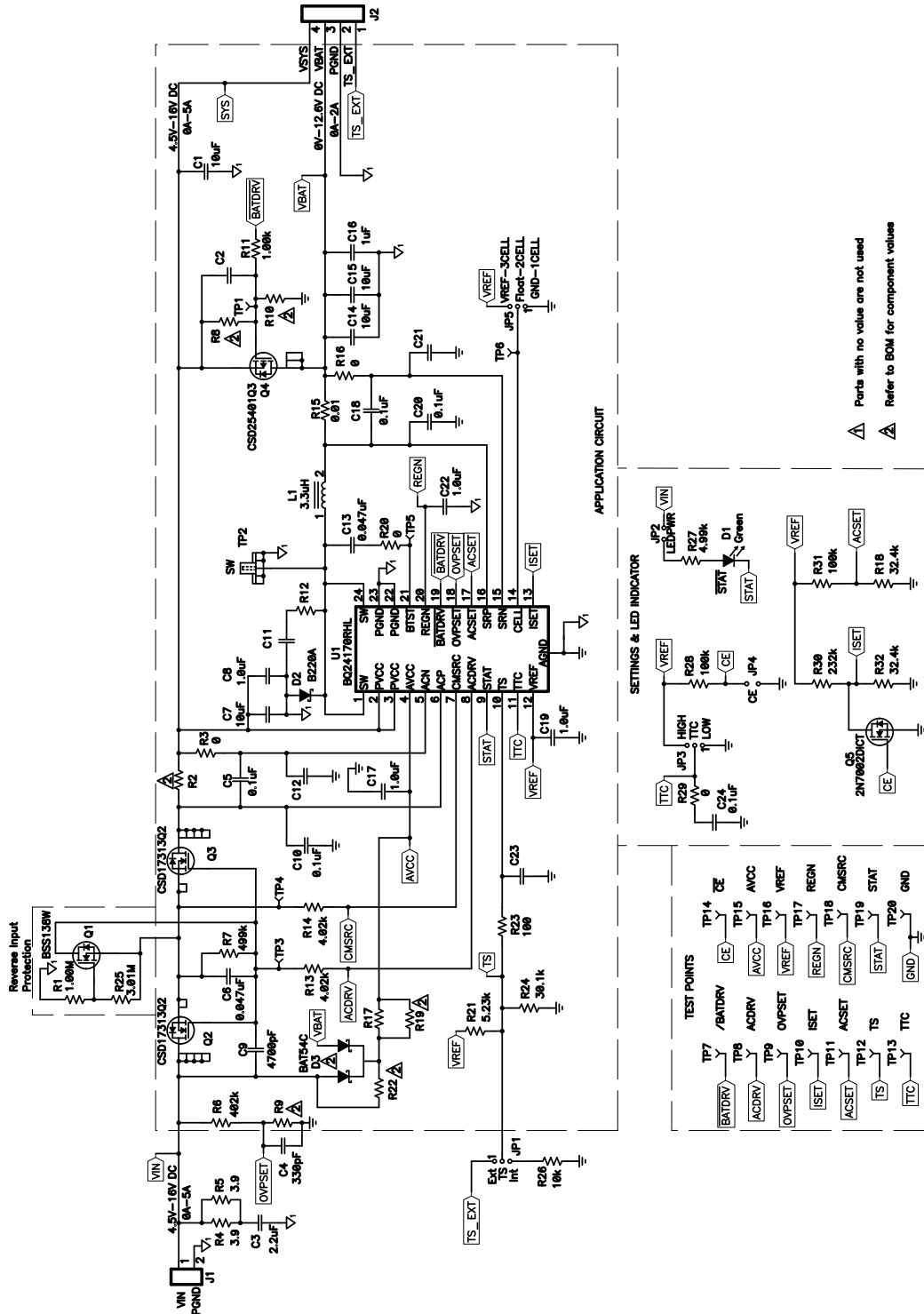

Figure 8. bq24170EVM Schematic

## Evaluation Board/Kit Important Notice

Texas Instruments (TI) provides the enclosed product(s) under the following conditions:

This evaluation board/kit is intended for use for **ENGINEERING DEVELOPMENT, DEMONSTRATION, OR EVALUATION PURPOSES ONLY** and is not considered by TI to be a finished end-product fit for general consumer use. Persons handling the product(s) must have electronics training and observe good engineering practice standards. As such, the goods being provided are not intended to be complete in terms of required design-, marketing-, and/or manufacturing-related protective considerations, including product safety and environmental measures typically found in end products that incorporate such semiconductor components or circuit boards. This evaluation board/kit does not fall within the scope of the European Union directives regarding electromagnetic compatibility, restricted substances (RoHS), recycling (WEEE), FCC, CE or UL, and therefore may not meet the technical requirements of these directives or other related directives.

Should this evaluation board/kit not meet the specifications indicated in the User's Guide, the board/kit may be returned within 30 days from the date of delivery for a full refund. **THE FOREGOING WARRANTY IS THE EXCLUSIVE WARRANTY MADE BY SELLER TO BUYER AND IS IN LIEU OF ALL OTHER WARRANTIES, EXPRESSED, IMPLIED, OR STATUTORY, INCLUDING ANY WARRANTY OF MERCHANTABILITY OR FITNESS FOR ANY PARTICULAR PURPOSE.**

The user assumes all responsibility and liability for proper and safe handling of the goods. Further, the user indemnifies TI from all claims arising from the handling or use of the goods. Due to the open construction of the product, it is the user's responsibility to take any and all appropriate precautions with regard to electrostatic discharge.

**EXCEPT TO THE EXTENT OF THE INDEMNITY SET FORTH ABOVE, NEITHER PARTY SHALL BE LIABLE TO THE OTHER FOR ANY INDIRECT, SPECIAL, INCIDENTAL, OR CONSEQUENTIAL DAMAGES.**

TI currently deals with a variety of customers for products, and therefore our arrangement with the user **is not exclusive.**

TI assumes **no liability for applications assistance, customer product design, software performance, or infringement of patents or services described herein.**

Please read the User's Guide and, specifically, the Warnings and Restrictions notice in the User's Guide prior to handling the product. This notice contains important safety information about temperatures and voltages. For additional information on TI's environmental and/or safety programs, please contact the TI application engineer or visit [www.ti.com/esh](http://www.ti.com/esh).

No license is granted under any patent right or other intellectual property right of TI covering or relating to any machine, process, or combination in which such TI products or services might be or are used.

## FCC Warning

This evaluation board/kit is intended for use for **ENGINEERING DEVELOPMENT, DEMONSTRATION, OR EVALUATION PURPOSES ONLY** and is not considered by TI to be a finished end-product fit for general consumer use. It generates, uses, and can radiate radio frequency energy and has not been tested for compliance with the limits of computing devices pursuant to part 15 of FCC rules, which are designed to provide reasonable protection against radio frequency interference. Operation of this equipment in other environments may cause interference with radio communications, in which case the user at his own expense will be required to take whatever measures may be required to correct this interference.

## EVM Warnings and Restrictions

It is important to operate this EVM within the input voltage range of 0 V to 20 V and the output voltage range of 0 V to 12.6 V .

Exceeding the specified input range may cause unexpected operation and/or irreversible damage to the EVM. If there are questions concerning the input range, please contact a TI field representative prior to connecting the input power.

Applying loads outside of the specified output range may result in unintended operation and/or possible permanent damage to the EVM. Please consult the EVM User's Guide prior to connecting any load to the EVM output. If there is uncertainty as to the load specification, please contact a TI field representative.

During normal operation, some circuit components may have case temperatures greater than 85° C. The EVM is designed to operate properly with certain components above 85° C as long as the input and output ranges are maintained. These components include but are not limited to linear regulators, switching transistors, pass transistors, and current sense resistors. These types of devices can be identified using the EVM schematic located in the EVM User's Guide. When placing measurement probes near these devices during operation, please be aware that these devices may be very warm to the touch.

Mailing Address: Texas Instruments, Post Office Box 655303, Dallas, Texas 75265  
Copyright © 2010, Texas Instruments Incorporated

## IMPORTANT NOTICE

Texas Instruments Incorporated and its subsidiaries (TI) reserve the right to make corrections, modifications, enhancements, improvements, and other changes to its products and services at any time and to discontinue any product or service without notice. Customers should obtain the latest relevant information before placing orders and should verify that such information is current and complete. All products are sold subject to TI's terms and conditions of sale supplied at the time of order acknowledgment.

TI warrants performance of its hardware products to the specifications applicable at the time of sale in accordance with TI's standard warranty. Testing and other quality control techniques are used to the extent TI deems necessary to support this warranty. Except where mandated by government requirements, testing of all parameters of each product is not necessarily performed.

TI assumes no liability for applications assistance or customer product design. Customers are responsible for their products and applications using TI components. To minimize the risks associated with customer products and applications, customers should provide adequate design and operating safeguards.

TI does not warrant or represent that any license, either express or implied, is granted under any TI patent right, copyright, mask work right, or other TI intellectual property right relating to any combination, machine, or process in which TI products or services are used. Information published by TI regarding third-party products or services does not constitute a license from TI to use such products or services or a warranty or endorsement thereof. Use of such information may require a license from a third party under the patents or other intellectual property of the third party, or a license from TI under the patents or other intellectual property of TI.

Reproduction of TI information in TI data books or data sheets is permissible only if reproduction is without alteration and is accompanied by all associated warranties, conditions, limitations, and notices. Reproduction of this information with alteration is an unfair and deceptive business practice. TI is not responsible or liable for such altered documentation. Information of third parties may be subject to additional restrictions.

Resale of TI products or services with statements different from or beyond the parameters stated by TI for that product or service voids all express and any implied warranties for the associated TI product or service and is an unfair and deceptive business practice. TI is not responsible or liable for any such statements.

TI products are not authorized for use in safety-critical applications (such as life support) where a failure of the TI product would reasonably be expected to cause severe personal injury or death, unless officers of the parties have executed an agreement specifically governing such use. Buyers represent that they have all necessary expertise in the safety and regulatory ramifications of their applications, and acknowledge and agree that they are solely responsible for all legal, regulatory and safety-related requirements concerning their products and any use of TI products in such safety-critical applications, notwithstanding any applications-related information or support that may be provided by TI. Further, Buyers must fully indemnify TI and its representatives against any damages arising out of the use of TI products in such safety-critical applications.

TI products are neither designed nor intended for use in military/aerospace applications or environments unless the TI products are specifically designated by TI as military-grade or "enhanced plastic." Only products designated by TI as military-grade meet military specifications. Buyers acknowledge and agree that any such use of TI products which TI has not designated as military-grade is solely at the Buyer's risk, and that they are solely responsible for compliance with all legal and regulatory requirements in connection with such use.

TI products are neither designed nor intended for use in automotive applications or environments unless the specific TI products are designated by TI as compliant with ISO/TS 16949 requirements. Buyers acknowledge and agree that, if they use any non-designated products in automotive applications, TI will not be responsible for any failure to meet such requirements.

Following are URLs where you can obtain information on other Texas Instruments products and application solutions:

<b>Products</b>		<b>Applications</b>	
Amplifiers	<a href="http://amplifier.ti.com">amplifier.ti.com</a>	Audio	<a href="http://www.ti.com/audio">www.ti.com/audio</a>
Data Converters	<a href="http://dataconverter.ti.com">dataconverter.ti.com</a>	Automotive	<a href="http://www.ti.com/automotive">www.ti.com/automotive</a>
DLP® Products	<a href="http://www.dlp.com">www.dlp.com</a>	Communications and Telecom	<a href="http://www.ti.com/communications">www.ti.com/communications</a>
DSP	<a href="http://dsp.ti.com">dsp.ti.com</a>	Computers and Peripherals	<a href="http://www.ti.com/computers">www.ti.com/computers</a>
Clocks and Timers	<a href="http://www.ti.com/clocks">www.ti.com/clocks</a>	Consumer Electronics	<a href="http://www.ti.com/consumer-apps">www.ti.com/consumer-apps</a>
Interface	<a href="http://interface.ti.com">interface.ti.com</a>	Energy	<a href="http://www.ti.com/energy">www.ti.com/energy</a>
Logic	<a href="http://logic.ti.com">logic.ti.com</a>	Industrial	<a href="http://www.ti.com/industrial">www.ti.com/industrial</a>
Power Mgmt	<a href="http://power.ti.com">power.ti.com</a>	Medical	<a href="http://www.ti.com/medical">www.ti.com/medical</a>
Microcontrollers	<a href="http://microcontroller.ti.com">microcontroller.ti.com</a>	Security	<a href="http://www.ti.com/security">www.ti.com/security</a>
RFID	<a href="http://www.ti-rfid.com">www.ti-rfid.com</a>	Space, Avionics & Defense	<a href="http://www.ti.com/space-avionics-defense">www.ti.com/space-avionics-defense</a>
RF/IF and ZigBee® Solutions	<a href="http://www.ti.com/lprf">www.ti.com/lprf</a>	Video and Imaging	<a href="http://www.ti.com/video">www.ti.com/video</a>
		Wireless	<a href="http://www.ti.com/wireless-apps">www.ti.com/wireless-apps</a>

Mailing Address: Texas Instruments, Post Office Box 655303, Dallas, Texas 75265  
Copyright © 2010, Texas Instruments Incorporated