

### DESCRIPTION

The EVM3680-RE-00A is used for demonstrating the performance of MPS' MPM3680, a 6A step-down power module with built-in power MOSFETs and power inductor.

High power efficiency over a wide load range is achieved by scaling down the switching frequency at light load to reduce the switching related loss by constant on time control. Over-Current-Protection, Over-Voltage Protection, Under-Voltage Protection, and thermal shutdown provide reliable operation.

MPM3680 is available in QFN 12x12x4mm package.

### ELECTRICAL SPECIFICATION

| Parameter      | Symbol    | Value         | Units |
|----------------|-----------|---------------|-------|
| Input Voltage  | $V_{IN}$  | 8–18          | V     |
| Output Voltage | $V_{OUT}$ | 1/1.2/1.5/1.8 | V     |
| Output Current | $I_{OUT}$ | 6             | A     |

### FEATURES

- Complete 6A DC-to-DC Solution
- Wide Input Voltage Range from 2.5V:
  - 2.5V to 18V with External 5V Bias
  - 4.5V to 18V with Internal Bias
- 1% Reference Voltage Over 0°C to 70°C Junction Temperature Range
- Adaptive COT Control for Ultrafast Transient Response
- Programmable Switching Frequency from 200KHz to 1MHz
- Support Pre-Bias Start Up
- Programmable Soft-Start Time with Default 3ms
- Non-latch OCP, OVP and Thermal Shutdown
- Output Adjustable from 0.65V to 5V
- 12 x 12 x 4 (mm) QFN package

### APPLICATIONS

- Telecom and Networking Systems
- Base Stations
- Servers
- Personal Video Recorders
- Flat Panel Television and Monitors
- Distributed Power Systems

All MPS parts are lead-free, halogen free, and adhere to the RoHS directive. For MPS green status, please visit MPS website under Quality Assurance. "MPS" and "The Future of Analog IC Technology" are Registered Trademarks of Monolithic Power Systems, Inc.

## EVM3680-RE-00A EVALUATION BOARD



| Board Number   | MPS IC Number |
|----------------|---------------|
| EVM3680-RE-00A | MPM3680GRE    |

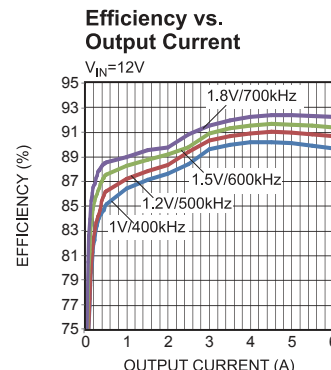

### EVALUATION BOARD SCHEMATIC

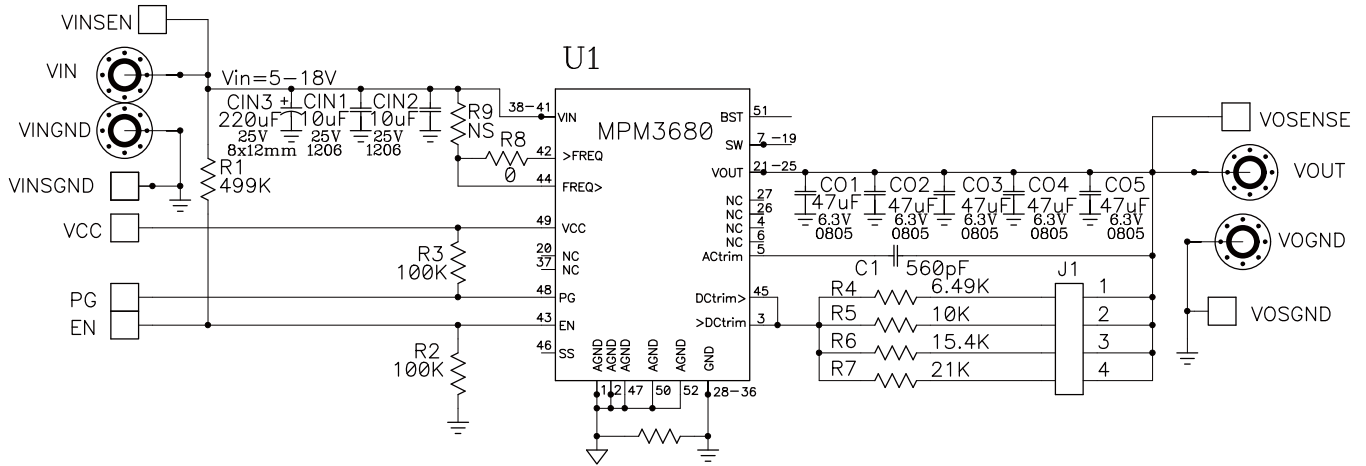

| J1   |      |      |      | VOUT |
|------|------|------|------|------|
| 1    | 2    | 3    | 4    | 1.0V |
| ON   | OPEN | OPEN | OPEN | 1.2V |
| OPEN | ON   | OPEN | OPEN | 1.5V |
| OPEN | OPEN | ON   | OPEN | 1.8V |

**EVM3680-RE-00A BILL OF MATERIALS**

| RefDes                  | Value   | Description                 | Package       | Manufacturer | Manufacturer P/N   |
|-------------------------|---------|-----------------------------|---------------|--------------|--------------------|
| C1                      | 560pF   | CAP, 25V, 5%, NP0           | CAP0603       | Murata       | GRM1885C1E561JA01D |
| CIN1, CIN2              | 10µF    | Capacitor, 25V, X7R, 10%    | CAP1206       | Murata       | GRM31CR71E106KA12L |
| CIN3                    | 220µF   | 220uF, 25V, 20%, 22mOhm ESR | SM8x12mm      | Nichicon     | PCV1E221MCL2GS     |
| CO1, CO2, CO3, CO4, CO5 | 47µF    | CAP, 4V, X5R, 20%           | CAP0805       | Murata       | GRM21BR60G476ME15L |
| R1                      | 499k    | Film Res., 1%               | 0603          | Yageo        | RC0603FR-07499KL   |
| R2, R3                  | 100k    | Film Res., 1%               | 0603          | Yageo        | RC0603FR-07100KL   |
| R4                      | 6.49k   | Film Res., 1%               | 0603          | Yageo        | RC0603FR-076K49L   |
| R5                      | 10k     | Film Res., 1%               | 0603          | Yageo        | RC0603FR-0710KL    |
| R6                      | 15.4k   | Film Res., 1%               | 0603          | Yageo        | RC0603FR-0715K4L   |
| R7                      | 21k     | Film Res., 1%               | 0603          | Yageo        | RC0603FR-0721KL    |
| R8                      | 0       | Film Res., 1%               | 0603          | Yageo        | RC0603FR-070RL     |
| R9                      | NS      | Film Res., 1%               | 0603          | Any          | Any                |
| U1                      | MPM3680 | 18V/6A Power Stage Module   | QFN57-12X12mm | MPS          | MPM3680GRE         |
| Miscellaneous           |         |                             |               |              |                    |
| Banana Jack             |         | Non-insulated Banana Jack   | 575-4         | Keystone     | 575-4              |
| J1                      |         | 2mm, 8-pin Dual Row Header  | 4x2x2mm       | Würth        | 620 008 211 21     |
| Jumper                  |         | 2mm Jumper                  | 2x3.5mm       | Würth        | 608 002 134 21     |
| Test Point              |         | 2.54mm Pitch, 9-pin Header  | 2.54mmx9      | Würth        | 613 009 111 21     |
| Test Point              |         | 2.54mm Pitch, 3-pin Header  | 2.54mmx3      | Würth        | 613 003 111 21     |

## EVB TEST RESULTS

Performance waveforms are tested on the evaluation board.

$V_{IN}=12V$ ,  $V_{OUT}=1.2V$ ,  $T_A = 25^{\circ}C$ , unless otherwise noted.

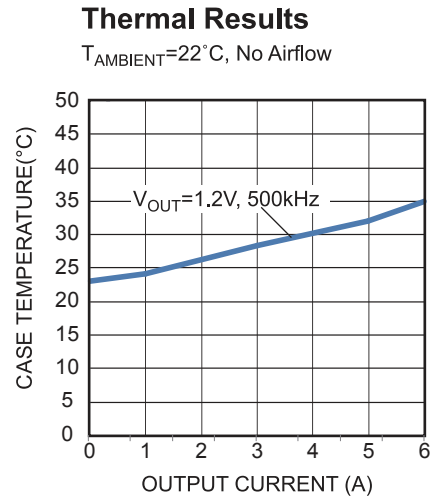
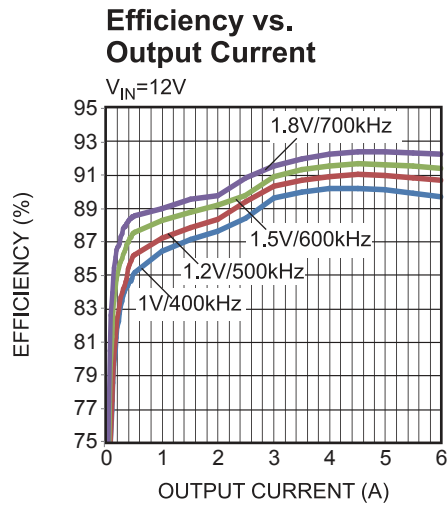

**EVB TEST RESULTS (continued)**

Performance waveforms are tested on the evaluation board.

 $V_{IN}=12V$ ,  $V_{OUT}=1.2V$ ,  $T_A = 25^{\circ}C$ , unless otherwise noted.

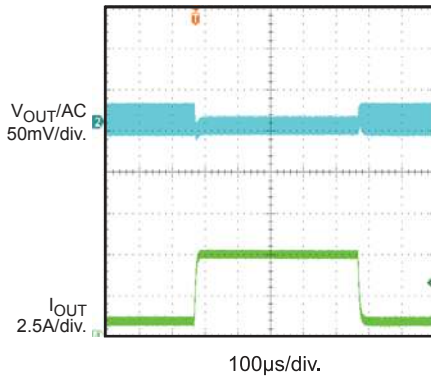
**Load Transient Response**
 $I_{OUT}=1\sim 5A @ 2.5A/\mu s$ 

**Power Up Through EN**

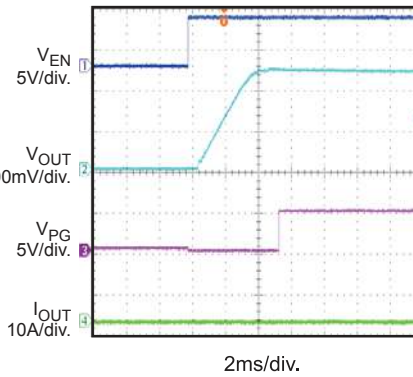
0A

**Power Up Through EN**

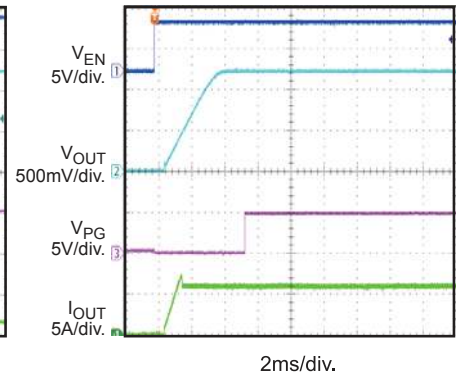
6A

**Power Up Through Input**

0A

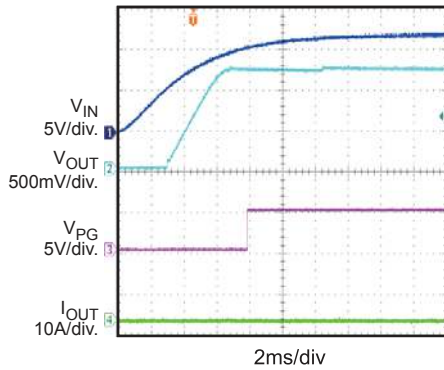
**Power Up Through Input**

6A

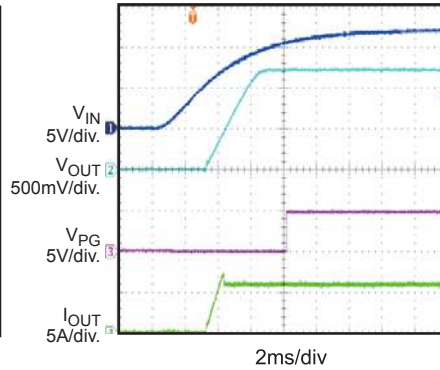
**Output Ripple**

0A

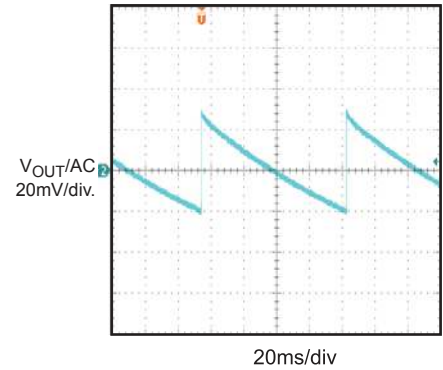
**Output Ripple**

6A

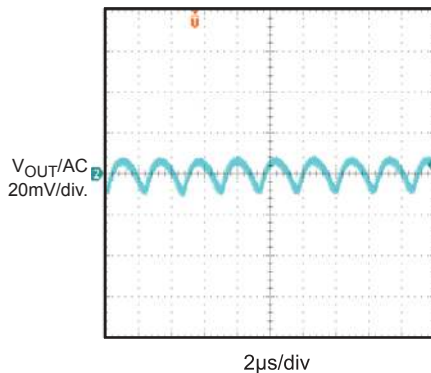
**Over Current Protection**

OCP

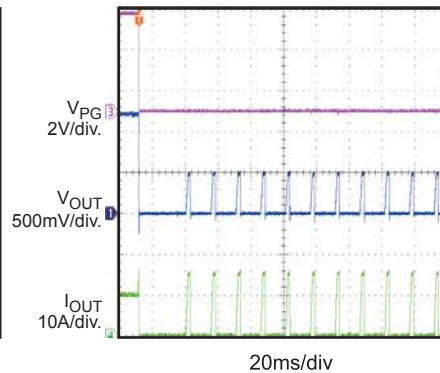
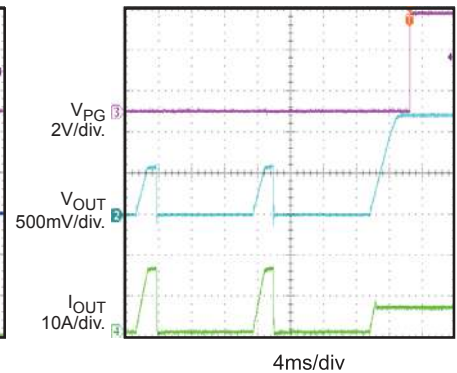
**Over Current Protection Recovery**

PRINTED CIRCUIT BOARD LAYER

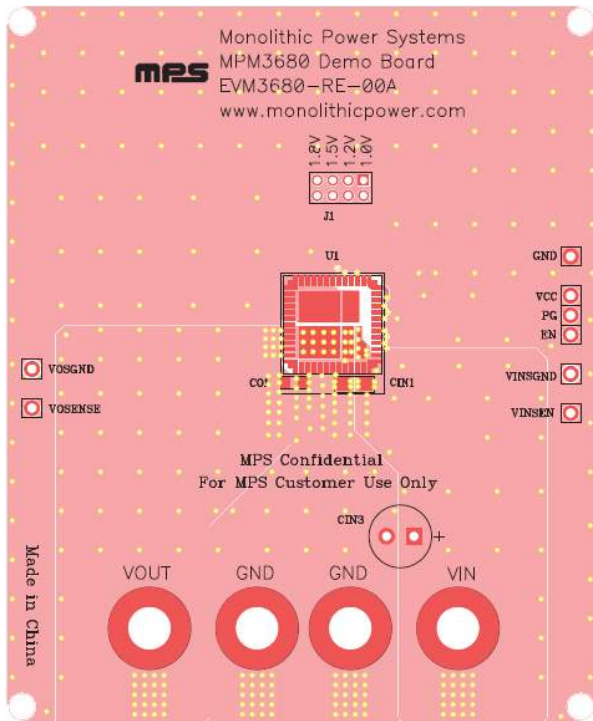

Figure 1: Top Silk Layer

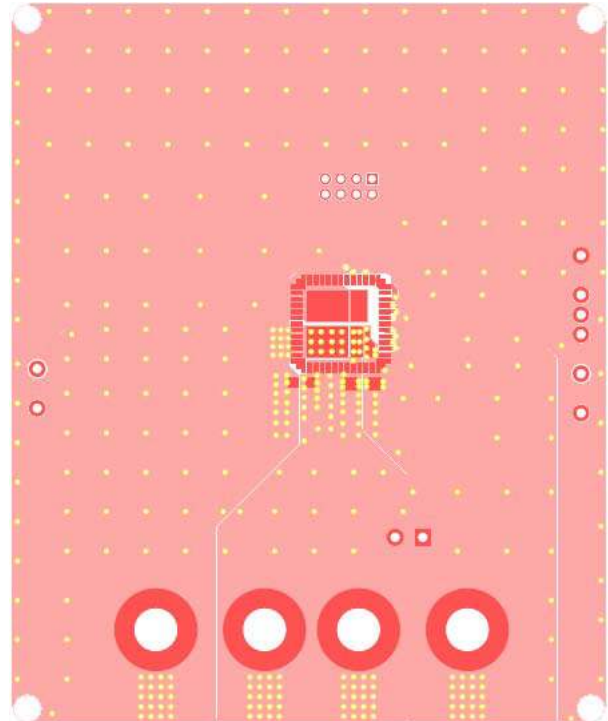

Figure 2: Top Layer



Figure 3: Bottom Silk Layer

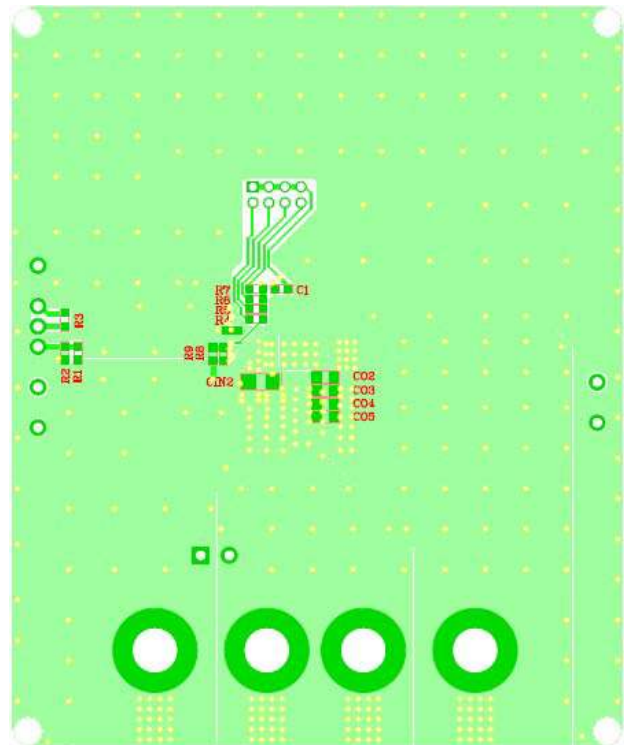

Figure 4: Bottom Layer

## QUICK START GUIDE

The output voltage of this board is set externally which can be regulated as 1V, 1.2V, 1.5V or 1.8V by choosing the jumper position. The input voltage can range from 8V to 18V. The minimum 8V input voltage is limited by the EN signal, which is derived from VIN through a resistor divider. Lower input voltage (as low as 4.5V) can be set by fine tuning the resistor divider values. The following is the procedures to turn on the power module.

1. Put the jumper to the position to the desired output voltage setting.
2. Connect the positive and negative terminals of the load to the VOUT and GND pins, respectively.
3. Preset the power supply output between 8V and 18V, and then turn off the power supply. Make sure the power supply has high enough current limit to supply the current.
4. Connect the positive and negative terminals of the power supply output to the VIN and GND pins, respectively.
5. Turn the power supply on. The power module will automatically start up.

**NOTICE:** The information in this document is subject to change without notice. Please contact MPS for current specifications. Users should warrant and guarantee that third party Intellectual Property rights are not infringed upon when integrating MPS products into any application. MPS will not assume any legal responsibility for any said applications.