



C&K KP Series Piezo Pulse Momentary Pushbutton Switches

Pushbutton
A



Features/Benefits

- Piezo switch element—no mechanical wear
- One piece hermetically sealed construction
- Shock resistant switch, withstands harsh environments
- Available in aluminum and plastic housings
- RoHS compliant models available

Typical Applications

- Industrial controls
- High end instrumentation
- Gas pumps, outdoor environments

Specifications

RATING: 250 mA continuous, 50 V max.
 ELECTRICAL LIFE: 10,000,000 actuations typ.
 CONTACT RESISTANCE: ON: 7.5Ω; OFF: 5 megohms.
 INSULATION RESISTANCE: 10⁹Ω min.
 ACTUATION: 8oz typical up to 3lbs max.
 OPERATING TEMPERATURE: -40°C to 85°C.
 CIRCUIT CLOSURE DURATION: 50 mS min.

Materials

HOUSING: L and S Models: Polyetherimide (UL 94V-0), black, standard; M Models: Aluminum, natural iridite finish.
 WIRE LEADS: 22 AWG with TFE Teflon insulation; Red positive lead, violet negative lead.
 GRAPHIC RETAINING RING: 6/6 nylon (UL 94V-2).
 MOUNTING NUT: L Models: Nylon; M and S Models: Steel, zinc plated.
 LOCKWASHER: M and S Models only: Steel, zinc plated.
 Any models supplied with W4P, W6P or Y4P termination are RoHS compliant and compatible.

NOTE: For the latest information regarding RoHS compliance, please go to: www.ittcannon.com/rohs. Any models supplied with W4P, W6P or Y4P termination are RoHS compliant and compatible.

NOTE: Specifications and materials listed above are for switches with standard options. For information on specific and custom switches, consult Customer Service Center.

Build-A-Switch

To order, simply select desired option from each category and place in the appropriate box. Available options are shown and described on pages A-87 and A-88. For additional options not shown in catalog, consult Customer Service Center.

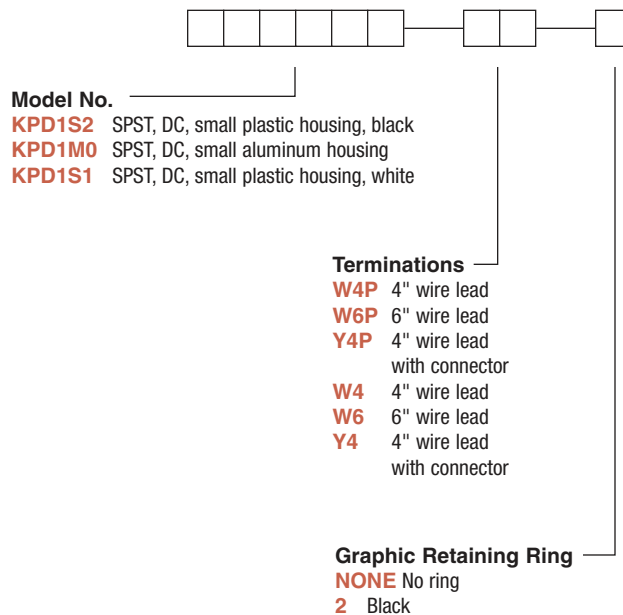

Dimensions are shown: Inches (mm)
 Specifications and dimensions subject to change

C&K KP Series Piezo Pulse Momentary Pushbutton Switches



A

Pushbutton

MODELS

M (Small Aluminum)

MODEL NO.	CIRCUIT TYPE	HOUSING COLOR
KPD1M0	DC	NATURAL
SPST N.O. MOMENTARY (See schematic page A-84.)		

Metal housing of 'M' Small Aluminum Model should be grounded.

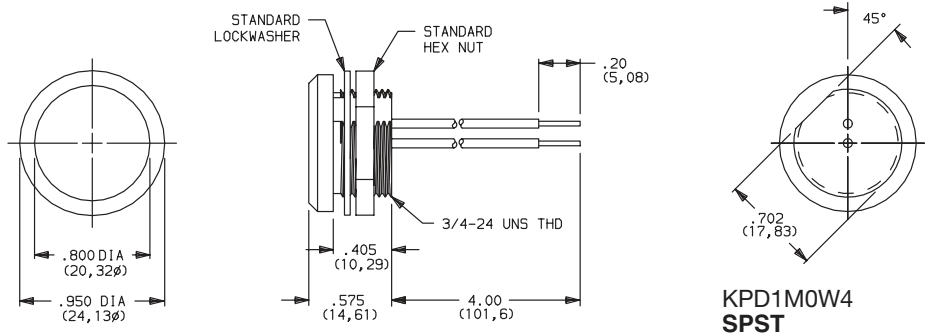

S (Small Plastic)

MODEL NO.	CIRCUIT TYPE	HOUSING COLOR
KPD1S1	DC	WHITE
KPD1S2	DC	BLACK
SPST N.O. MOMENTARY (See schematic page A-84.)		

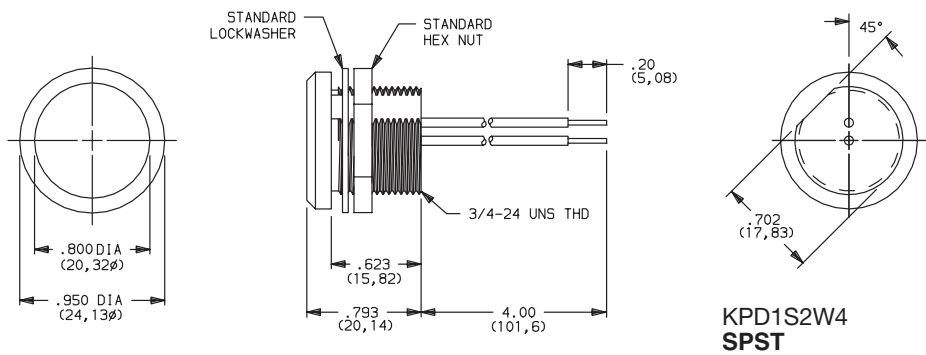

PANEL MOUNTING

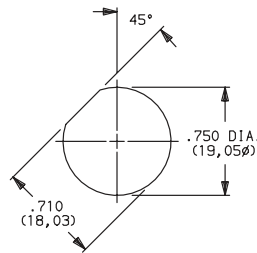

M Models

Panel thickness: .200 (5,80) max.

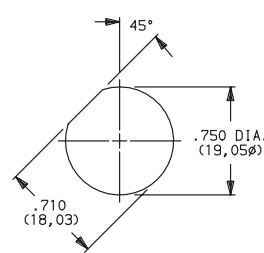

S Models

Panel thickness: .350 (8,89) max.

TERMINATIONS

W4P 4" WIRE LEAD, .20 SKIP
W4 4" WIRE LEAD, .20 STRIP

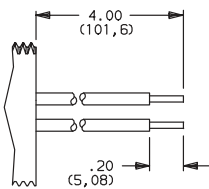

W6P 6" WIRE LEAD, .20 SKIP
W6 6" WIRE LEAD, .20 STRIP

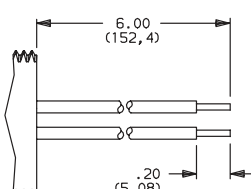

Y4P 4" WIRE LEAD WITH .250" FEMALE INSULATED QUICK CONNECTOR
Y4 4" WIRE LEAD WITH .250" FEMALE INSULATED QUICK CONNECTOR

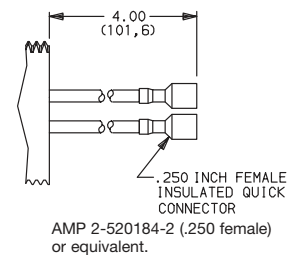

NOTE: Standard wire leads are 22 AWG. Red positive lead, violet negative lead. Other colors, lengths and gauge available, consult Customer Service Center.

W4P, W6P or Y4P options are RoHS compliant and compatible.

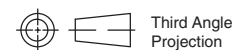

Dimensions are shown: Inches (mm)
Specifications and dimensions subject to change



C&K KP Series Piezo Pulse Momentary Pushbutton Switches

GRAPHIC RETAINING RING

Pushbutton
A

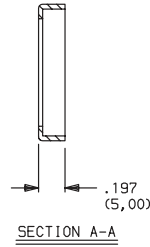
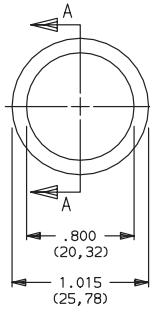

OPTION CODE	RING COLOR
NONE	NO GRAPHIC RING
2	BLACK

Other colors available, consult Customer Service Center.

KPD1S2Y4P2
SPST

RING SIMPLY SNAPS ON—HOLDS GRAPHIC IN POSITION, OR CAN BE USED ALONE AS DECORATIVE TRIM RING.

NOTE: Graphic may be installed by customer or C&K, consult Customer Service Center

SCHEMATICS:

DC- KPD1 MODEL

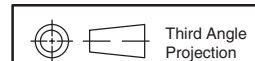
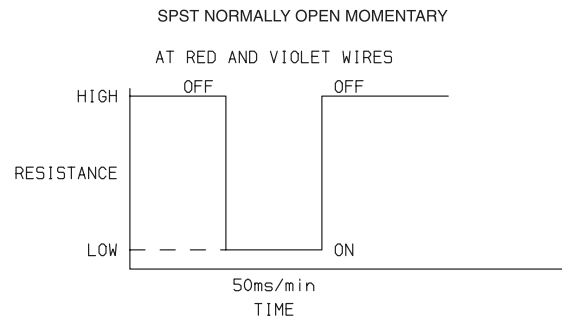
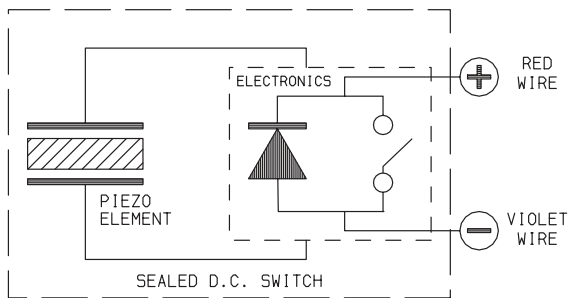

Dimensions are shown: Inches (mm)
Specifications and dimensions subject to change