



Part Number: D3C1415

Electrical Specifications

Frequency Range (GHz):	14.0 – 15.0
Isolation (dB):	23 MIN
Insertion Loss (dB):	0.3 MAX
VSWR:	1.2:1 MIN
Forward Power (W):	10 AVG 50 PK

Mechanical/Environmental Specifications

Connector Type:	SMA
Connector Body:	Passivated stainless steel
Connector Pin:	Gold plated copper
Load Body:	Brass
Magnetic Shunt:	Nickel plated CRS
Operational Temp:	-30°C to +65°C
Weight (oz)	0.9 MAX

D3C1415 Dimensions

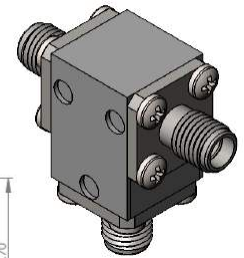
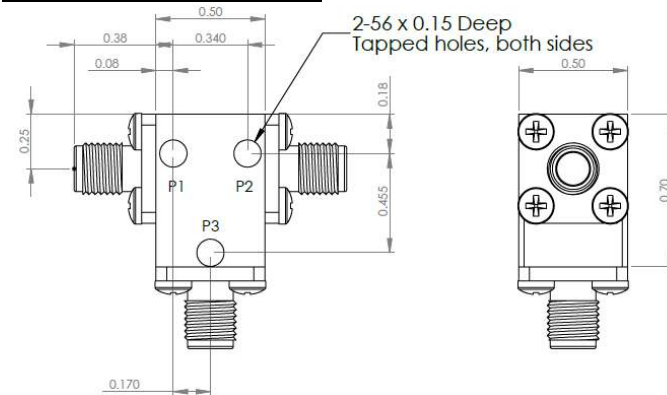

D3C1415-3 Dimensions

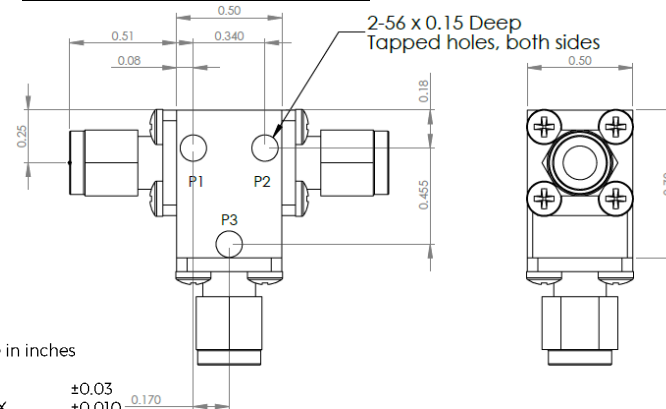

Dimensions are in inches
Tolerance

Type of Device	PN Suffix	Connector Configuration Input / Output	PN Example
Single Junction Circulator 3-Port Device Port 1 / Port 2 / Port 3	No Dash	Female / Female / Female	D3C1415
	-1	Male / Female / Female	D3C1415-1
	-2	Female / Male / Female	D3C1415-2
	-3	Male / Male / Male	D3C1415-3
	-4	Female / Female / Male	D3C1415-4
	-5	Male / Female / Male	D3C1415-5
	-6	Male / Male / Female	D3C1415-6
	-7	Female / Male / Male	D3C1415-7



MEASURED DATA

Part Number: D3C1415, P1→P2, P3 Terminated with 50Ω, +25°C

