



OEG Miniature Relay PCF

TE Internal #: 1888653-5

RJ45 Connectors, RJ45, Multiple Ports, 2 x 1, RJ Type Jacks & Plugs, Standard Connector Contact Density, Jack, Shielded, OEG Miniature Relay PCF

[View on TE.com >](#)

Connectors > Modular Jacks & Plugs > RJ45 Connectors



Modular Jack & Plug Interface Type: **RJ45**

Port Configuration: **Multiple Ports**

Port Matrix Configuration: **2 x 1**

Modular Jacks & Plugs Products: **RJ Type Jacks & Plugs**

Connector Contact Density: **Standard**

**Features**

**Product Type Features**

Connector Product Type	Connector Assembly
Ground Feature Type	Grounding Clips
Modular Jack & Plug Interface Type	RJ45
Modular Jacks & Plugs Products	RJ Type Jacks & Plugs
Modular Connector Style	Jack
Grounding Options	PCB and Panel Ground
Connector & Contact Terminates To	Printed Circuit Board

**Configuration Features**

Status Indicator Type	LED
Panel Ground Location	Sides
Number of PCB Ground Tabs	4
Number of Panel Ground Tabs	12
Multiple Port Configuration	Stacked
Port Configuration	Multiple Ports



Port Matrix Configuration	2 x 1
Connector Contact Density	Standard
Number of Positions	8
Number of Loaded Positions	8
PCB Mount Orientation	Right Angle

### Signal Characteristics

Data Rate	1000 Mb/s
-----------	-----------

### Body Features

LED Color (Top Left)	Green
LED Color (Bottom Left)	None
LED Color (Top Right)	Yellow
Insulator Material	Thermoplastic Polyester
Shield Plating Finish	Tin
LED Color (Bottom Right)	None
Grounding Tab Plating Material	Tin over Copper
Shield Plating Material	Tin over Copper
Shield Material	Copper Alloy
Modular Jack Latch Orientation	Standard - Latch Down
Connector Profile	Offset - Overhangs PCB

### Contact Features

PCB Contact Termination Area Plating Material Finish	Matte
Contact Underplating Material	Nickel
PCB Contact Termination Area Plating Material	Tin
Contact Current Rating (Max)	1.5 A
Contact Mating Area Plating Material	Gold
Contact Base Material	Phosphor Bronze
Contact Mating Area Plating Material Thickness	.38 $\mu$ m[15 $\mu$ in]

### Termination Features

Termination Method to Printed Circuit Board	Through Hole - Press-Fit
Termination Post & Tail Length	4.14 mm[.163 in]

### Mechanical Attachment

Panel Mount Feature	Without
---------------------	---------



PCB Mount Retention Type	SMT Hold Down - Press-Fit
--------------------------	---------------------------

Connector Mounting Type	Board Mount, Panel Mount
-------------------------	--------------------------

### Housing Features

Mating Entry Location	Side
-----------------------	------

Centerline (Pitch)	1.02 mm[.04 in]
--------------------	-----------------

Housing Color	Black
---------------	-------

Housing Material	PBT GF
------------------	--------

### Dimensions

PCB Thickness (Recommended)	1.57 mm[.062 in]
-----------------------------	------------------

Connector Height	3.27 mm[.129 in]
------------------	------------------

### Usage Conditions

Operating Temperature Range	-40 – 85 °C[-40 – 185 °F]
-----------------------------	---------------------------

### Operation/Application

Shielded	Yes
----------	-----

Circuit Application	Signal
---------------------	--------

### Industry Standards

UL Flammability Rating	UL 94V-0
------------------------	----------

Performance Category	Cat 5e
----------------------	--------

### Packaging Features

Packaging Quantity	45
--------------------	----

Packaging Method	Tray
------------------	------

### Product Compliance

For compliance documentation, visit the product page on [TE.com](https://www.te.com)>

EU RoHS Directive 2011/65/EU	Compliant
------------------------------	-----------

EU ELV Directive 2000/53/EC	Compliant
-----------------------------	-----------

China RoHS 2 Directive MIIT Order No 32, 2016	No Restricted Materials Above Threshold
---	---

EU REACH Regulation (EC) No. 1907/2006	Current ECHA Candidate List: JUNE 2023 (235) Candidate List Declared Against: JUL 2021 (219) Does not contain REACH SVHC
--	--

Halogen Content	Not Low Halogen - contains Br or Cl > 900 ppm.
-----------------	--

Solder Process Capability

Not applicable for solder process capability

Product Compliance Disclaimer

This information is provided based on reasonable inquiry of our suppliers and represents our current actual knowledge based on the information they provided. This information is subject to change. The part numbers that TE has identified as EU RoHS compliant have a maximum concentration of 0.1% by weight in homogenous materials for lead, hexavalent chromium, mercury, PBB, PBDE, DBP, BBP, DEHP, DIBP, and 0.01% for cadmium, or qualify for an exemption to these limits as defined in the Annexes of Directive 2011/65/EU (RoHS2). Finished electrical and electronic equipment products will be CE marked as required by Directive 2011/65/EU. Components may not be CE marked. Additionally, the part numbers that TE has identified as EU ELV compliant have a maximum concentration of 0.1% by weight in homogenous materials for lead, hexavalent chromium, and mercury, and 0.01% for cadmium, or qualify for an exemption to these limits as defined in the Annexes of Directive 2000/53/EC (ELV). Regarding the REACH Regulation, the information TE provides on SVHC in articles for this part number is based on the latest European Chemicals Agency (ECHA) 'Guidance on requirements for substances in articles' posted at this URL: <https://echa.europa.eu/guidance-documents/guidance-on-reach>

### Compatible Parts

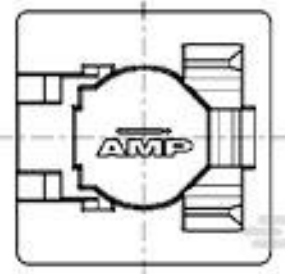

TE Part # 188729-1  
8P.COVER/SOLD.STOP

TE Part # 1521003-2  
CAT 5E CABLE ASSY, 8 POS RJ45

### Also in the Series | OEG Miniature Relay PCF



Coax Connectors(1)



Combo Jacks(1)



IDC D-Sub Connectors(1)



Mini PCI Express & mSATA(1)



RJ14 Connectors(2)



RJ22 Connectors(1)



RJ25 Connectors(8)



RJ45 Connectors(69)



Wire-to-Board Connector Contacts(1)

## Customers Also Bought



TE Part #5787394-7  
68 50SR R/A RCPT ASSY, LD FREE

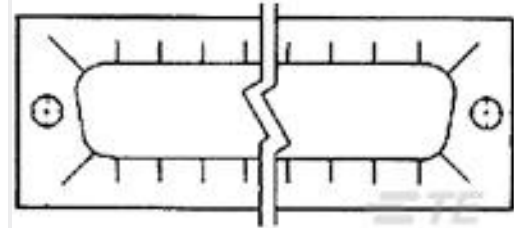

TE Part #5747024-3  
RFI GASKET, SIZE 1, PLATED



TE Part #5555764-1  
MJ,LPF,R/A,8P,SMT,BULK PACK



TE Part #2170703-7  
CAGE ASSEMBLY, QSFP28 1X1,  
SPRING

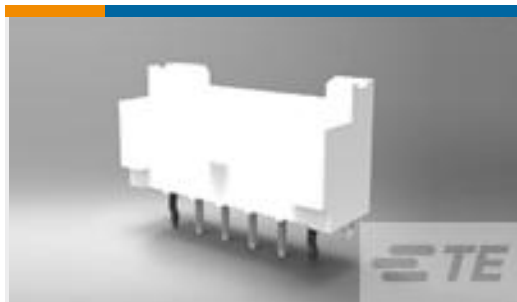

TE Part #2132415-5  
EP2.5 Shrouded HDR ASSY 5P VERT w  
/o boss



TE Part #2169806-1  
IMP,Power,3PR,Vert,Recp,Tin



TE Part #1879216-2  
CPF 0402 51K1 0.1% 25PPM 1K RL

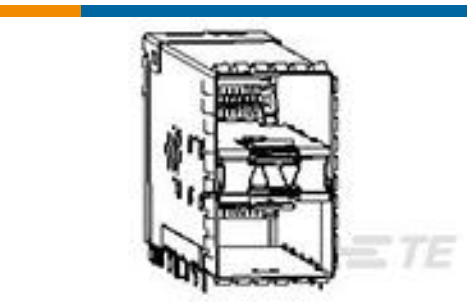

TE Part #2198318-7  
zSFP+ STACKED 2X1 RECEPTACLE  
ASSEMBLY



TE Part #214782-E  
EPSVA KS GDM4 EE 10 3,8 SN \*  
STROMVERSOR

## Documents

### CAD Files

3D PDF

3D

### Customer View Model

[ENG\\_CVM\\_CVM\\_1888653-5\\_C.2d\\_dxf.zip](#)

English

### Customer View Model

[ENG\\_CVM\\_CVM\\_1888653-5\\_C.3d\\_igs.zip](#)



English

### Customer View Model

[ENG\\_CVM\\_CVM\\_1888653-5\\_C.3d\\_stp.zip](#)

English

By downloading the CAD file I accept and agree to the [Terms and Conditions](#) of use.

---

### Product Specifications

#### Product Specification

English

[Offset Stacked Modular Jack with LED\\_s, Category 5](#)

English

---

### Agency Approvals

#### UL Report

English