

MOSFETs Silicon P-Channel MOS (U-MOSVI)

## TJ40S04M3L

### 1. Applications

- Automotive
- Motor Drivers
- DC-DC Converters
- Switching Voltage Regulators

### 2. Features

- (1) AEC-Q101 qualified
- (2) Low drain-source on-resistance:  $R_{DS(ON)} = 7.0 \text{ m}\Omega$  (typ.) ( $V_{GS} = -10 \text{ V}$ )
- (3) Low leakage current:  $I_{DSS} = -10 \text{ }\mu\text{A}$  (max) ( $V_{DS} = -40 \text{ V}$ )
- (4) Enhancement mode:  $V_{th} = -2.0$  to  $-3.0 \text{ V}$  ( $V_{DS} = -10 \text{ V}$ ,  $I_D = -1 \text{ mA}$ )

### 3. Packaging and Internal Circuit

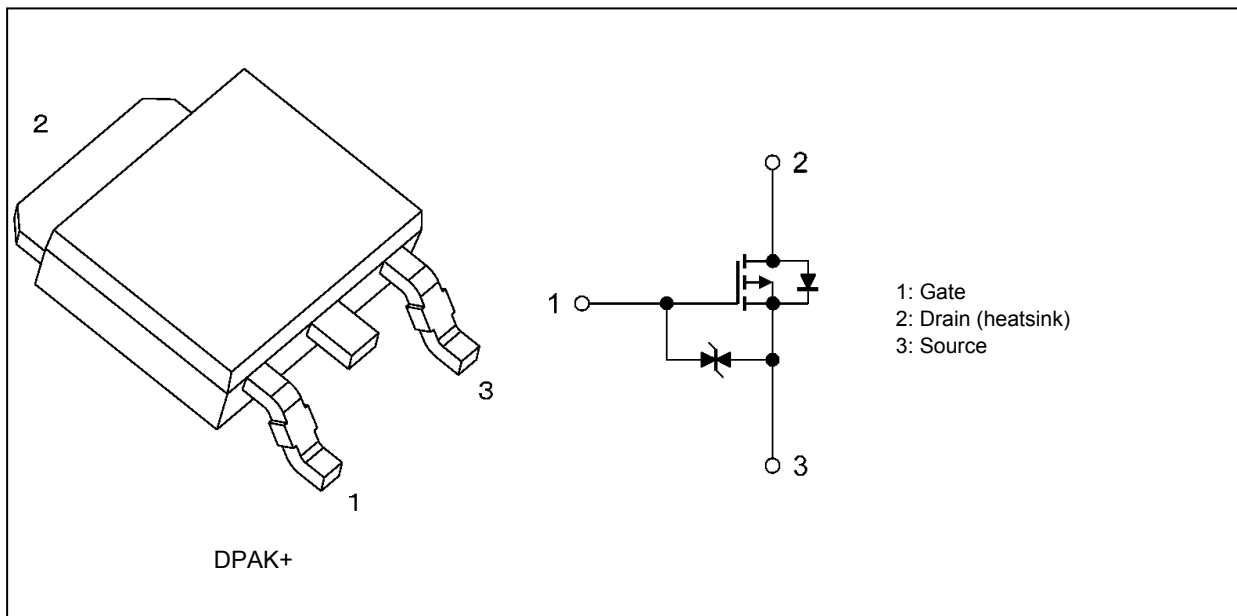

Start of commercial production

2011-03

## 4. Absolute Maximum Ratings (Note) ( $T_a = 25^\circ\text{C}$ unless otherwise specified)

Characteristics	Symbol	Rating	Unit
Drain-source voltage	$V_{DSS}$	-40	V
Gate-source voltage	$V_{GSS}$	-20/+10	
Drain current (DC) (Note 1)	$I_D$	-40	A
Drain current (pulsed) (Note 1)	$I_{DP}$	-80	
Power dissipation ( $T_c = 25^\circ\text{C}$ )	$P_D$	68	W
Single-pulse avalanche energy (Note 2)	$E_{AS}$	72	mJ
Avalanche current	$I_{AR}$	-40	A
Channel temperature (Note 3)	$T_{ch}$	175	$^\circ\text{C}$
Storage temperature (Note 3)	$T_{stg}$	-55 to 175	

Note: Using continuously under heavy loads (e.g. the application of high temperature/current/voltage and the significant change in temperature, etc.) may cause this product to decrease in the reliability significantly even if the operating conditions (i.e. operating temperature/current/voltage, etc.) are within the absolute maximum ratings.

Please design the appropriate reliability upon reviewing the Toshiba Semiconductor Reliability Handbook ("Handling Precautions"/"Derating Concept and Methods") and individual reliability data (i.e. reliability test report and estimated failure rate, etc).

## 5. Thermal Characteristics

Characteristics	Symbol	Max	Unit
Channel-to-case thermal resistance	$R_{th(ch-c)}$	2.2	$^\circ\text{C}/\text{W}$

Note 1: Ensure that the channel temperature does not exceed  $175^\circ\text{C}$ .

Note 2:  $V_{DD} = -25\text{ V}$ ,  $T_{ch} = 25^\circ\text{C}$  (initial),  $L = 47\ \mu\text{H}$ ,  $R_G = 25\ \Omega$ ,  $I_{AR} = -40\text{ A}$

Note 3: The definitions of the absolute maximum channel and storage temperatures are qualified per AEC-Q101.

Note: This transistor is sensitive to electrostatic discharge and should be handled with care.

### 6. Electrical Characteristics

#### 6.1. Static Characteristics ( $T_a = 25^\circ\text{C}$ unless otherwise specified)

Characteristics	Symbol	Test Condition	Min	Typ.	Max	Unit
Gate leakage current	$I_{GSS}$	$V_{GS} = -16/+10\text{ V}, V_{DS} = 0\text{ V}$	—	—	$\pm 10$	$\mu\text{A}$
Drain cut-off current	$I_{DSS}$	$V_{DS} = -40\text{ V}, V_{GS} = 0\text{ V}$	—	—	-10	
Drain-source breakdown voltage	$V_{(BR)DSS}$	$I_D = -10\text{ mA}, V_{GS} = 0\text{ V}$	-40	—	—	V
Drain-source breakdown voltage (Note 4)	$V_{(BR)DSX}$	$I_D = -10\text{ mA}, V_{GS} = 10\text{ V}$	-30	—	—	
Gate threshold voltage	$V_{th}$	$V_{DS} = -10\text{ V}, I_D = -1\text{ mA}$	-2.0	—	-3.0	
Drain-source on-resistance	$R_{DS(ON)}$	$V_{GS} = -6\text{ V}, I_D = -20\text{ A}$	—	8.7	13	$\text{m}\Omega$
		$V_{GS} = -10\text{ V}, I_D = -20\text{ A}$	—	7.0	9.1	

Note 4: If a forward bias is applied between gate and source, this device enters  $V_{(BR)DSX}$  mode. Note that the drain-source breakdown voltage is lowered in this mode.

#### 6.2. Dynamic Characteristics ( $T_a = 25^\circ\text{C}$ unless otherwise specified)

Characteristics	Symbol	Test Condition	Min	Typ.	Max	Unit
Input capacitance	$C_{iss}$	$V_{DS} = -10\text{ V}, V_{GS} = 0\text{ V}, f = 1\text{ MHz}$	—	4140	—	pF
Reverse transfer capacitance	$C_{rss}$		—	410	—	
Output capacitance	$C_{oss}$		—	510	—	
Switching time (rise time)	$t_r$	See Figure 6.2.1.	—	46	—	ns
Switching time (turn-on time)	$t_{on}$		—	63	—	
Switching time (fall time)	$t_f$		—	150	—	
Switching time (turn-off time)	$t_{off}$		—	465	—	

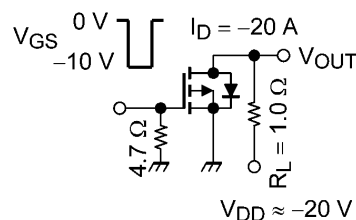

Duty  $\leq 1\%$ ,  $t_w = 10\ \mu\text{s}$   
**Fig. 6.2.1 Switching Time Test Circuit**

#### 6.3. Gate Charge Characteristics ( $T_a = 25^\circ\text{C}$ unless otherwise specified)

Characteristics	Symbol	Test Condition	Min	Typ.	Max	Unit
Total gate charge (gate-source plus gate-drain)	$Q_g$	$V_{DD} \approx -32\text{ V}, V_{GS} = -10\text{ V}, I_D = -40\text{ A}$	—	83	—	nC
Gate-source charge	$Q_{gs}$		—	55	—	
Gate-drain charge	$Q_{gd}$		—	28	—	

#### 6.4. Source-Drain Characteristics ( $T_a = 25^\circ\text{C}$ unless otherwise specified)

Characteristics	Symbol	Test Condition	Min	Typ.	Max	Unit
Reverse drain current (DC) (Note 5)	$I_{DR}$	—	—	—	-40	A
Reverse drain current (pulsed) (Note 5)	$I_{DRP}$	—	—	—	-80	
Diode forward voltage	$V_{DSF}$	$I_{DR} = -40\text{ A}, V_{GS} = 0\text{ V}$	—	—	1.2	V
Reverse recovery time	$t_{rr}$	$I_{DR} = -40\text{ A}, V_{GS} = 0\text{ V}$ $dI_{DR}/dt = 50\text{ A}/\mu\text{s}$	—	39	—	ns
Reverse recovery charge	$Q_{rr}$		—	22	—	nC

Note 5: Ensure that the channel temperature does not exceed  $175^\circ\text{C}$ .

## 7. Marking (Note)

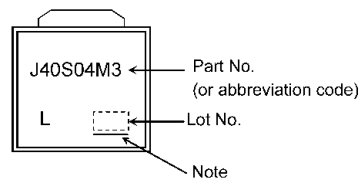

**Fig. 7.1 Marking**

Note: A line under a Lot No. identifies the indication of product Labels.

Not underlined: [[Pb]]/INCLUDES > MCV

Underlined: [[G]]/RoHS COMPATIBLE or [[G]]/RoHS [[Pb]]

Please contact your TOSHIBA sales representative for details as to environmental matters such as the RoHS compatibility of Product.

The RoHS is the Directive 2011/65/EU of the European Parliament and of the Council of 8 June 2011 on the restriction of the use of certain hazardous substances in electrical and electronic equipment.

## 8. Characteristics Curves (Note)

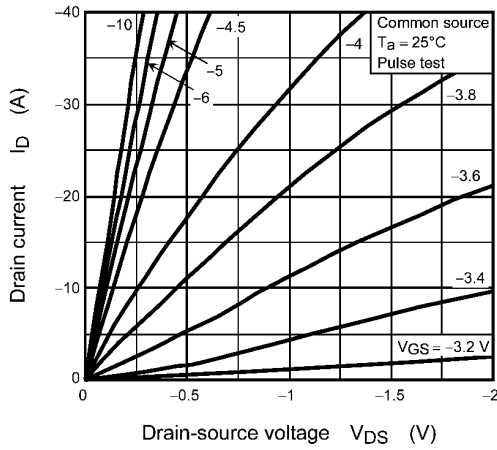

**Fig. 8.1**  $I_D - V_{DS}$

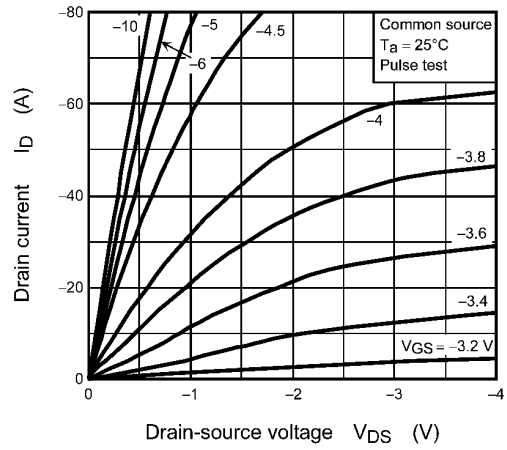

**Fig. 8.2**  $I_D - V_{DS}$

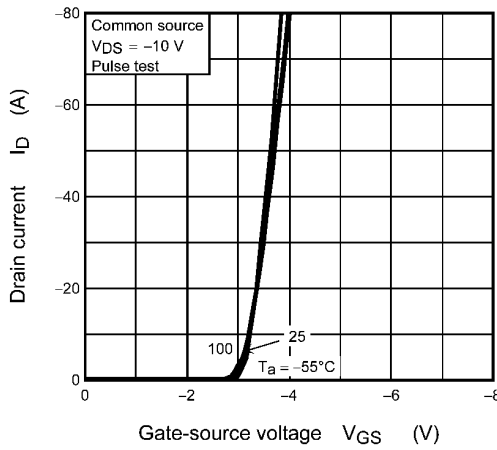

**Fig. 8.3**  $I_D - V_{GS}$

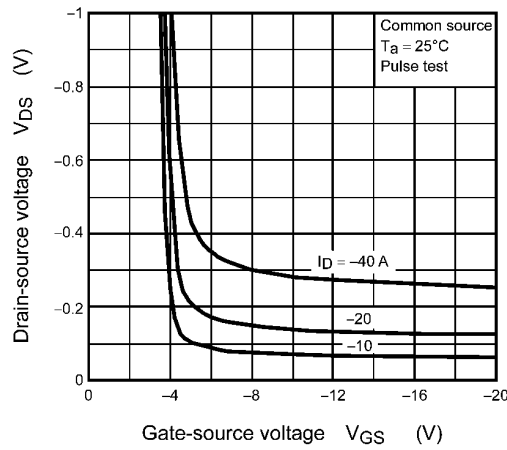

**Fig. 8.4**  $V_{DS} - V_{GS}$

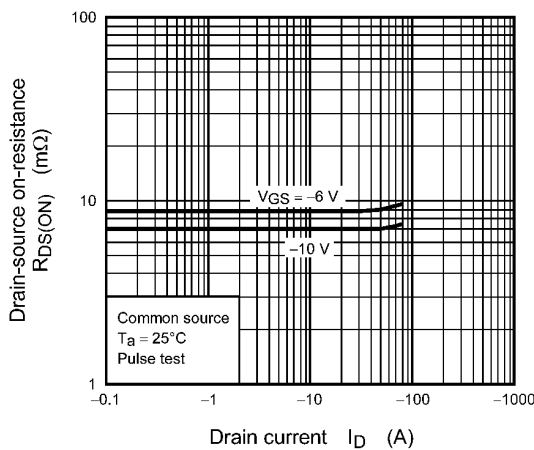

**Fig. 8.5**  $R_{DS(ON)} - I_D$

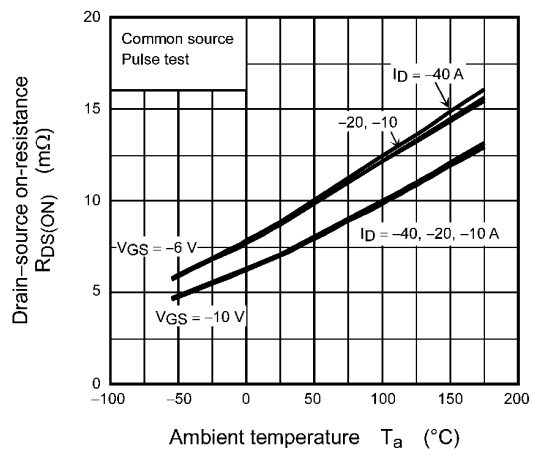

**Fig. 8.6**  $R_{DS(ON)} - T_a$

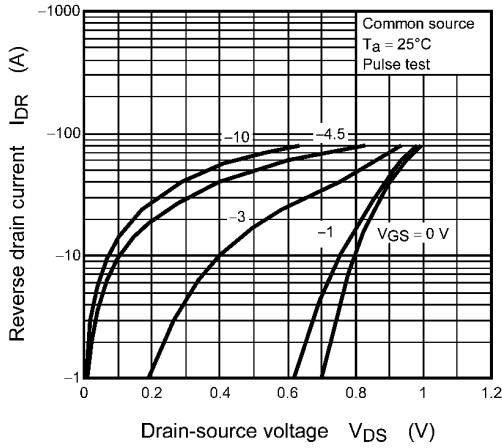

Fig. 8.7  $I_{DR} - V_{DS}$

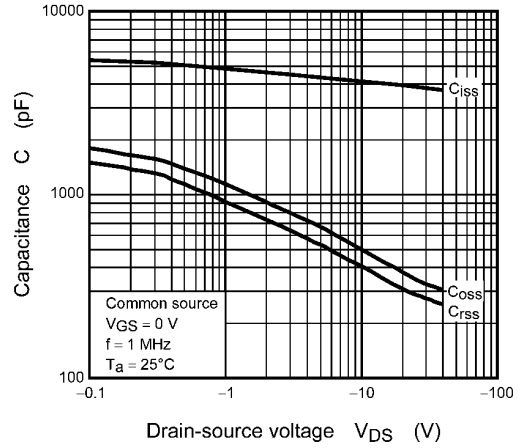

Fig. 8.8 Capacitance -  $V_{DS}$

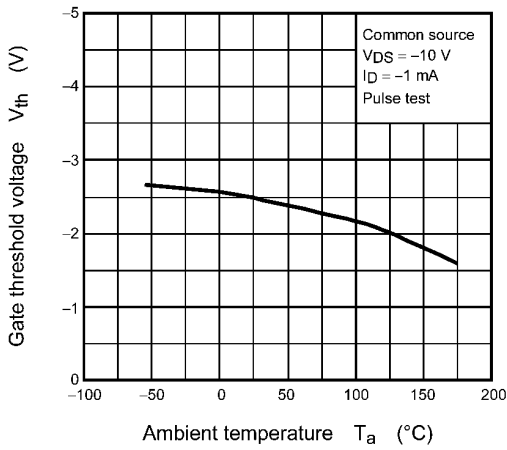

Fig. 8.9  $V_{th} - T_a$

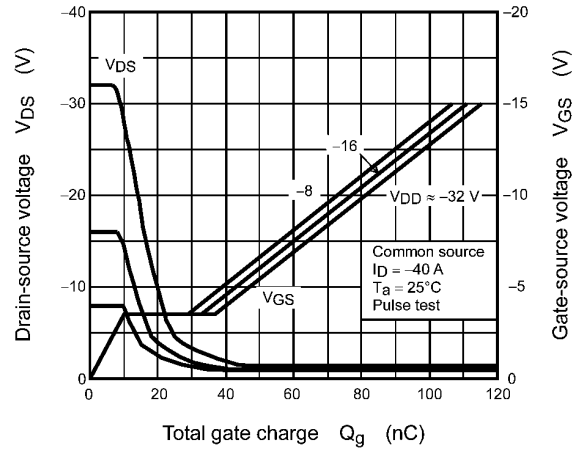

Fig. 8.10 Dynamic Input/Output Characteristics

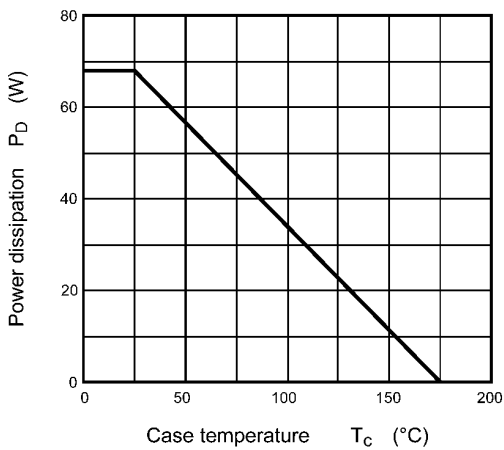
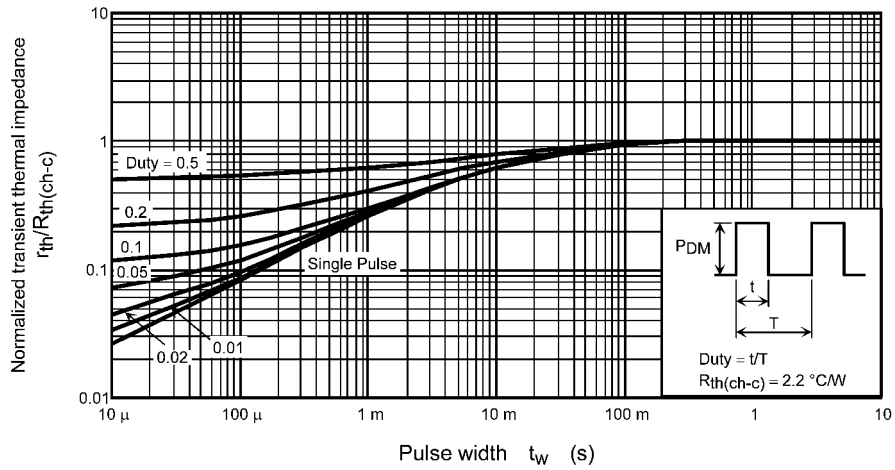
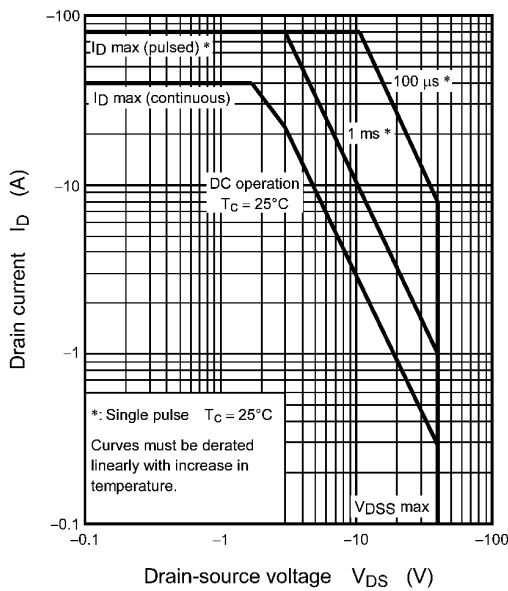

Fig. 8.11  $P_D - T_c$   
 (Guaranteed Maximum)



**Fig. 8.12**  $r_{th}/R_{th(ch-c)} - t_w$   
(Guaranteed Maximum)



**Fig. 8.13** Safe Operating Area  
(Guaranteed Maximum)

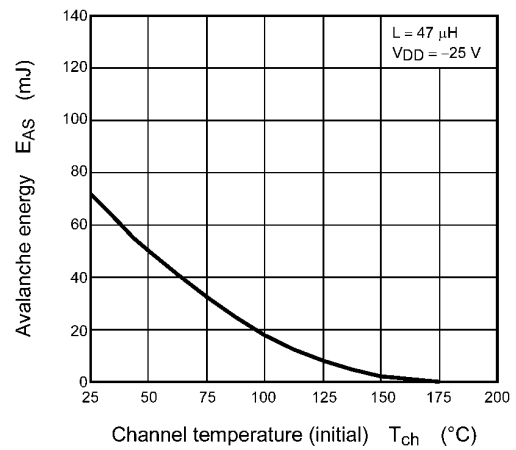

**Fig. 8.14**  $E_{AS} - T_{ch}$   
(Guaranteed Maximum)

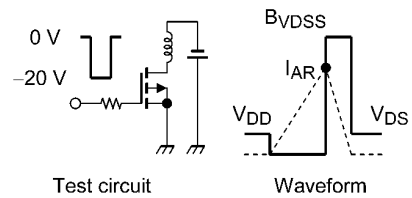

$$R_G = 25 \Omega, V_{DD} = -25 \text{ V}, L = 47 \mu\text{H} \quad E_{AS} = \frac{1}{2} \cdot L \cdot I_{AR}^2 \cdot \left( \frac{B_{VDSS}}{B_{VDSS} - V_{DD}} \right)$$

**Fig. 8.15** Test Circuit/Waveform

Note: The above characteristics curves are presented for reference only and not guaranteed by production test, unless otherwise noted.

## Package Dimensions

Unit: mm



Weight: 0.36 g (typ.)

Package Name(s)
TOSHIBA: 2-7M1A
Nickname: DPAK+



## RESTRICTIONS ON PRODUCT USE

Toshiba Corporation and its subsidiaries and affiliates are collectively referred to as "TOSHIBA".

Hardware, software and systems described in this document are collectively referred to as "Product".

- TOSHIBA reserves the right to make changes to the information in this document and related Product without notice.
- This document and any information herein may not be reproduced without prior written permission from TOSHIBA. Even with TOSHIBA's written permission, reproduction is permissible only if reproduction is without alteration/omission.
- Though TOSHIBA works continually to improve Product's quality and reliability, Product can malfunction or fail. Customers are responsible for complying with safety standards and for providing adequate designs and safeguards for their hardware, software and systems which minimize risk and avoid situations in which a malfunction or failure of Product could cause loss of human life, bodily injury or damage to property, including data loss or corruption. Before customers use the Product, create designs including the Product, or incorporate the Product into their own applications, customers must also refer to and comply with (a) the latest versions of all relevant TOSHIBA information, including without limitation, this document, the specifications, the data sheets and application notes for Product and the precautions and conditions set forth in the "TOSHIBA Semiconductor Reliability Handbook" and (b) the instructions for the application with which the Product will be used with or for. Customers are solely responsible for all aspects of their own product design or applications, including but not limited to (a) determining the appropriateness of the use of this Product in such design or applications; (b) evaluating and determining the applicability of any information contained in this document, or in charts, diagrams, programs, algorithms, sample application circuits, or any other referenced documents; and (c) validating all operating parameters for such designs and applications. **TOSHIBA ASSUMES NO LIABILITY FOR CUSTOMERS' PRODUCT DESIGN OR APPLICATIONS.**
- **PRODUCT IS NEITHER INTENDED NOR WARRANTED FOR USE IN EQUIPMENTS OR SYSTEMS THAT REQUIRE EXTRAORDINARILY HIGH LEVELS OF QUALITY AND/OR RELIABILITY, AND/OR A MALFUNCTION OR FAILURE OF WHICH MAY CAUSE LOSS OF HUMAN LIFE, BODILY INJURY, SERIOUS PROPERTY DAMAGE AND/OR SERIOUS PUBLIC IMPACT ("UNINTENDED USE").** Except for specific applications as expressly stated in this document, Unintended Use includes, without limitation, equipment used in nuclear facilities, equipment used in the aerospace industry, and lifesaving and/or life supporting medical equipment. **IF YOU USE PRODUCT FOR UNINTENDED USE, TOSHIBA ASSUMES NO LIABILITY FOR PRODUCT.** For details, please contact your TOSHIBA sales representative or contact us via our website.
- Do not disassemble, analyze, reverse-engineer, alter, modify, translate or copy Product, whether in whole or in part.
- Product shall not be used for or incorporated into any products or systems whose manufacture, use, or sale is prohibited under any applicable laws or regulations.
- The information contained herein is presented only as guidance for Product use. No responsibility is assumed by TOSHIBA for any infringement of patents or any other intellectual property rights of third parties that may result from the use of Product. No license to any intellectual property right is granted by this document, whether express or implied, by estoppel or otherwise.
- **ABSENT A WRITTEN SIGNED AGREEMENT, EXCEPT AS PROVIDED IN THE RELEVANT TERMS AND CONDITIONS OF SALE FOR PRODUCT, AND TO THE MAXIMUM EXTENT ALLOWABLE BY LAW, TOSHIBA (1) ASSUMES NO LIABILITY WHATSOEVER, INCLUDING WITHOUT LIMITATION, INDIRECT, CONSEQUENTIAL, SPECIAL, OR INCIDENTAL DAMAGES OR LOSS, INCLUDING WITHOUT LIMITATION, LOSS OF PROFITS, LOSS OF OPPORTUNITIES, BUSINESS INTERRUPTION AND LOSS OF DATA, AND (2) DISCLAIMS ANY AND ALL EXPRESS OR IMPLIED WARRANTIES AND CONDITIONS RELATED TO SALE, USE OF PRODUCT, OR INFORMATION, INCLUDING WARRANTIES OR CONDITIONS OF MERCHANTABILITY, FITNESS FOR A PARTICULAR PURPOSE, ACCURACY OF INFORMATION, OR NONINFRINGEMENT.**
- Do not use or otherwise make available Product or related software or technology for any military purposes, including without limitation, for the design, development, use, stockpiling or manufacturing of nuclear, chemical, or biological weapons or missile technology products (mass destruction weapons). Product and related software and technology may be controlled under the applicable export laws and regulations including, without limitation, the Japanese Foreign Exchange and Foreign Trade Law and the U.S. Export Administration Regulations. Export and re-export of Product or related software or technology are strictly prohibited except in compliance with all applicable export laws and regulations.
- Please contact your TOSHIBA sales representative for details as to environmental matters such as the RoHS compatibility of Product. Please use Product in compliance with all applicable laws and regulations that regulate the inclusion or use of controlled substances, including without limitation, the EU RoHS Directive. **TOSHIBA ASSUMES NO LIABILITY FOR DAMAGES OR LOSSES OCCURRING AS A RESULT OF NONCOMPLIANCE WITH APPLICABLE LAWS AND REGULATIONS.**