

# FLIR LEPTON® Engineering Datasheet

## General Description

Lepton® is a complete long-wave infrared (LWIR) camera module designed to interface easily into native mobile-device interfaces and other consumer electronics. It captures infrared radiation input in its nominal response wavelength band (from 8 to 14 microns) and outputs a uniform thermal image with radiometry<sup>1</sup> to provide temperature image with measurements.



## Lepton Features<sup>2</sup>

- Integral shutter configurations
- Configurations with 25°, 50° and 57° HFOV (f/1.1 silicon doublet)
- LWIR sensor, wavelength 8 to 14  $\mu\text{m}$
- Arrays with 80x60 and 160x120 active pixels available
- Thermal sensitivity <50 mK
- Integrated digital thermal image processing functions, including automatic thermal environment compensation, noise filters, non-uniformity correction, and gain control
- Radiometric accuracy<sup>1</sup> (35°C blackbody)
  - High gain:  $\pm 5\text{C}$  @ 25°C
  - Low gain  $\pm 10\text{C}$  @ 25°C
- Radiometric Leptons<sup>1</sup> feature temperature measurement including per pixel and frame radiometric output (TLinear) and Spotmeter
- Export compliant frame rate (< 9 Hz)
- SPI video interface
- Two-wire I2C serial control interface
- Uses standard cell-phone-compatible power supplies: 2.8 V to sensor, 1.2 V to digital core, and flexible IO from 2.8 V to 3.1 V
- Fast time to image (< 1.2 sec)
- Low operating power
  - Nominally 160 mW
  - 800mW typical during shutter event (~1s)
  - Low power mode 5 mW
- RoHS compliant
- 32- pin socket interface to standard Molex or similar side-contact connector

## Applications

- Mobile phones
- Gesture recognition
- Building automation
- Thermal imaging
- Night vision

<sup>1</sup> Radiometric Leptons are 2.5 and 3.5.

<sup>2</sup> All specifications subject to change without notice

The information contained herein does not contain technology as defined by the EAR, 15 CFR 772, is publicly available, and therefore, not subject to EAR. NSR (6/14/2018).

Information on this page is subject to change without notice.

Lepton Engineering Datasheet, Document Number: 500-0659-00-09 Rev: 204



The World's Sixth Sense™

# FLIR LEPTON® Engineering Datasheet

## Contents

<b>1</b>	<b>INTRODUCTION</b>	<b>6</b>
1.1	REVISION HISTORY	6
1.2	CONTACT US	6
1.3	REFERENCES	6
1.4	DEVICE OVERVIEW	8
1.5	KEY SPECIFICATIONS	9
1.6	SYSTEM ARCHITECTURE	11
<b>2</b>	<b>FUNCTIONAL DESCRIPTION</b>	<b>12</b>
2.1	FPA INTERFACE MODULE	12
2.2	SYSTEM CONTROL (SYS CTRL) MODULE	12
2.3	POWER MANAGEMENT MODULE	13
2.4	SOFTWARE-BASED VIDEO PROCESSING (SVP CORE) MODULE	13
2.5	MEMORY SYSTEM (MEMORY SYS) MODULE	13
2.6	GENERAL PURPOSE PROCESSOR (GPP)	13
2.7	VIDEO INTERFACE MODULE (VIDEO IF)	13
2.8	ONE-TIME PROGRAMMABLE MEMORY (OTP)	13
2.9	STATIC RANDOM-ACCESS MEMORY (SRAM)	13
2.10	GPIO INTERFACE MODULE (GPIO IF)	14
2.11	VIDEO PIPELINE	14
2.11.1	<i>NUC</i>	14
2.11.2	<i>Defect Replacement</i>	14
2.11.3	<i>Spatial / Temporal Filtering</i>	14
2.11.4	<i>AGC</i>	15
2.11.5	<i>Colorize</i>	15
2.12	MASTER CLOCK	15
<b>3</b>	<b>OPERATING STATES AND MODES</b>	<b>15</b>
3.1	POWER STATES	15
3.2	FFC STATES	18
3.3	GAIN STATES	22
3.4	TELEMETRY MODES	23
3.5	RADIOMETRY MODES	29

The information contained herein does not contain technology as defined by the EAR, 15 CFR 772, is publicly available, and therefore, not subject to EAR. NSR (6/14/2018).

Information on this page is subject to change without notice.

Lepton Engineering Datasheet, Document Number: 500-0659-00-09 Rev: 204



The World's Sixth Sense™

# FLIR LEPTON® Engineering Datasheet

- 3.5.1 Radiometry Enabled - TLinear ..... 30
- 3.5.2 Radiometry Enabled – Flux linear..... 30
- 3.5.3 Radiometry Disabled ..... 31
- 3.5.4 Radiometric Accuracy – Module..... 32
- 3.5.5 Radiometric Accuracy – System Considerations..... 32
- 3.6 AGC MODES..... 34
- 3.7 VIDEO OUTPUT FORMAT MODES ..... 36
- 3.8 GPIO MODES..... 39
- 4 INTERFACE DESCRIPTIONS ..... 40**
- 4.1 COMMAND AND CONTROL INTERFACE ..... 40
  - 4.1.1 User Defaults Feature..... 42
- 4.2 VoSPI CHANNEL ..... 44
  - 4.2.1 VoSPI Physical Interface ..... 45
  - 4.2.2 VoSPI Protocol – Lepton 1.5, 1.6, 2.0 and 2.5..... 46
  - 4.2.3 VoSPI Protocol – Lepton 3.0 and 3.5 ..... 54
  - 4.2.4 VoSPI Protocol – Lepton 2 vs. Lepton 3 ..... 62
- 5 THERMAL CAMERA BASICS ..... 63**
- 6 MOUNTING SPECIFICATIONS ..... 65**
- 6.1 SOCKET INFORMATION ..... 66
- 6.2 MECHANICAL CONSIDERATIONS ..... 68
- 6.3 THERMAL CONSIDERATIONS..... 69
- 6.4 OPTICAL CONSIDERATIONS ..... 69
- 7 IMAGE CHARACTERISTICS..... 69**
- 8 SPECTRAL RESPONSE ..... 71**
- 9 ELECTRICAL SPECIFICATIONS ..... 73**
- 9.1 LEPTON PIN-OUT ..... 73
- 9.2 DC AND LOGIC LEVEL SPECIFICATIONS ..... 76
- 9.3 AC ELECTRICAL CHARACTERISTICS..... 77
- 9.4 ABSOLUTE MAXIMUM RATINGS ..... 78
- 9.5 ELECTRONIC INTEGRATION CONSIDERATIONS ..... 78
- 10 ENVIRONMENTAL SPECIFICATIONS ..... 79**
- 10.1 COMPLIANCE WITH ENVIRONMENTAL DIRECTIVES..... 80
- 11 ABBREVIATIONS AND ACRONYMS..... 82**

The information contained herein does not contain technology as defined by the EAR, 15 CFR 772, is publicly available, and therefore, not subject to EAR. NSR (6/14/2018).

Information on this page is subject to change without notice.

Lepton Engineering Datasheet, Document Number: 500-0659-00-09 Rev: 204



# FLIR LEPTON® Engineering Datasheet

---

## Table of Figures

Figure 1. Lepton with shutter Camera (with and without socket).....	8
Figure 2 - Lepton Architecture.....	11
Figure 3 - Lepton Detailed Block Diagram.....	12
Figure 4 - Lepton Video Pipeline Block Diagram.....	14
Figure 5 - State Diagram Showing Transitions among the Five Power States.....	16
Figure 6 - Lepton Power Sequencing.....	18
Figure 7 - Examples of Good Uniformity, Graininess, and Blotchiness.....	19
Figure 8 - FFC States.....	21
Figure 9 - Relative Spatial Noise after FFC vs. Number of Integrated Frames ((defaults is 8).....	22
Figure 10 - Hypothetical Illustration of Camera Output in counts vs. Camera Temperature in Radiometry-enabled Mode.....	31
Figure 11 - Hypothetical Illustration of Camera Output vs. Camera Temperature in Radiometry-disabled Mode.....	32
Figure 12 - Illustration of a Histogram for a 3x3 Pixel Area.....	35
Figure 13 - Comparison of Linear AGC and Classic/Lepton Variant of Histogram Equalization.....	36
Figure 14 - Built-in Color Palette.....	38
Figure 15 - Comparison of an Identical Image with Grayscale and a False-color Palette.....	39
Figure 16 - VoSPI Flexible Clock Rate.....	45
Figure 17 - VoSPI I/O.....	45
Figure 18 - SPI Mode 3 (CPOL=1, CPHA=1).....	46
Figure 19 - SPI Bit Order (transmission of 0x8C08).....	46
Figure 20 - Generic VoSPI Packet.....	47
Figure 21 - Video Packet.....	48
Figure 22 - Discard Packet.....	48
Figure 23 - Raw14 Mode: 1 video line per 160-byte payload.....	49
Figure 24 - RGB888 Mode: 1 video line per 240-byte payload.....	49
Figure 25 - Frame Counter for Successive 80x60 Frames.....	51
Figure 26 - Valid Frame Timing (no loss of synchronization).....	52
Figure 27 - Clock Too Slow - Failure to Read an Entire Frame Within the Frame Period.....	53
Figure 28 - Intra-Frame Delay Too Long - Failure to Read Out an Entire Frame Before the Next is Available.....	53

The information contained herein does not contain technology as defined by the EAR, 15 CFR 772, is publicly available, and therefore, not subject to EAR. NSR (6/14/2018).

Information on this page is subject to change without notice.

Lepton Engineering Datasheet, Document Number: 500-0659-00-09 Rev: 204



The World's Sixth Sense™

# FLIR LEPTON® Engineering Datasheet

---

- Figure 29 - Failure to Read Out an Available Frame ..... 53
- Figure 30 - Generic VoSPI Packet..... 55
- Figure 31 - Segment and Packet Relationship to the 160x120 video image..... 55
- Figure 32 - Packet Header Encoding and an Example..... 56
- Figure 33 - Discard Packet..... 57
- Figure 34 - Raw14 Mode: 1 video line per 160-byte payload..... 58
- Figure 35 - RGB888 Mode: 1 video line per 240-byte payload..... 58
- Figure 36 - Location of Telemetry Lines ..... 58
- Figure 37 - Frame Counter for Successive Frames..... 60
- Figure 38 - Valid Frame Timing (no loss of synchronization)..... 61
- Figure 39 - Clock Too Slow - Failure to Read an Entire Frame Within the Frame Period ..... 61
- Figure 40 - Intraframe Delay Too Long - Failure to Read Out an Entire Frame Before the Next is Available..... 62
- Figure 41 - Failure to Read Out an Available Frame ..... 62
- Figure 42 - Illustration of Lepton Detector Time Constant..... 64
- Figure 43 - Lepton with Radiometry Camera Mounting Dimensions..... 65
- Figure 44 - Two Commercially-available Sockets (both from Molex) Compatible with Lepton ..... 66
- Figure 45 - Both Sockets Mounted on a PCB..... 67
- Figure 46 - Recommended Approach to Retaining Lepton in the end Application ..... 68
- Figure 47 - Normalized Response as a Function of Signal Wavelength for Lepton 1.5, 2.0 and 2.5 ..... 71
- Figure 48 - Normalized Response as a Function of Signal Wavelength for Lepton 3.0 and 3.5 ..... 72
- Figure 49 - Pinout Diagram (viewed from bottom of camera module) ..... 73
- Figure 50. Example of Lepton schematic. .... 78

The information contained herein does not contain technology as defined by the EAR, 15 CFR 772, is publicly available, and therefore, not subject to EAR. NSR (6/14/2018).

Information on this page is subject to change without notice.

Lepton Engineering Datasheet, Document Number: 500-0659-00-09 Rev: 204



The World's Sixth Sense™

# FLIR LEPTON® Engineering Datasheet

## 1 Introduction

### 1.1 Revision History

Revision	Date	Description of Change
100	05/03/2016	Lepton with Radiometry release
110	11/12/2016	Updates to include low gain mode feature details
200	03/21/2018	Consolidating all Lepton current configurations into one datasheet. Older document numbers are 500-0771-01-09, 500-0763-01-09, 500-0726-01-09.
201	04/06/2018	Corrected part number for Lepton 1.5. Minor editorial changes. Added document number.
202	07/02/2018	Updated dimensions and weight.
203	08/28/2018	Clarified validity of scene dynamic range. Updated EAR statement. Clarified that THousing in telemetry is only supported for Lepton 2.5 and 3.5.
204	10/08/2019	Updated broken reference.

### 1.2 Contact Us

email: SBA-CORES@FLIR.COM

<http://www.FLIR.com>

### 1.3 References

110-0144-04 Lepton Software Interface Description Document (pdf)

80x60 Lepton VoSPI Developer Guide (pdf)

110-0144-50 Lepton VoSPI Developers Guide (pdf) (For 160x120)

Lepton\_Example\_Schematic\_CAD\_r100.DSN (Cadence-Capture schematic CAD file)

Lepton\_Example\_Schematic\_CAD\_r100.pdf (Cadence-Capture schematic PDF file)

Lepton\_Example\_Schematic\_CAD\_r100.brd (Cadence-Altium PCB layout CAD file)

102-PS245-75 Advanced Radiometry App Note (pdf)

<b>Configuration</b>	<b>Mechanical IDD</b>
----------------------	-----------------------

The information contained herein does not contain technology as defined by the EAR, 15 CFR 772, is publicly available, and therefore, not subject to EAR. NSR (6/14/2018).

Information on this page is subject to change without notice.

Lepton Engineering Datasheet, Document Number: 500-0659-00-09 Rev: 204



The World's Sixth Sense™

# FLIR LEPTON® Engineering Datasheet

---

1.5	500-0643-41.pdf
1.6	500-0690-41.pdf
2.0	500-0659-41.pdf
2.5	500-0763-41.pdf
3.0	500-0726-41.pdf
3.5	500-0771-41.pdf

The information contained herein does not contain technology as defined by the EAR, 15 CFR 772, is publicly available, and therefore, not subject to EAR. NSR (6/14/2018).

Information on this page is subject to change without notice.

Lepton Engineering Datasheet, Document Number: 500-0659-00-09 Rev: 204



The World's Sixth Sense™

# FLIR LEPTON® Engineering Datasheet

---

## 1.4 Device Overview

Lepton is an infrared camera system that integrates a fixed-focus lens assembly, an 80x60 or 160x120 long-wave infrared (LWIR) microbolometer sensor array, and signal-processing electronics. Some configurations are also provided with an integral shutter assembly that is used to automatically optimize image uniformity on a periodic basis. Easy to integrate and operate, Lepton is intended for mobile devices as well as any other application requiring very small footprint, very low power, and instant-on operation. Lepton can be operated in its default mode or configured into other modes through a command and control interface (CCI).

**Figure 1** shows a view of the Lepton with Radiometry camera as standalone and mounted in a socket.

**Figure 1. Lepton with shutter Camera (with and without socket)**

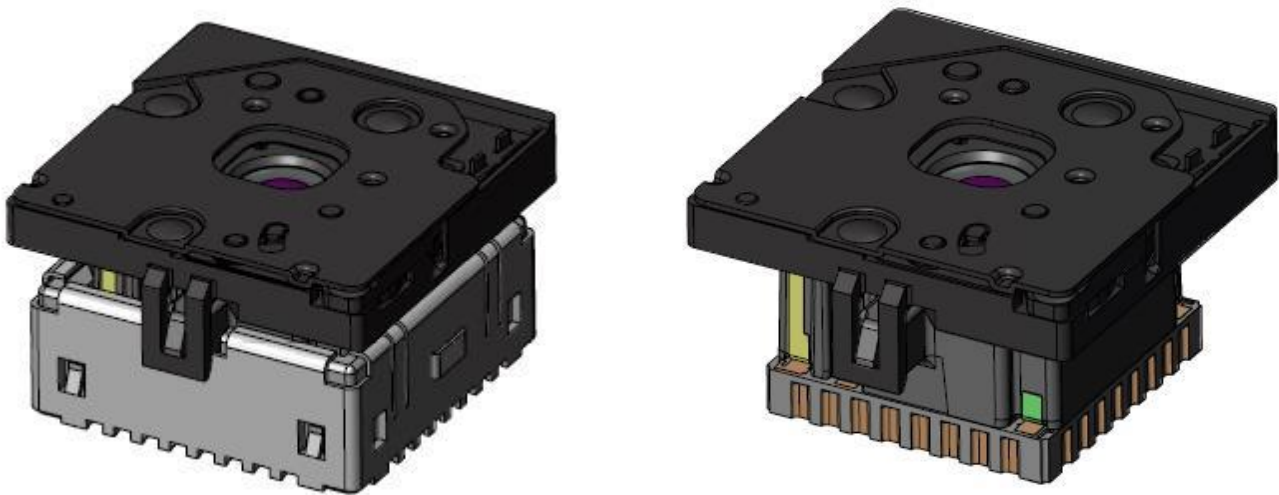

The information contained herein does not contain technology as defined by the EAR, 15 CFR 772, is publicly available, and therefore, not subject to EAR. NSR (6/14/2018).

Information on this page is subject to change without notice.

Lepton Engineering Datasheet, Document Number: 500-0659-00-09 Rev: 204



The World's Sixth Sense™



# FLIR LEPTON® Engineering Datasheet

## 1.5 Key Specifications

**Table 1- Key Specifications**

All numbers are nominal unless tolerances are specified.

Available configurations							
Part number	Array format	Horizontal field of view	Shutter	Thermal radiometry	Distortion (barrel)	Scene Dynamic range <sup>3</sup> - High gain (Low gain)	Pixel pitch
Lepton 1.5: 500-0643-00	80 x 60	50°	No	-	<8%	-10 °C to +140 °C	17 µm
Lepton 1.6: 500-0690-00	80 x 60	25°	No	-	<3%	-10 °C to +140 °C	17 µm
Lepton 2.0: 500-0659-01	80 x 60	50°	Yes	-	<8%	-10 °C to +140 °C	17 µm
Lepton 2.5: 500-0763-01	80 x 60	50°	Yes	Yes	<8%	-10 °C to +140 °C (-10°C to 450°C)	17 µm
Lepton 3.0: 500-0726-01	160 x 120	57°	Yes	-	<13%	-10 °C to +140 °C	12 µm
Lepton 3.5: 500-0771-01	160 x 120	57°	Yes	Yes	<13%	-10 °C to +140 °C (-10°C to 400°C)	12 µm
Overview							
Sensor technology	Uncooled VOx microbolometer						
Spectral range	Longwave infrared, 8 µm to 14 µm						
Video scan	Progressive						
Effective frame rate <sup>4</sup>	8.7 Hz (exportable)						
Thermal sensitivity	<50 mK (0.050°C)						
Temperature compensation	Automatic. Output image independent of camera temperature.						

<sup>3</sup> Scene Dynamic Range is specified at room temperature and may vary over ambient temperature. It is typically somewhat reduced at lower operating temperature.

<sup>4</sup> Lepton 1.5, 1.6, 2.0, 2.5 stream video at 26Hz with every 3 frames repeated (effectively 8.7Hz). Lepton 3.0 and 3.5 stream segments of the images with effectively full frames at 8.7Hz. In this document, when referring to number of frames the frame rate 26Hz is understood.

The information contained herein does not contain technology as defined by the EAR, 15 CFR 772, is publicly available, and therefore, not subject to EAR. NSR (6/14/2018).

Information on this page is subject to change without notice.

Lepton Engineering Datasheet, Document Number: 500-0659-00-09 Rev: 204



The World's Sixth Sense™

# FLIR LEPTON® Engineering Datasheet

Output format	User-selectable 14-bit, 8-bit (AGC applied), or 24-bit RGB (AGC and colorization applied)
Solar protection	Integral
Thermal radiometric accuracy (Lepton 2.5 and 3.5)	<ul style="list-style-type: none"> <li>- High gain mode: Greater of <math>\pm 5</math> °C or 5% (typical)</li> <li>- Low gain mode: Greater of <math>\pm 10</math> °C or 10% (typical)</li> </ul>
<b>Electrical</b>	
Input clock	25-MHz nominal, CMOS IO Voltage Levels in accordance with <b>Electrical Specifications</b> , page 73.
Video data interface	Video over SPI
Control port	CCI (I2C-like), CMOS IO Voltage Levels in accordance with <b>Electrical Specifications</b> , page 73.
Input supply voltage (nominal)	2.8 V, 1.2 V, 2.5 V to 3.1 V IO
Power dissipation	Nominally 150 mW at room temperature (operating), 5 mW (standby). For 2.0, 2.5, 3.0 and 3.5 650mW during shutter event.
<b>Mechanical</b>	
Dimensions [mm] (w × l × h)	Lepton 1.5 (without shutter): 8.47 × 9.67 × 5.62 Lepton 1.6 (without shutter): 8.47 × 9.69 × 8.84 Lepton 2.0 (with shutter): 10.50 × 11.70 × 6.37 Lepton 2.5, 3.0, 3.5 (with shutter): 11.50 × 12.70 × 6.835
Dimensions with socket 105028-101 [mm] (w × l × h)	Lepton 1.5 (without shutter): 10.78 × 10.60 × 5.92 Lepton 1.6 (without shutter): 10.78 × 10.60 × 9.15 Lepton 2.0 (with shutter): 10.78 × 11.70 × 6.68 Lepton 2.5, 3.0, 3.5 (with shutter): 11.50 × 12.70 × 7.14
Weight (typical)	Lepton 1.5, 2.0: 0.68 grams Lepton 2.5: 1.02 grams Lepton 3.0, 3.5: 0.91 grams
<b>Environmental</b>	
Camera operating temperature range	Lepton 1.5, 1.6, 2.0, 2.5, 2.0, 3.5: -10 °C to +80 °C Lepton 2.0, 3.0: Shutter operation limited to -10 °C to +65 °C
Non-operating temperature range	-40 °C to +80 °C
Shock	1500 G @ 0.4 ms

The information contained herein does not contain technology as defined by the EAR, 15 CFR 772, is publicly available, and therefore, not subject to EAR. NSR (6/14/2018).

Information on this page is subject to change without notice.

Lepton Engineering Datasheet, Document Number: 500-0659-00-09 Rev: 204



The World's Sixth Sense™

# FLIR LEPTON® Engineering Datasheet

## 1.6 System Architecture

A simplified architectural diagram of the Lepton camera module is shown in **Figure 2**.

Figure 2 - Lepton Architecture

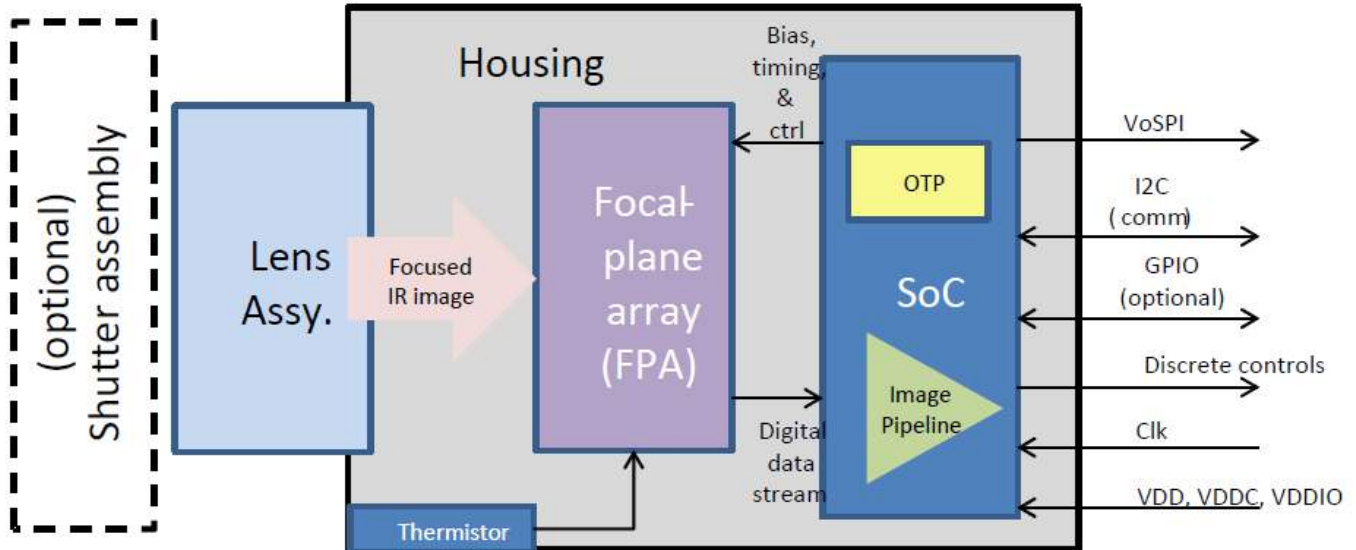

The lens assembly focuses infrared radiation from the scene onto an array of thermal detectors with 17 $\mu\text{m}$  or 12 $\mu\text{m}$  pitch. Each detector element is a vanadium-oxide (VOx) microbolometer whose temperature varies in response to incident flux. The change in temperature causes a proportional change in each microbolometer's resistance. VOx provides a high temperature coefficient of resistance (TCR) and low 1/f noise, resulting in excellent thermal sensitivity and stable uniformity. The microbolometer array is grown monolithically on top of a readout integrated circuit (ROIC) to comprise the complete focal plane array (FPA).

For shuttered configurations, the shutter assembly periodically blocks radiation from the scene and presents a uniform thermal signal to the sensor array, allowing an update to internal correction terms used to improve image quality. For applications in which there is little to no movement of the Lepton camera relative to the scene (for example, fixed-mount security applications), the shutter assembly is recommended. For applications in which there is ample movement (for example, handheld applications), the shutter assembly is less essential although still capable of providing slight improvement to image quality, particularly at start-up and when the ambient temperature varies rapidly. The shutter is also used as a reference for improved radiometric performance.

The information contained herein does not contain technology as defined by the EAR, 15 CFR 772, is publicly available, and therefore, not subject to EAR. NSR (6/14/2018).

Information on this page is subject to change without notice.

Lepton Engineering Datasheet, Document Number: 500-0659-00-09 Rev: 204



The World's Sixth Sense™

# FLIR LEPTON® Engineering Datasheet

The serial stream from the FPA is received by a system on a chip (SoC) device, which provides signal processing and output formatting. This device is more fully defined in [Functional Description](#), page 12.

## 2 Functional Description

A detailed block diagram of the Lepton camera module is shown in [Figure 3](#).

Figure 3 - Lepton Detailed Block Diagram

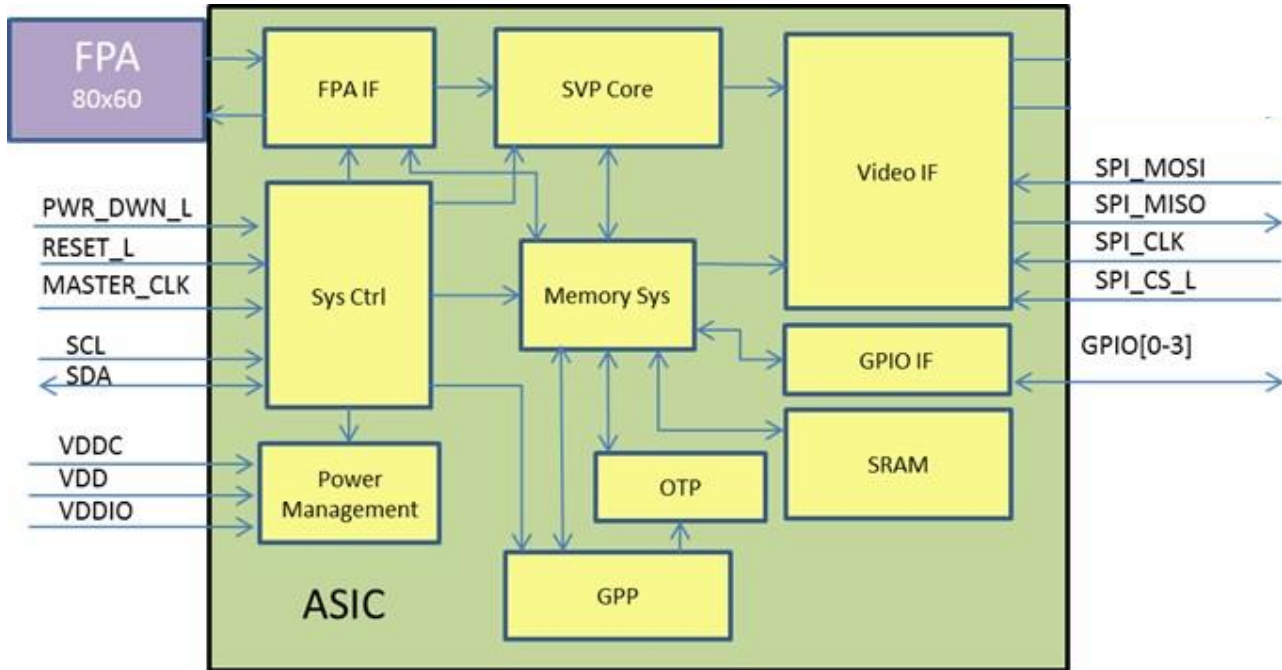

### 2.1 FPA Interface Module

The FPA Interface module generates timing and control signals to the FPA. It also receives and deserializes the digital data stream from the FPA. The output values of on-board temperature sensors are multiplexed into the pixel data stream, and the FPA Interface module strips these out and accumulates them (to improve SNR).

### 2.2 System Control (Sys Ctrl) Module

The System Control module provides the phase-lock-loop (PLL) and generates all clocks and resets required for other modules. It also generates other timing events including syncs and the internal watchdog timer. Additionally, it provides the boot controller, random-number generator, and command and control interface (CCI) decode logic.

The information contained herein does not contain technology as defined by the EAR, 15 CFR 772, is publicly available, and therefore, not subject to EAR. NSR (6/14/2018).

Information on this page is subject to change without notice.

Lepton Engineering Datasheet, Document Number: 500-0659-00-09 Rev: 204



The World's Sixth Sense™

# FLIR LEPTON® Engineering Datasheet

---

## 2.3 Power Management Module

The Power Management module controls the power switches, under direction from the System Control Module.

## 2.4 Software-based Video Processing (SVP Core) Module

The SVP Core module is an asymmetric multi-core digital signal processor (DSP) engine that provides the full video pipeline, further described in [Video Pipeline](#), page 14.

## 2.5 Memory System (Memory Sys) Module

The Memory System module provides the memory interface to all the other modules that require access to SRAM and/or OTP.

## 2.6 General Purpose Processor (GPP)

The GPP is a central processing unit (CPU) that provides the following functionality:

- Servicing of CCI commands
- Initialization and configuration of the video pipeline
- Power management
- Other housekeeping functions

## 2.7 Video Interface Module (Video IF)

The Video Interface module receives video data and formats it for VoSPI protocol (see documents in [References](#), page 6).

## 2.8 One-Time Programmable Memory (OTP)

The OTP memory contains all the non-volatile data for the camera, including the software programs for the SVP Core and GPP as well as calibration data and camera-unique data (such as serial number). There are no provisions for directly writing to OTP memory outside of the Lepton factory, except the User Default values as described below.

An optional User Default feature is available on some Lepton versions to configure the desired defaults (e.g. FFC mode, radiometry configuration, etc.), and write these defaults once by the user to OTP. This feature removes the needs for an initialization sequence at start-up to configure the desired run-time settings. See [User Defaults Feature](#), page 42.

## 2.9 Static Random-Access Memory (SRAM)

SRAM is the primary volatile memory utilized by all other modules.

The information contained herein does not contain technology as defined by the EAR, 15 CFR 772, is publicly available, and therefore, not subject to EAR. NSR (6/14/2018).

Information on this page is subject to change without notice.

Lepton Engineering Datasheet, Document Number: 500-0659-00-09 Rev: 204



The World's Sixth Sense™

# FLIR LEPTON® Engineering Datasheet

## 2.10 GPIO Interface Module (GPIO IF)

The General-Purpose Input / Output (GPIO) Interface module implements the GPIO pins, which can be runtime configured (see [GPIO Modes](#), page 39).

## 2.11 Video Pipeline

A block diagram of the video pipeline is shown in [Figure 4](#).

Figure 4 - Lepton Video Pipeline Block Diagram

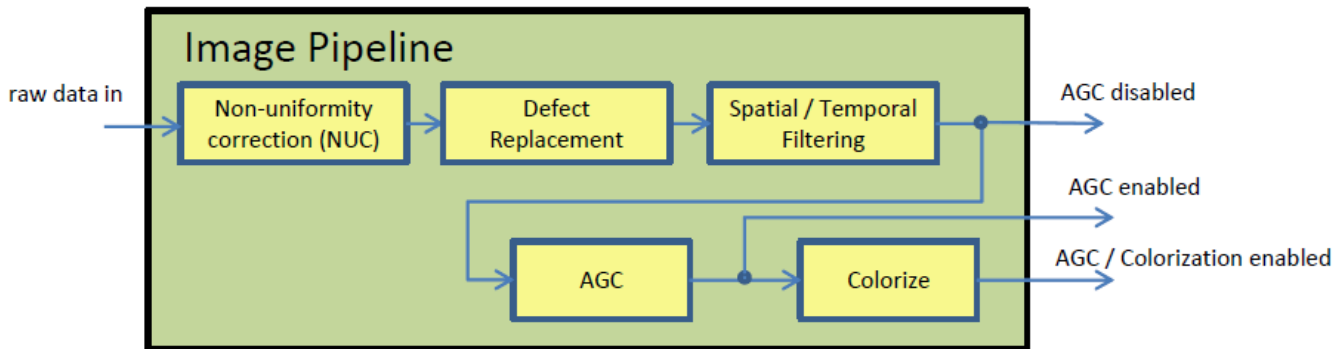

The video pipeline includes non-uniformity correction (NUC), defect replacement, spatial and temporal filtering, automatic gain correction (AGC), and colorization.

### 2.11.1 NUC

The non-uniformity correction (NUC) block applies correction terms to ensure that the camera produces a uniform output for each pixel when imaging a uniform thermal scene. Factory-calibrated terms are applied to compensate for temperature effects, pixel response variations, and lens-illumination roll-off. To compensate for temporal drift, the NUC block also applies an offset term that can be periodically updated at runtime via a process called flat-field correction (FFC). The FFC process is further described in [FFC States](#), page 18.

### 2.11.2 Defect Replacement

The defect-replacement block substitutes for any pixels identified as defective during factory calibration or during runtime. The replacement algorithm assesses the values of neighboring pixels and calculates an optimum replacement value.

### 2.11.3 Spatial / Temporal Filtering

The image pipeline includes several sophisticated image filters designed to enhance signal-to-noise ratio (SNR) by eliminating temporal noise and residual non-uniformity. The filtering suite includes a scene-based non-uniformity

The information contained herein does not contain technology as defined by the EAR, 15 CFR 772, is publicly available, and therefore, not subject to EAR. NSR (6/14/2018).

Information on this page is subject to change without notice.

Lepton Engineering Datasheet, Document Number: 500-0659-00-09 Rev: 204



The World's Sixth Sense™

# FLIR LEPTON® Engineering Datasheet

---

correction (SBNUC) algorithm which relies on motion within the scene to isolate fixed pattern noise (FPN) from image content.

## 2.11.4 AGC

The AGC algorithm for converting the full-resolution (14-bit) thermal image into a contrast-enhanced image suitable for display is a histogram-based non-linear mapping function. [AGC Modes](#), page 34.

## 2.11.5 Colorize

The colorize block takes the contrast-enhanced thermal image as input and generates a 24-bit RGB color output. See [Video Output Format Modes](#), page 36.

## 2.12 Master Clock

In Lepton the master clock (MASTER\_CLOCK) frequency is 25 MHz.

## 3 Operating States and Modes

Lepton provides several operating states and modes, more completely defined in the sections that follow:

- [Power States](#), page 15
- [FFC States](#), page 18
- [Gain States](#) page 22
- [Telemetry Modes](#), page 23
- [Radiometry Modes](#), page 29
- [AGC Modes](#), page 34
- [Video Output Format Modes](#), page 36
- [GPIO Modes](#), page 39

### 3.1 Power States

Lepton currently provides five power states. As depicted in the state diagram shown in [Figure 5](#), most of the transitions among the power states are the result of explicit action from the host. The automatic transition to and from the over-temperature (Overtemp) state is an exception.

The information contained herein does not contain technology as defined by the EAR, 15 CFR 772, is publicly available, and therefore, not subject to EAR. NSR (6/14/2018).

Information on this page is subject to change without notice.

Lepton Engineering Datasheet, Document Number: 500-0659-00-09 Rev: 204



The World's Sixth Sense™

# FLIR LEPTON® Engineering Datasheet

Figure 5 - State Diagram Showing Transitions among the Five Power States

Note: Transition to "off" from every other state occurs by removing VDD, VDDC, and VDDIO. For simplicity, these transitions are not shown below

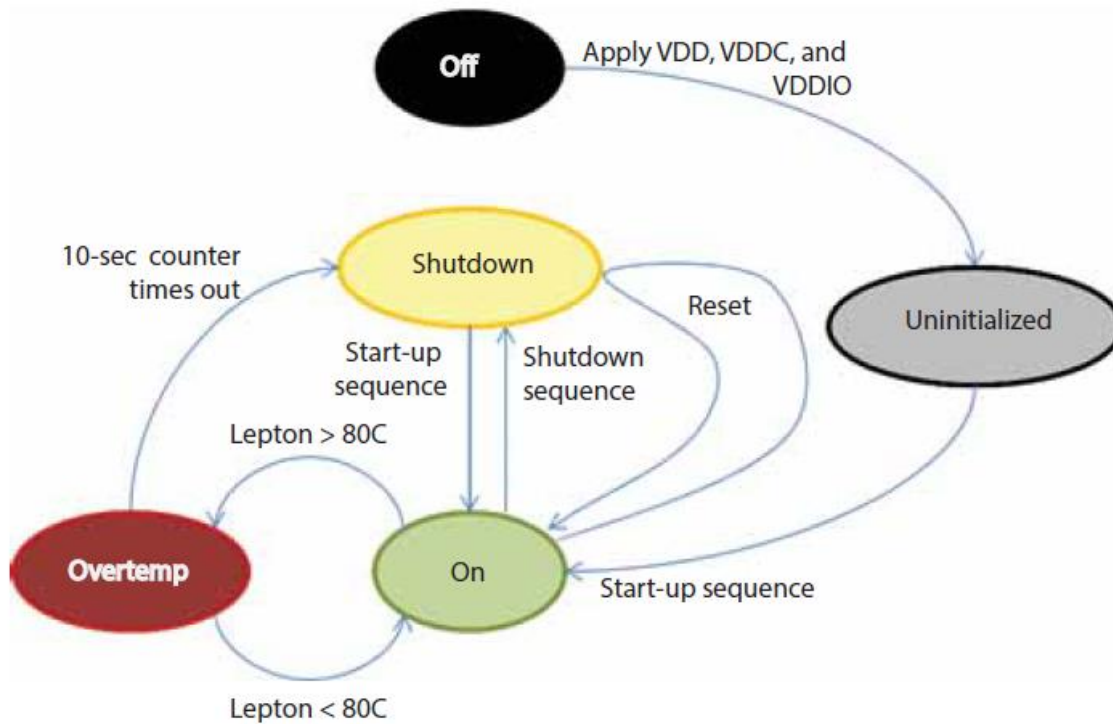

The power states are listed here:

- **Off**: When no voltage is applied, Lepton is in the off state. In the off state, no camera functions are available.
- **Uninitialized**: In the uninitialized state, all voltage forms are applied, but Lepton has not yet been booted and is in an indeterminate state. It is not recommended to leave Lepton in this state as power is not optimized; it should instead be booted to the on-state (and then transitioned back to Shutdown if imaging is not required).
- **On**: In the on state, all functions and interfaces are fully available.

The information contained herein does not contain technology as defined by the EAR, 15 CFR 772, is publicly available, and therefore, not subject to EAR. NSR (6/14/2018).

Information on this page is subject to change without notice.

Lepton Engineering Datasheet, Document Number: 500-0659-00-09 Rev: 204



The World's Sixth Sense™



## FLIR LEPTON® Engineering Datasheet

---

- **Shutdown:** In the shutdown state, all voltage forms are applied, but power consumption is approximately 5 mW. In the shutdown state, no functions are available, but it is possible to transition to the on state via the start-up sequence defined in [Figure 6](#). The shutdown sequence shown in [Figure 6](#) is the recommended transition back to the shutdown state. It is also possible to transition between shutdown and on states via software commands, as further defined in the software IDD.
- **Overtemp:** The Overtemp state is automatically entered when the Lepton senses that its temperature has exceeded approximately 80 °C. Upon entering the Overtemp state, Lepton enables a “shutdown imminent” status bit in the telemetry line and starts a 10-second counter. If the temperature of the Lepton falls below 80 °C before the counter times out, the “shutdown imminent” bit is cleared and the system transitions back to the on state. If the counter does time out, Lepton automatically transitions to the standby state.

Power sequencing is as shown in [Figure 6](#).

The information contained herein does not contain technology as defined by the EAR, 15 CFR 772, is publicly available, and therefore, not subject to EAR. NSR (6/14/2018).

Information on this page is subject to change without notice.

Lepton Engineering Datasheet, Document Number: 500-0659-00-09 Rev: 204



The World's Sixth Sense™

Figure 6 - Lepton Power Sequencing

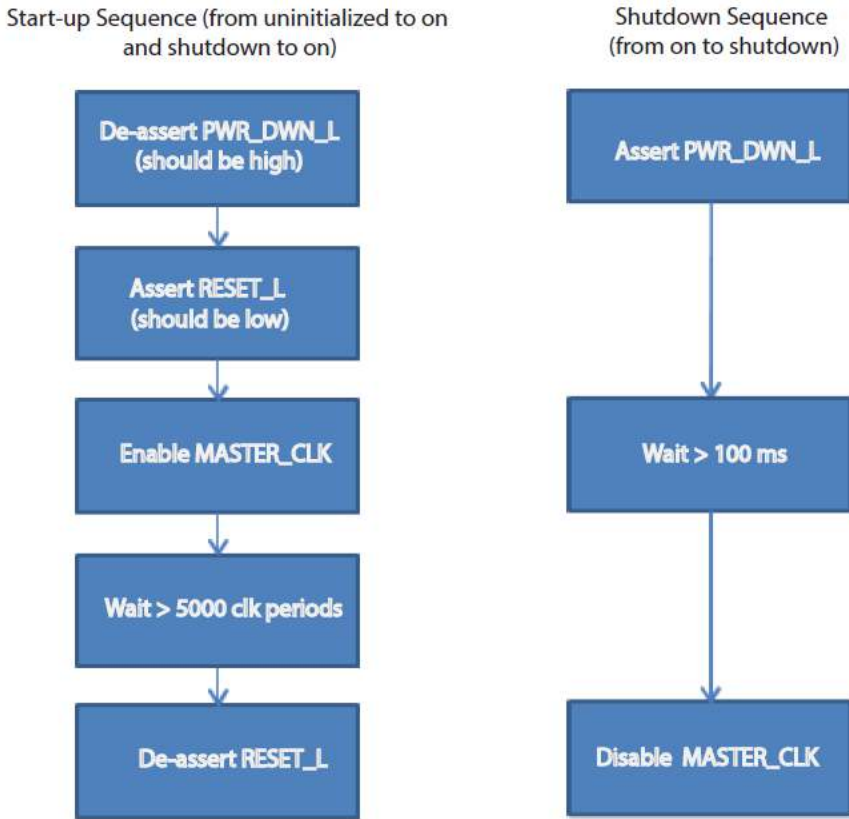

### 3.2 FFC States

Lepton is factory calibrated to produce an output image that is highly uniform, such as shown in [Figure 7 \(a\)](#), when viewing a uniform-temperature scene. However, drift effects over long periods of time degrade uniformity, resulting in imagery which appears grainier [Figure 7 \(b\)](#) and/or blotchy [Figure 7 \(c\)](#). Columns and other pixel combinations may drift as a group. These drift effects may occur even while the camera is powered off. Operation over a wide temperature range (for example, powering on at -10 °C and heating to 65 °C without performing and FFC) will also have a detrimental effect on image quality and radiometric accuracy.

For scenarios in which there is ample scene movement, such as most handheld applications, Lepton is capable of automatically compensating for drift effects using an internal algorithm called scene-based non-uniformity correction (scene-based NUC or SBNUC). However, for use cases in which the scene is essentially stationary, such

The information contained herein does not contain technology as defined by the EAR, 15 CFR 772, is publicly available, and therefore, not subject to EAR. NSR (6/14/2018).

Information on this page is subject to change without notice.

Lepton Engineering Datasheet, Document Number: 500-0659-00-09 Rev: 204



The World's Sixth Sense™

# FLIR LEPTON® Engineering Datasheet

as fixed-mount applications, scene-based NUC is less effective. In stationary applications and those which need highest quality or quickly available video, it is recommended to periodically perform a flat-field correction (FFC). FFC is a process whereby the NUC terms applied by the camera's signal processing engine are automatically recalibrated to produce the most optimal image quality. The sensor is briefly exposed to a uniform thermal scene, and the camera updates the NUC terms to ensure uniform output. The entire FFC process takes less than a second.

**Figure 7 - Examples of Good Uniformity, Graininess, and Blotchiness**

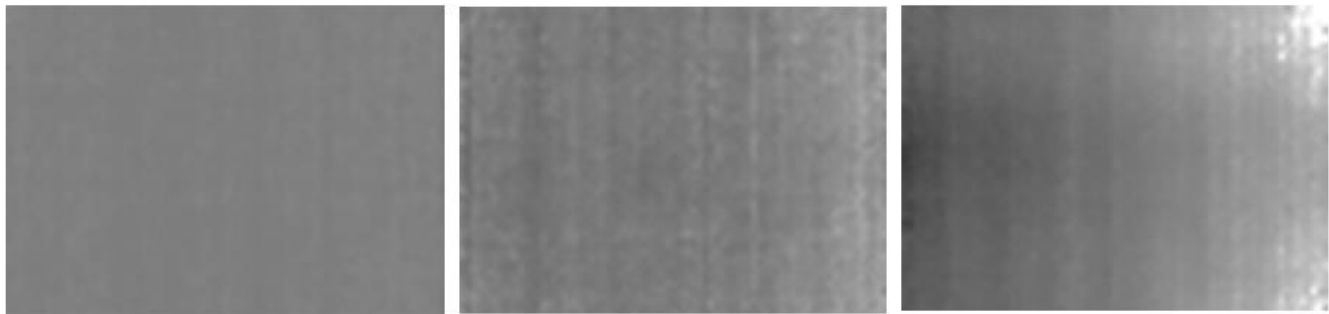

(a) Highly uniform image

(b) Grainy image  
(high-spatial frequency noise)

(c) Blotchy image  
(low-spatial frequency noise)

Lepton provides three different FFC modes:

- External (default for shutter-less configurations)
- Manual
- Automatic (default for configurations with shutter)

In external FFC mode, FFC is only executed upon command, and it should only be commanded when the camera is imaging an external uniform source of a known temperature. To ensure radiometric accuracy in this mode, the user must explicitly update the radiometry shutter mode to "User" and input the temperature of the scene during FFC via the CCI. If in imaging mode only and temperature measurement is not required (radiometry disabled), any uniform source such as a uniform wall will suffice.

Manual FFC mode is also executed only upon command, except that when FFC is commanded, Lepton closes its integral shutter throughout the process. Note that it is not necessary to ensure a uniform external scene of a known temperature before commanding FFC in manual FFC mode because the shutter serves as the uniform source and includes a temperature sensor with automatic input for radiometric measurements.

The information contained herein does not contain technology as defined by the EAR, 15 CFR 772, is publicly available, and therefore, not subject to EAR. NSR (6/14/2018).

Information on this page is subject to change without notice.

Lepton Engineering Datasheet, Document Number: 500-0659-00-09 Rev: 204



The World's Sixth Sense™

# FLIR LEPTON® Engineering Datasheet

---

In automatic FFC, the Lepton camera will automatically perform FFC under the following conditions:

- At start-up
- After a specified period of time (default of 3 minutes) has elapsed since the last FFC
- If the camera temperature has changed by more than a specified value (default of 1.5 Celsius degrees) since the last FFC

The time trigger and the temperature-change trigger described above are both adjustable parameters via the CCI; however, the default values are recommended under most operating conditions. Decreasing the temperature or time interval to FFC more often will provide better radiometric accuracy, but the tradeoff is decrease in useful camera output and radiometry readings due to the increased occurrence of FFC.

The current FFC state is provided through the telemetry line. There are four FFC states, enumerated below and illustrated in [Figure 8](#):

1. **FFC not commanded (default):** In this state, Lepton applies by default a set of factory-generated FFC terms. In automatic FFC mode, this state is generally not seen because Lepton performs automatic FFC at start-up.
2. **FFC imminent:** The camera only enters this state when it is operating in automatic FFC mode. The camera enters “FFC imminent” state at a specified number of frames (default of 52 frames at 26Hz, or approximately 2 seconds) prior to initiating an automatic FFC. The intent of this status is to warn the host that an FFC is about to occur.
3. **FFC in progress:** Lepton enters this state when FFC is commanded from the CCI or when automatic FFC is initiated. The default FFC duration is nominally 23 frames at 26Hz, in which case the camera integrates 8 frames of output as the basis for the correction (the additional frames are overhead). It is possible to configure the FFC to integrate fewer or more frames (from 1 to 128 in powers of 2). Utilizing fewer frames obviously decreases the FFC period (with diminishing returns due to overhead) whereas utilizing more frames provides greater reduction of spatial noise (also with diminishing returns due to 1/f noise). [Figure 9](#) quantifies the benefit. Radiometry readings are invalid during this state.
4. **FFC complete:** Lepton automatically enters this state whenever a commanded or automatic FFC is completed.

Lepton also provides an “FFC desired” flag in the telemetry line. The “FFC desired” flag is asserted under the same conditions that cause automatic FFC when in automatic FFC mode. That is, the “FFC desired” flag is asserted at start-up, when a specified period (default = 3 minutes) has elapsed since the last FFC, or when the sensor temperature has changed by a specified value (default = 1.5 Celsius degrees) since the last FFC. In automatic mode, the camera immediately enters “FFC imminent” state when “FFC desired” is true. In manual FFC mode and

The information contained herein does not contain technology as defined by the EAR, 15 CFR 772, is publicly available, and therefore, not subject to EAR. NSR (6/14/2018).

Information on this page is subject to change without notice.

Lepton Engineering Datasheet, Document Number: 500-0659-00-09 Rev: 204



The World's Sixth Sense™

# FLIR LEPTON® Engineering Datasheet

external FFC mode, the “FFC desired” flag is intended to indicate to the host to command an FFC at the next possible opportunity.

Lepton automatically prohibits the shutter from operating when it detects the temperature to be outside the range -10°C to +80°C<sup>5</sup>. For example, if the camera is operating at a temperature of -15°C, no automatic FFC will be performed, and the camera will ignore any commanded FFC if the FFC mode is “automatic” or “manual.” Normal operation of the shutter will automatically resume when the temperature is back within the valid range. A status flag is provided in the telemetry line indicating when shutter lockout is in effect.

Figure 8 - FFC States

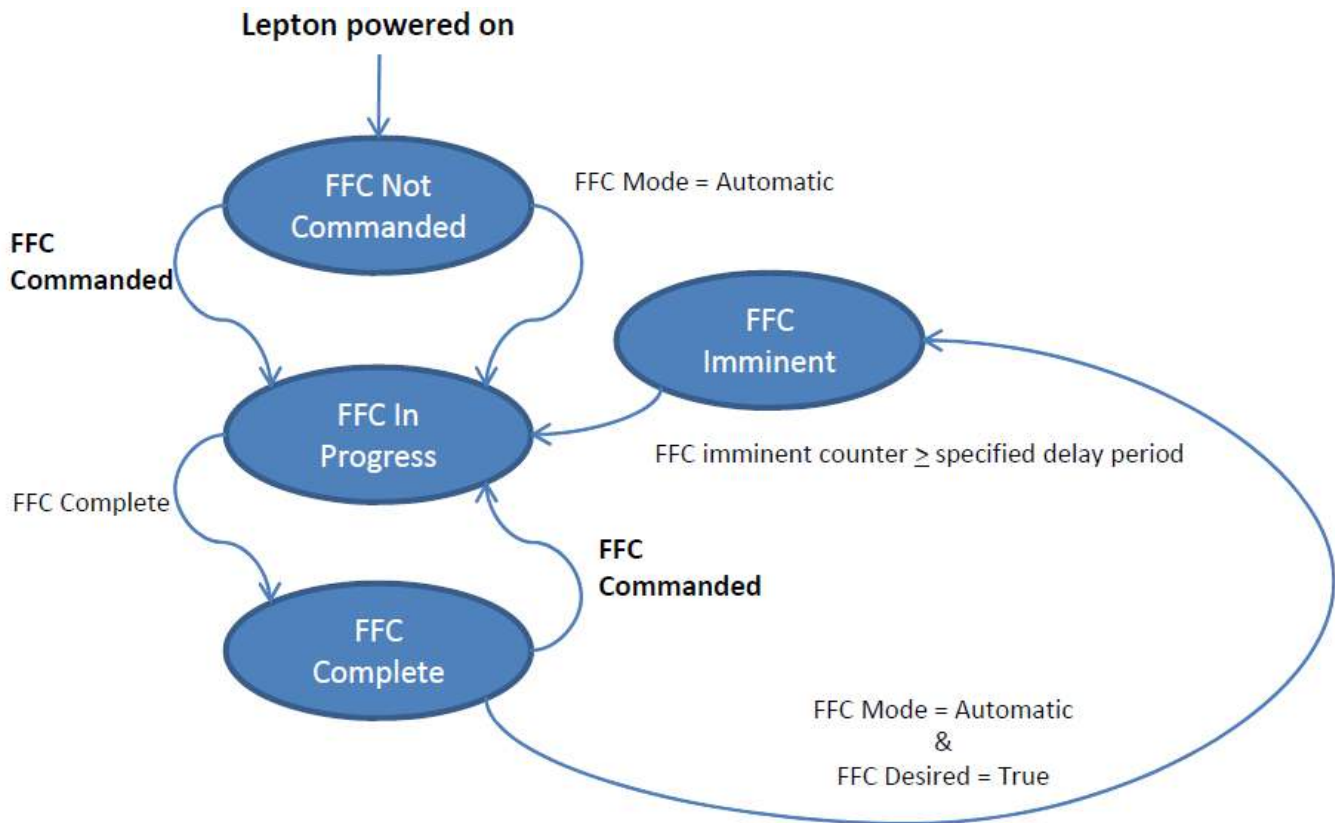

<sup>5</sup> Lepton 2.0 and 3.0 have an upper shutter lockout temperature set to 65 °C.

The information contained herein does not contain technology as defined by the EAR, 15 CFR 772, is publicly available, and therefore, not subject to EAR. NSR (6/14/2018).

Information on this page is subject to change without notice.

Lepton Engineering Datasheet, Document Number: 500-0659-00-09 Rev: 204



The World's Sixth Sense™

# FLIR LEPTON® Engineering Datasheet

Figure 9 - Relative Spatial Noise after FFC vs. Number of Integrated Frames ((defaults is 8)

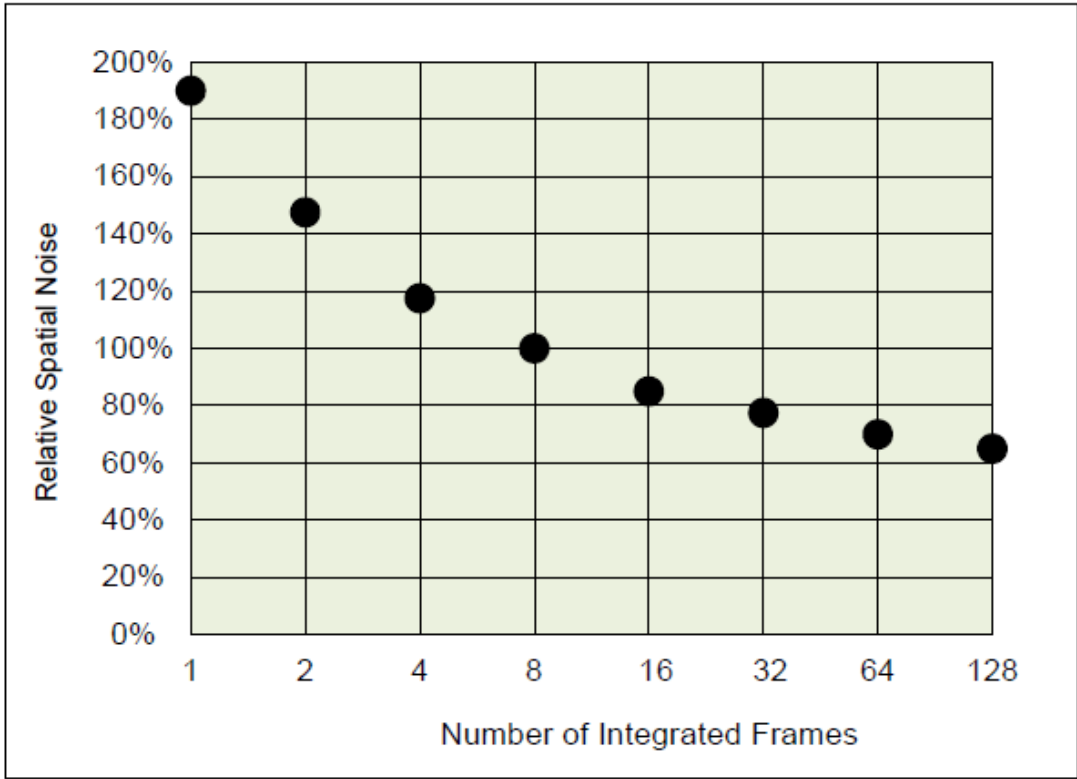

### 3.3 Gain States

Lepton 2.5 and 3.5 can be configured to operate in a high-gain state (the only available state in other versions of Lepton) or a low-gain state. The high gain state provides lower NEDT and lower intra-scene range and the low-gain state provides higher NEDT but achieves higher intra-scene range. Lepton provides three different gain-selection modes:

- **High (default)**
- **Low**
- **Automatic**

The information contained herein does not contain technology as defined by the EAR, 15 CFR 772, is publicly available, and therefore, not subject to EAR. NSR (6/14/2018).

Information on this page is subject to change without notice.

Lepton Engineering Datasheet, Document Number: 500-0659-00-09 Rev: 204



The World's Sixth Sense™

# FLIR LEPTON® Engineering Datasheet

---

In high gain mode, the camera operates in the high gain state only. In low gain mode, the camera operates in the low gain state only. In automatic gain mode, the camera software automatically selects between high and low gain states based on the scene conditions and the following user-selectable parameters:

- High-to-low temperature / high-to-low population: The camera transitions to low gain when a percentage of the pixel population greater than the user-defined population threshold is imaging a hotter scene temperature than the user-defined temperature threshold
- Low-to-high temperature / low-to-high population: The camera transitions to high gain when a percentage of the pixel population greater than the user-defined population threshold is imaging a colder scene temperature than the user-defined temperature threshold
- Gain mode ROI: region of interest used for the calculations used to determine whether the scene conditions (temperature and population) meet the criteria for a gain switch

Radiometry must be enabled to configure the camera software to automatic gain mode as scene temperature is used as the metric to determine the gain mode switching behaviour. Note that an FFC is required upon gain switch for uniformity and radiometric accuracy updates; therefore, the recommended FFC mode for automatic gain mode is automatic FFC. In automatic gain mode and external of manual FFC mode, the camera will transition to a different gain mode without an automatic FFC occurring and the user must initiate the FFC utilizing a telemetry bit (e.g. effective gain state or FFC desired) to determine when the switch occurred and an FFC is necessary.

## 3.4 Telemetry Modes

There are three telemetry modes that affect the video output signal:

- **Telemetry disabled (default)**
- **Telemetry as header**
- **Telemetry as footer**

Explicit commands over the CCI select each mode. The contents and encoding of the telemetry data are shown in [Table 2](#).

[Table 3](#) shows the encoding of the status bits (Telemetry Row A, Words 3 and 4).

The information contained herein does not contain technology as defined by the EAR, 15 CFR 772, is publicly available, and therefore, not subject to EAR. NSR (6/14/2018).

Information on this page is subject to change without notice.

Lepton Engineering Datasheet, Document Number: 500-0659-00-09 Rev: 204



The World's Sixth Sense™

# FLIR LEPTON® Engineering Datasheet

Table 2 - Telemetry Data Content and Encoding

Telemetry Row	Word start	Word End	Number of 16-bit Words	Name	Notes
A	0	0	1	Telemetry Revision	Format = major (byte 1), minor rev (byte 0).
A	1	2	2	Time Counter	32-bit counter in units of msec elapsed since boot-up
A	3	4	2	Status Bits	See <a href="#">Table 3</a>
A	5	12	8	Module serial #	
A	13	16	4	Software revision	
A	17	19	3	Reserved	
A	20	21	2	Frame Counter	32-bit counter of output frames
A	22	22	1	Frame Mean	
A	23	23	1	FPA Temp	In counts (prior to conversion to Kelvin)
A	24	24	1	FPA Temp	In Kelvin x 100
A	25	25	1	Housing Temp	In counts (prior to conversion to Kelvin) Lepton 2.5, 3.5
A	26	26	1	Housing Temp	In Kelvin x 100 Lepton 2.5, 3.5
A	27	28	2	Reserved	
A	29	29	1	FPA Temp at last FFC	Updated every FFC. Units are Kelvin x100

The information contained herein does not contain technology as defined by the EAR, 15 CFR 772, is publicly available, and therefore, not subject to EAR. NSR (6/14/2018).

Information on this page is subject to change without notice.

Lepton Engineering Datasheet, Document Number: 500-0659-00-09 Rev: 204



The World's Sixth Sense™



# FLIR LEPTON® Engineering Datasheet

Telemetry Row	Word start	Word End	Number of 16-bit Words	Name	Notes
A	30	31	2	Time Counter at last FFC	Updated every FFC. Units are msec
A	32	32	1	Housing temp at last FFC	Updated every FFC. Units are Kelvin x100. Lepton 2.5, 3.5
A	33	33	1	Reserved	
A	34	37	4	AGC ROI	(top, left, bottom, right)
A	38	38	1	AGC Clip-Limit High	See <a href="#">AGC</a> , page 15
A	39	39	1	AGC Clip-Limit Low	
A	40	71	32	Reserved	
A	72	73	2	Video Output Format	See <a href="#">Video Output Format Modes</a> , page 36
A	74	74	1	Log2 of FFC	See <a href="#">FFC States</a> , page 18
A	75	79	5	Reserved	
B	0	18	19	Reserved	
B	19	19	1	Emissivity	Scaled by 8192
B	20	20	1	Background Temperature	Temperature in Kelvin x 100
B	21	21	1	Atmospheric Transmission	Scaled by 8192
B	22	22	1	Atmospheric Temperature	Temperature in Kelvin x 100
B	23	23	1	Window Transmission	Scaled by 8192

The information contained herein does not contain technology as defined by the EAR, 15 CFR 772, is publicly available, and therefore, not subject to EAR. NSR (6/14/2018).

Information on this page is subject to change without notice.

Lepton Engineering Datasheet, Document Number: 500-0659-00-09 Rev: 204



The World's Sixth Sense™

# FLIR LEPTON® Engineering Datasheet

Telemetry Row	Word start	Word End	Number of 16-bit Words	Name	Notes
B	24	24	1	Window Reflection	Scaled by 8192
B	25	25	1	Window Temperature	Temperature in Kelvin x 100
B	26	26	1	Window Reflected Temperature	Temperature in Kelvin x 100
B	27	79	53	Reserved	
C	0	4	5	Reserved	
C	5	5	1	Gain Mode <sup>6</sup>	0 = High, 1 = Low, 2 = Auto
C	6	6	1	Effective Gain	In Auto mode, 0 = High, 1 = Low
C	7	7	1	Gain Mode Desired Flag	0 = current gain mode is desired, 1 = gain mode switch desired
C	8	8	1	Temperature Gain Mode Threshold High to Low (°C)	Temperature threshold in °C used to determine when an Auto switch to Low gain mode (while in High gain mode) should occur in Radiometry enabled/TLinear disabled mode
C	9	9	1	Temperature Gain Mode Threshold Low to High (°C)	Temperature threshold in °C used to determine when an Auto switch to High gain mode (while in Low gain mode) should occur in Radiometry enabled/TLinear disabled mode
C	10	10	1	Temperature Gain Mode Threshold High to Low (K)	Temperature threshold in Kelvin used to determine when an Auto switch to Low gain mode (while in High gain mode) should occur in TLinear mode

<sup>6</sup> See [Gain States](#), page 21.

The information contained herein does not contain technology as defined by the EAR, 15 CFR 772, is publicly available, and therefore, not subject to EAR. NSR (6/14/2018).

Information on this page is subject to change without notice.

Lepton Engineering Datasheet, Document Number: 500-0659-00-09 Rev: 204



The World's Sixth Sense™

# FLIR LEPTON® Engineering Datasheet

Telemetry Row	Word start	Word End	Number of 16-bit Words	Name	Notes
C	11	11	1	Temperature Gain Mode Threshold Low to High (K)	Temperature threshold in Kelvin used to determine when an Auto switch to High gain mode (while in Low gain mode) should occur in TLinear mode
C	12	13	2	Reserved	
C	14	14	1	Population Gain Mode Threshold High to Low	Population threshold in percent of the Gain Mode ROI used to determine when an Auto switch to Low gain mode (while in High gain mode) should occur
C	15	15	1	Population Gain Mode Threshold Low to High	Population threshold in percent of the Gain Mode ROI used to determine when an Auto switch to High gain mode (while in Low gain mode) should occur
C	16	21	6	Reserved	
C	22	25	4	Gain Mode ROI	(startRow, startCol, endRow, endCol)
C	26	47	22	Reserved	
C	48	48	1	TLinear Enable State	True if enabled
C	49	49	1	TLinear	T-Linear resolution (0 = 0.1, 1 = 0.01)
C	50	50	1	Spotmeter Mean	Spotmeter mean value in Kelvin within ROI
C	51	51	1	Spotmeter Maximum	Spotmeter max value in Kelvin within ROI
C	52	52	1	Spotmeter Minimum	Spotmeter min value in Kelvin within ROI
C	53	53	1	Spotmeter Population	Number of pixel in Spotmeter ROI

The information contained herein does not contain technology as defined by the EAR, 15 CFR 772, is publicly available, and therefore, not subject to EAR. NSR (6/14/2018).

Information on this page is subject to change without notice.

Lepton Engineering Datasheet, Document Number: 500-0659-00-09 Rev: 204



The World's Sixth Sense™

# FLIR LEPTON® Engineering Datasheet

Telemetry Row	Word start	Word End	Number of 16-bit Words	Name	Notes
C	54	54	1	Spotmeter ROI Start Row	Spotmeter ROI starting row coordinate
C	55	55	1	Spotmeter ROI Start Col	Spotmeter ROI starting column coordinate
C	56	56	1	Spotmeter ROI End Row	Spotmeter ROI ending row coordinate
C	57	57	1	Spotmeter ROI End Col	Spotmeter ROI ending column coordinate
C	58	79	22	Reserved	

The information contained herein does not contain technology as defined by the EAR, 15 CFR 772, is publicly available, and therefore, not subject to EAR. NSR (6/14/2018).

Information on this page is subject to change without notice.

Lepton Engineering Datasheet, Document Number: 500-0659-00-09 Rev: 204



The World's Sixth Sense™

# FLIR LEPTON® Engineering Datasheet

Table 3 - Status Bit Encoding (Telemetry Row A, words 3 and 4)

Bit start	Bit end	Number of Bits	Name	Notes
0	2	3	Reserved	
3	3	1	FFC Desired <sup>7</sup>	0 = FFC not desired 1 = FFC desired
4	5	2	FFC State <sup>7</sup>	00 = FFC never commanded 01 = FFC imminent 10 = FFC in progress 11 = FFC complete
6	11	6	Reserved	
12	12	1	AGC State	0=Disabled 1=Enabled
13	14	2	Reserved	
15	15	1	Shutter lockout <sup>7</sup>	0 = Shutter not locked out 1 = Shutter locked out (outside of valid temperature range, -10°C to 80°C) <sup>8</sup>
16	19	4	Reserved	
20	20	1	Overtemp shut down imminent	Goes true 10 seconds before shutdown (see <a href="#">Power States</a> , page 15)
21	31	11	Reserved	

## 3.5 Radiometry Modes

The Lepton with Radiometry (2.5 and 3.5) includes multiple options for radiometry modes that affect the video output signal:

<sup>7</sup> See [FFC States](#), page 21.

<sup>8</sup> Lepton 2.0 and 3.0 have an upper shutter lockout temperature set to 65 °C.

The information contained herein does not contain technology as defined by the EAR, 15 CFR 772, is publicly available, and therefore, not subject to EAR. NSR (6/14/2018).

Information on this page is subject to change without notice.

Lepton Engineering Datasheet, Document Number: 500-0659-00-09 Rev: 204



The World's Sixth Sense™

# FLIR LEPTON® Engineering Datasheet

---

- Radiometry enabled, TLinear enabled (default for Lepton 2.5 and 3.5)
- Radiometry enabled, TLinear disabled
- Radiometry disabled

## 3.5.1 Radiometry Enabled - TLinear

The radiometry enabled mode affects the transfer function between incident flux (scene temperature) and pixel output. From an image-quality standpoint, both radiometry modes produce nearly identical performance (no change in NEDT), and either mode is appropriate for strict imaging applications. However, for applications in which temperature measurement is required, radiometry must be enabled to access the related calibration and software features, such as TLinear and Spotmeter, which support these measurements. In radiometry enabled mode, enabling the corresponding TLinear mode changes the pixel output from representing scene flux in 14-bit digital counts to representing scene temperature values in Kelvin (multiplied by a scale factor to include decimals). For example, with TLinear mode enabled with a resolution of 0.01, a pixel value of 30000 signifies that the pixel is measuring 26.85°C (300.00K – 273.15K). The Lepton with Radiometry configuration is intended as a fully radiometric camera; therefore, the factory defaults are defined to have both radiometry and TLinear modes enabled.

With radiometry mode enabled (independent of TLinear state), the Spotmeter feature can be utilized. The Spotmeter returns the mean, maximum, and minimum temperature readings in Kelvin for a given frame and ROI via the CCI and/or telemetry. The ROI coordinates are user-selectable via CCI to allow for readings confined to any arbitrary size or location within the array.

The radiometric accuracy over the operational temperature range is typically within  $\pm 5^{\circ}\text{C}$  or 5%. Integration into an end-system and environment and/or scene differences can affect the radiometric performance. To address these factors, user-configurable parameters are available in software to account for the difference between calibration method at the factory and the final system and application. The parameters include scene emissivity, atmospheric temperature and transmission, background temperature, and parameters to account for the recommended window included on a fully integrated system (transmission, reflection, temperature, and reflected temperature). For a more detailed discussion on radiometry principles, accuracy, and calibration, reference the Radiometry Application Note.

Note that the following discussion assumes AGC is disabled (see [AGC Modes](#), page 34). If AGC is enabled, the differences between the two radiometry modes are completely obscured by the AGC algorithm. In other words, with AGC enabled, any differences in signal output between radiometry-disabled and radiometry-enabled modes are negligible.

## 3.5.2 Radiometry Enabled – Flux linear

The information contained herein does not contain technology as defined by the EAR, 15 CFR 772, is publicly available, and therefore, not subject to EAR. NSR (6/14/2018).

Information on this page is subject to change without notice.

Lepton Engineering Datasheet, Document Number: 500-0659-00-09 Rev: 204



The World's Sixth Sense™

# FLIR LEPTON® Engineering Datasheet

With radiometry enabled, Lepton performs internal adjustments to the signal level such that in principle the output is independent of the camera's own temperature. The resulting output for three different scene temperatures is illustrated hypothetically in [Figure 10](#). Notice in [Figure 10](#) that the output is only a function of scene temperature, not camera temperature (again, the figure is for illustration purposes only and not perfectly representative. In practice, there is slight output variation as camera temperature changes, particularly when the temperature change is rapid). Also notice that responsivity is also independent of camera temperature; that is, the difference in output between two different scene temperatures is a constant, as opposed to in [Figure 11](#) on page [32](#), where it decreases with increasing camera temperature.

**Figure 10 - Hypothetical Illustration of Camera Output in counts vs. Camera Temperature in Radiometry-enabled Mode**

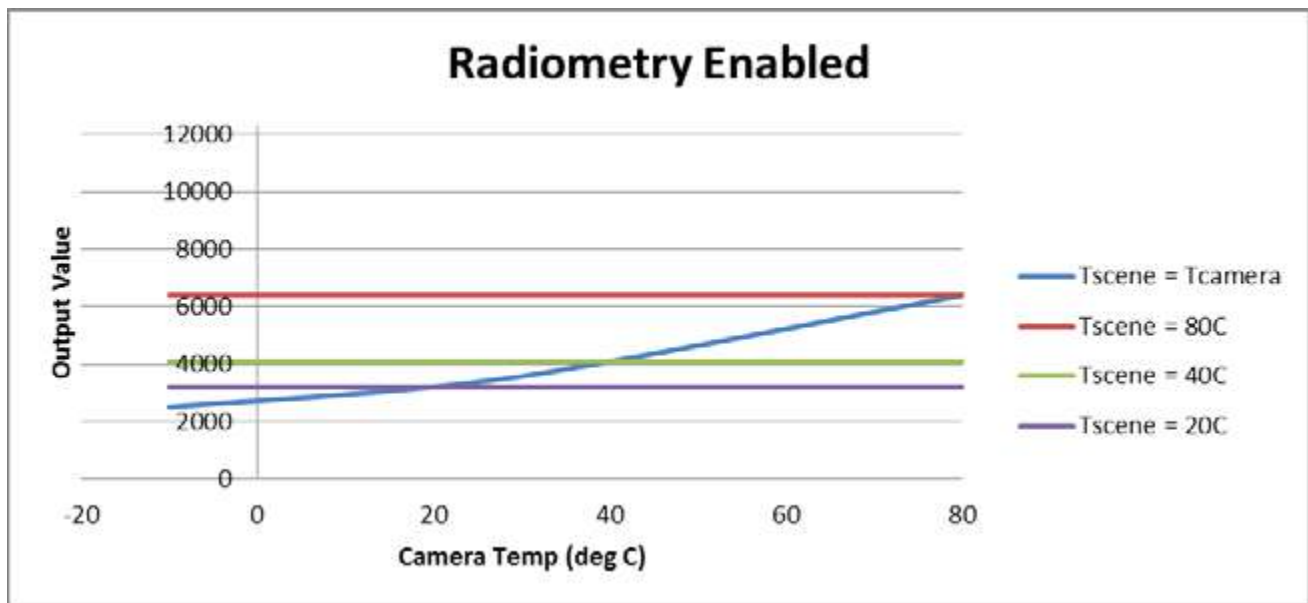

### 3.5.3 Radiometry Disabled

With radiometry disabled, the output of a given pixel is intended to be in the lower quarter of the 14-bit range (~4096) when viewing a scene with a temperature equal to the temperature of the camera.<sup>9</sup> Furthermore, the responsivity, which is defined as the change in pixel output value for a change in scene temperature, varies over

<sup>9</sup> With Lepton 1.5, 1.6, 2.0 and 3.0, the output was intended to be in the middle of the 14-bit range (~8192) but was updated to provide more scene dynamic range at the hotter end of the spectrum for the radiometric release.

The information contained herein does not contain technology as defined by the EAR, 15 CFR 772, is publicly available, and therefore, not subject to EAR. NSR (6/14/2018).

Information on this page is subject to change without notice.

Lepton Engineering Datasheet, Document Number: 500-0659-00-09 Rev: 204



The World's Sixth Sense™

# FLIR LEPTON® Engineering Datasheet

the camera's operating temperature range. The resulting output for three different scene temperatures is illustrated hypothetically in [Figure 11](#) (note that the figure is for illustration purposes and not perfectly representative).

**Figure 11 - Hypothetical Illustration of Camera Output vs. Camera Temperature in Radiometry-disabled Mode**

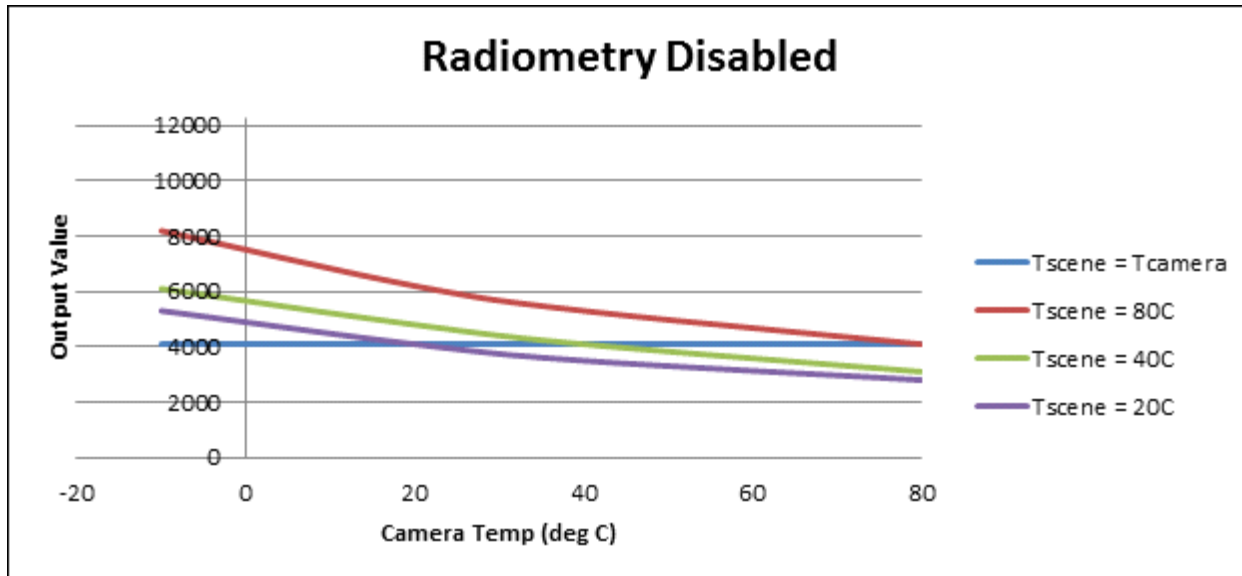

### 3.5.4 Radiometric Accuracy – Module

Lepton camera module radiometric accuracy in high gain mode is  $\pm 5^{\circ}\text{C}$  @  $25^{\circ}\text{C}$  against a  $35^{\circ}\text{C}$  blackbody for a Lepton camera module (using a simple test board with no significant heat sources) at equilibrium and 1" blackbody at 25cm, corrected for emissivity, and in a normal room environment. In high gain mode the intra-scene temperature range is typically  $-10^{\circ}\text{C}$  to  $140^{\circ}\text{C}$ .

Lepton camera module radiometric accuracy in low gain mode is  $\pm 10^{\circ}\text{C}$  @  $25^{\circ}\text{C}$  against a  $35^{\circ}\text{C}$  blackbody for a Lepton camera module (using a simple test board with no significant heat sources) at equilibrium and 1" blackbody at 25cm, corrected for emissivity, and in a normal room environment. In low gain mode the intra-scene temperature range is typically  $-10^{\circ}\text{C}$  to  $450^{\circ}\text{C}$  (or  $400^{\circ}\text{C}$  for Lepton 3.5).

### 3.5.5 Radiometric Accuracy – System Considerations

The information contained herein does not contain technology as defined by the EAR, 15 CFR 772, is publicly available, and therefore, not subject to EAR. NSR (6/14/2018).

Information on this page is subject to change without notice.

Lepton Engineering Datasheet, Document Number: 500-0659-00-09 Rev: 204



The World's Sixth Sense™



# FLIR LEPTON® Engineering Datasheet

The radiometric accuracy of the Lepton camera module depends primarily on the ambient and scene temperature. The size, distance, and emissivity of the target are also factors. Extreme humidity, high concentrations of certain gases such as CO<sub>2</sub>, and nearby extremely hot or cold objects may also affect measurements and should be avoided during module tests. When measured against a 1” blackbody at 25cm, corrected for target emissivity, and at thermal equilibrium under typical room conditions, the typical accuracy of the Lepton module in high gain mode is per [Table 4](#).

**Table 4- Radiometric Accuracy over Conditions, High Gain**

		T Ambient		
		0°C	30°C	60°C
T Scene	10°C	±7°C	±7°C	±8°C
	50°C	±6°C	±5°C	±5°C
	100°C	±6°C	±5°C	±4°C

When the Lepton module is integrated into a system, there are additional error sources that must be considered. Heat from nearby components such as electronic devices, motors and solenoids, and even heat from an operator’s hand, may directly or indirectly increase the radiation falling on the sensor. Variable heat sources should be avoided. It is important that the heat presented to the Lepton module from surrounding electronics and other sources be consistent and symmetric about the Lepton module to make compensation effective. The correction parameters are scalar values and cannot accommodate dynamic or gradient effects. In addition, when a protective window is required, reductions of the amount of scene radiation from the window as well as direct emissions and reflections from it, will alter the received radiation. The Lepton module provides methods to correct for these effects.

When the Lepton camera module is used in a device with a protective window and surrounding heat sources, the radiometric temperature reading can be improved by performing a gain and offset correction for best accuracy. The gain and offset values are input as window transmission and window temperature parameters through the CCI interface. After performing a recalibration at room temperature against two reference blackbodies and programming these two parameters, the typical accuracy in high gain mode can be according to

**Table 5.**

The information contained herein does not contain technology as defined by the EAR, 15 CFR 772, is publicly available, and therefore, not subject to EAR. NSR (6/14/2018).

Information on this page is subject to change without notice.

Lepton Engineering Datasheet, Document Number: 500-0659-00-09 Rev: 204



The World’s Sixth Sense™

# FLIR LEPTON® Engineering Datasheet

Table 5 - Typical Radiometric Accuracy after Per Unit Calibration.

		T Ambient		
		0°C	30°C	60°C
T Scene	10°C	±5°C	±5°C	±6°C
	50°C	±5°C	±3°C	±3°C
	100°C	±5°C	±4°C	±3°C

A protective window will also affect intra-scene temperature range. Any environmental or system factors that reduce the flux received by the sensor will lower the lower limit, and raise the upper limit, of the range. Such factors will also decrease sensitivity and possibly even accuracy, so should normally be kept to a minimum.

### 3.6 AGC Modes

There are two AGC modes:

- **AGC disabled (default)**
- **AGC enabled** (see AGC HEQ Output Scale Factor and AGC Calculation Enable State in the Software IDD for additional, related options)

AGC is a process whereby the large dynamic range of the infrared sensor is collapsed to a range more appropriate for a display system. For Lepton, this is a 14-bit to 8-bit conversion. In its most simplistic form, AGC can be a linear mapping from 14-bit to 8-bit; however, a simple linear AGC is generally incapable of providing pleasing imagery in all imaging conditions. For example, when a scene includes both cold and hot regions (for example, a hot object in front of a cold background as illustrated in [Figure 13](#)), linear AGC can produce an output image in which most pixels are mapped to either full black or full white with very little use of the gray-shades (8-bit values) in between. Because of this limitation of linear AGC, a more sophisticated algorithm is preferred.

Similar to most AGC algorithms that optimize the use of gray-shades, Lepton's is histogram-based. Essentially a histogram counts the number of pixels in each frame that have a given 14-bit value. [Figure 12](#) illustrates the concept for a 3x3 pixel area.

The information contained herein does not contain technology as defined by the EAR, 15 CFR 772, is publicly available, and therefore, not subject to EAR. NSR (6/14/2018).

Information on this page is subject to change without notice.

Lepton Engineering Datasheet, Document Number: 500-0659-00-09 Rev: 204



The World's Sixth Sense™

# FLIR LEPTON® Engineering Datasheet

Figure 12 - Illustration of a Histogram for a 3x3 Pixel Area

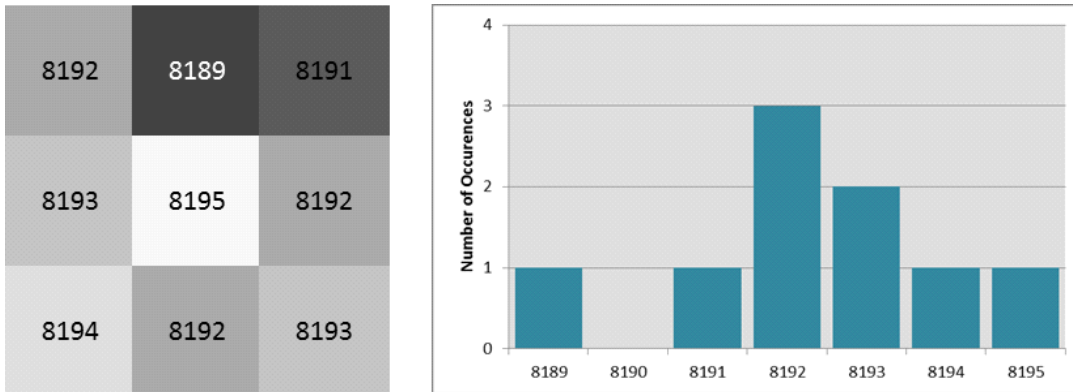

Classic histogram equalization uses the cumulative histogram as a mapping function between 14-bit and 8-bit. The intent is to devote the most gray-shades to those portions of the input range occupied by the most pixels. For example, an image consisting of 60% sky devotes 60% of the available gray-shades to the sky, leaving only 40% for the remainder of the image. By comparison, linear AGC “wastes” gray-shades when there are gaps in the histogram, whereas classic histogram equalization allocates no gray-shades to the gaps. This behavior is in principle an efficient use of the available gray-shades, but there are a few drawbacks:

- The resulting contrast between an object and a much colder (or hotter) background can be rendered poor by the fact the algorithm “collapses” the separation between such that the object is only 1 gray-shade above the background. This phenomenon is illustrated in [Figure 13](#).
- Too much emphasis can be placed on background clutter, particularly when a mostly isothermal background comprises a large fraction of the total image area. This is also illustrated in [Figure 15](#).
- For scenes with low dynamic range or less content, both the Linear AGC and Classic HEQ algorithms allow the application of a high amount of gain to the histogram, resulting in more contrast but increasing noise.

The Lepton AGC algorithm is a modified version of classic histogram equalization that mitigates these shortcomings. One such modification is a parameter called “clip limit high.” It clips the maximum population of any single bin, limiting the influence of heavily populated bins on the mapping function. Another parameter utilized by the Lepton algorithm is called “clip limit low.” It adds a constant value to every non-zero bin in the histogram, resulting in additional contrast between portions of the histogram separated by gaps. [Figure 13](#) is an example showing the benefit of the Lepton clip parameters.

The information contained herein does not contain technology as defined by the EAR, 15 CFR 772, is publicly available, and therefore, not subject to EAR. NSR (6/14/2018).

Information on this page is subject to change without notice.

Lepton Engineering Datasheet, Document Number: 500-0659-00-09 Rev: 204



The World's Sixth Sense™

# FLIR LEPTON® Engineering Datasheet

Figure 13 - Comparison of Linear AGC and Classic/Lepton Variant of Histogram Equalization

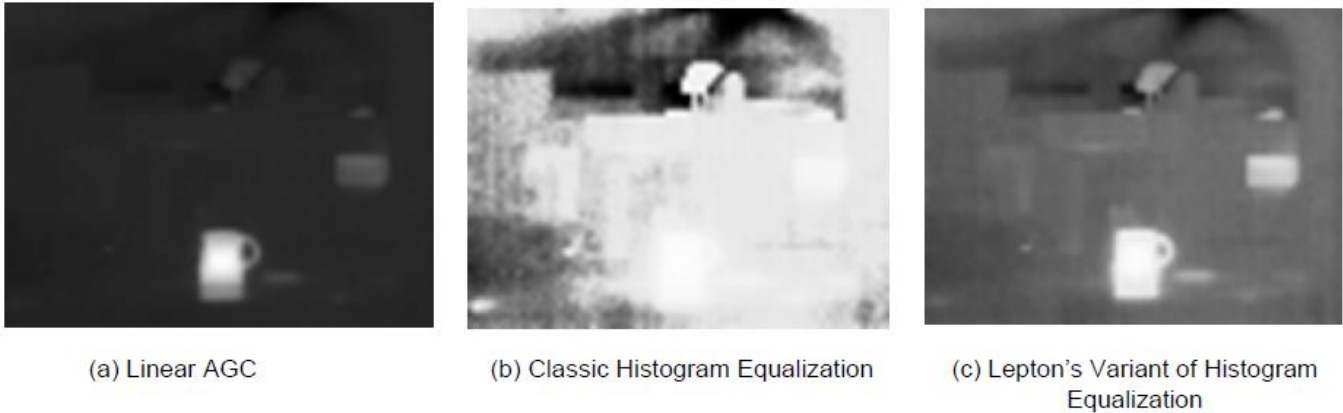

A high value of clip limit high results in a mapping more like classic histogram equalization, whereas a low value results in mapping more like linear AGC. For clip limit low, the opposite is true: a high value results in a mapping more like linear AGC, whereas a low value results in a mapping more like classic histogram equalization. There may be some overlap between the two parameters, but the difference between the two is that lowering the clip limit high linearizes the brightness levels of the objects in the scene, while raising the clip limit low makes the brightness of objects in the scene more representative of their temperature differences. The default values of both parameters produce a good compromise between the two; however, because optimum AGC is highly subjective and often application dependent, customers are encouraged to experiment to find settings most appropriate for the target application.

By default, the histogram used to generate Lepton's 14-bit to 8-bit mapping function is collected from the full array. In some applications, it is desirable to have the AGC algorithm ignore a portion of the scene when collecting the histogram. For example, in some applications it may be beneficial to optimize the display to a region of interest (ROI) in the central portion of the image. When the AGC ROI is set to a subset of the full image, any scene content located outside of the ROI is not included in the histogram and therefore does not affect the mapping function (note: this does not mean the portion outside of the ROI is not displayed or that AGC is not applied there, only that those portions outside the AGC ROI do not influence the mapping function).

### 3.7 Video Output Format Modes

There are two video-output format modes:

The information contained herein does not contain technology as defined by the EAR, 15 CFR 772, is publicly available, and therefore, not subject to EAR. NSR (6/14/2018).

Information on this page is subject to change without notice.

Lepton Engineering Datasheet, Document Number: 500-0659-00-09 Rev: 204



The World's Sixth Sense™

# FLIR LEPTON® Engineering Datasheet

---

- **Raw14 (default)**<sup>10</sup>
- **RGB888**

The first mode is appropriate for viewing 14-bit data (AGC disabled), 16-bit TLinear data (AGC disabled, TLinear enabled), or 8-bit data (AGC enabled) without colorization. The second mode is for viewing data after application of the colorization look-up table (LUT) to generate 24-bit RGB data. This capability is further described below. Note that the two output format modes result in different packet sizes for the VoSPI output data (see [VoSPI Protocol](#) page 46). To properly view RGB888 data, the following order of operations should be followed:

1. Disable telemetry if required (telemetry is not valid in RGB888 mode)
2. Enable AGC (colorization without AGC is not a valid permutation)
3. Select RGB888 mode
4. Synchronize or re-synchronize the VoSPI channel (see [Establishing/Re-Establishing Sync](#), page 52)
5. Optional: Select a desired built-in LUT or upload a custom LUT.

The purpose of RGB888 mode is to generate a “false color” RGB image in which each grayscale value is converted by means of a user-specified look-up table (typically called a color palette) to a particular color. [Figure 14](#) shows the 8 built-in color palettes provided in the current release of Lepton, and [Figure 15](#) shows an example image with a color palette applied. The built-in color palettes are selectable by means of the command and control interface (see the Lepton Software Interface Description Document for more information on the palette format). Additionally, a user-specified palette can be uploaded through the command and control interface.

---

<sup>10</sup> Raw14 is a mode with 16 bits per pixel of which the two most significant bits are zero, except in TLinear mode, when available.

The information contained herein does not contain technology as defined by the EAR, 15 CFR 772, is publicly available, and therefore, not subject to EAR. NSR (6/14/2018).

Information on this page is subject to change without notice.

Lepton Engineering Datasheet, Document Number: 500-0659-00-09 Rev: 204



The World's Sixth Sense™

# FLIR LEPTON® Engineering Datasheet

Figure 14 - Built-in Color Palette

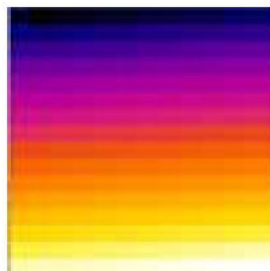

The upper left corner represents the color associated with an 8-bit input value of 0. The lower right corner represents the color associated with an input value of 255.



(a) Wheel 6

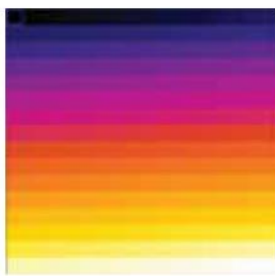

(b) Fusion (default)



(c) Rainbow

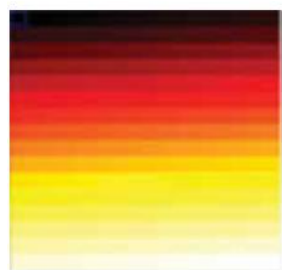

(d) Globow



(e) Sepia



(f) Color



(g) Ice Fire



(h) Rain

The information contained herein does not contain technology as defined by the EAR, 15 CFR 772, is publicly available, and therefore, not subject to EAR. NSR (6/14/2018).

Information on this page is subject to change without notice.

Lepton Engineering Datasheet, Document Number: 500-0659-00-09 Rev: 204



The World's Sixth Sense™

# FLIR LEPTON® Engineering Datasheet

---

Figure 15 - Comparison of an Identical Image with Grayscale and a False-color Palette

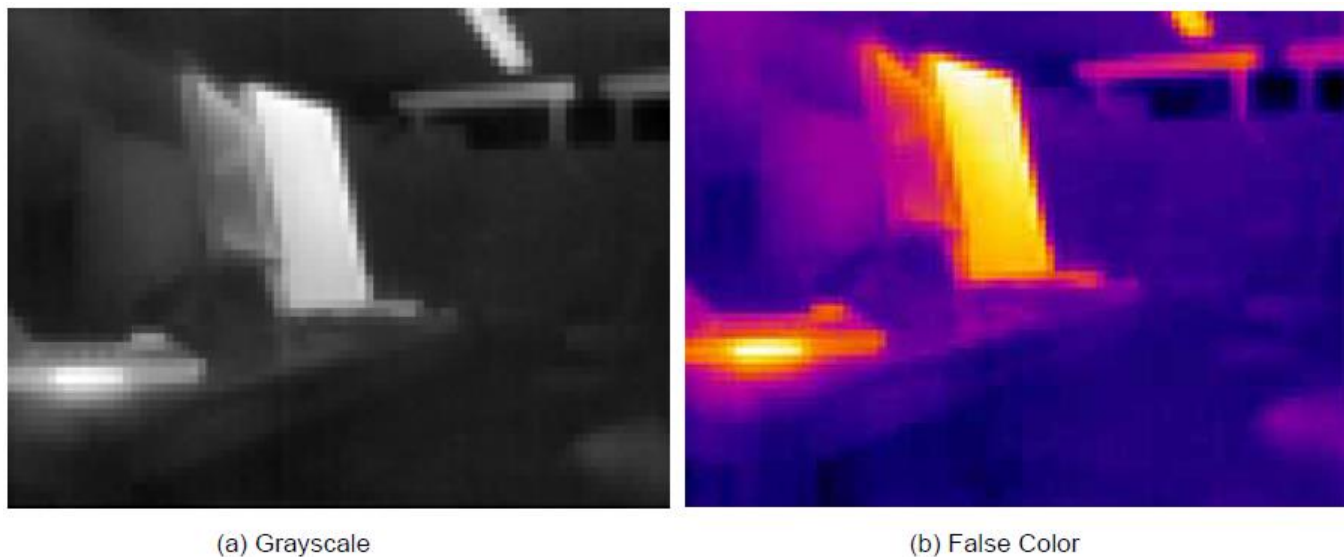

## 3.8 GPIO Modes

There are two supported GPIO modes:

- **Disabled (default)**
- **VSYNC enabled**

In disabled mode, no signals are provided as input or output on the GPIO pins. In VSYNC mode, a video sync signal is provided as an output on GPIO3. The purpose of this signal is more fully described in [Frame Synchronization](#), page 53.



**NOTE:** GPIO0, GPIO1, and GPIO2 should not be connected, regardless of the selected GPIO mode.

---

The information contained herein does not contain technology as defined by the EAR, 15 CFR 772, is publicly available, and therefore, not subject to EAR. NSR (6/14/2018).

Information on this page is subject to change without notice.

Lepton Engineering Datasheet, Document Number: 500-0659-00-09 Rev: 204



The World's Sixth Sense™

# FLIR LEPTON® Engineering Datasheet

## 4 Interface Descriptions

### 4.1 Command and Control Interface

Lepton provides a command and control interface (CCI) via a two-wire interface similar to I2C (the only difference relative to the true I2C standard is that all Lepton registers are 16 bits wide and consequently, only 16-bit transfers are allowed). The CCI address is 0x2A. The interface is described in detail in a separate document, the Lepton Software Interface Description Document (IDD), FLIR document #110-0144-04. Generally speaking, all commands issued through the CCI take the form of a “get” (reading data), a “set” (writing data), or a “run” (executing a function). **Table 6** shows a partial list of parameters / features controllable through the CCI. Note that the “Power-On Default” field in the table is not always equivalent to the software default described in the Software IDD as some of the parameters are explicitly configured at the factory for the applicable end use-case. For example, Lepton 2.5 and 3.5 are radiometric cameras, and therefore the power-on defaults include Radiometry state enabled, TLinear state enabled, and TLinear resolution of 0.01.

**Table 6 - Partial List of Parameters Controllable through the CCI**

Parameter	Power-On	Section in this document	Telemetry Line Location
AGC Mode	Disabled	<a href="#">AGC Modes, page 34</a>	A3-4
AGC ROI <sup>12</sup>	(0,0,79,59) or (0,0,159,119)	<a href="#">AGC Modes, page 34</a>	A34-A37
AGC Dampening Factor	64	<a href="#">AGC Modes, page 34</a>	A42
AGC Clip Limit High <sup>12</sup>	4800, 19200	<a href="#">AGC Modes, page 34</a>	A38
AGC Clip Limit Low	512	<a href="#">AGC Modes, page 34</a>	A39
SYS Telemetry Mode	Disabled	<a href="#">Telemetry Modes, page 23</a>	n/a
SYS Telemetry Location	Footer	<a href="#">Telemetry Modes, page 23</a>	n/a
SYS Number of Frames to Average	8	<a href="#">FFC States, page 18</a>	A74
SYS Gain Mode	High	<a href="#">Gain States, page 22</a>	B5

The information contained herein does not contain technology as defined by the EAR, 15 CFR 772, is publicly available, and therefore, not subject to EAR. NSR (6/14/2018).

Information on this page is subject to change without notice.

Lepton Engineering Datasheet, Document Number: 500-0659-00-09 Rev: 204



The World's Sixth Sense™



# FLIR LEPTON® Engineering Datasheet

Parameter	Power-On	Section in this document	Telemetry Line Location
SYS Gain Mode Object <sup>12,11</sup> (startRow, startCol, endRow, endCol)	(0,0,59,79) or (0,0,119,169): GainROI 25: P_hi_to_lo 90: P_lo_to_hi 115: C_hi_to_lo 85: C_lo_to_hi 388: T_hi_to_lo	<a href="#">Gain States</a> , page 22	B8-26
VID Color LUT Select	Fusion	<a href="#">Video Output Format Modes</a> , page 36	n/a
VID User Color LUT Upload / Download	n/a	<a href="#">Video Output Format Modes</a> , page 36	n/a
OEM FFC	n/a	<a href="#">FFC States</a> , page 18	A3-4
OEM Video Output Format	Raw14	<a href="#">Video Output Format Modes</a> , page 36	A3-4
OEM GPIO Mode	Disabled	<a href="#">GPIO Modes</a> , page 39	n/a
OEM GPIO VSYNC Phase Delay	0 lines	<a href="#">Frame Synchronization</a> , page 53	n/a
RAD Radiometry Control	Enabled	<a href="#">Radiometry Modes</a> , page 29	n/a
RAD TLinear Enable State	Enabled	<a href="#">Radiometry Modes</a> , page 29	C48
RAD Tlinear Resolution	0.01	<a href="#">Radiometry Modes</a> , page 29	C49
RAD Spotmeter ROI	(29,30,39,40)	<a href="#">Radiometry Modes</a> , page 29	C54-57

<sup>11</sup> Note different order of row/col compared to other ROI.

The information contained herein does not contain technology as defined by the EAR, 15 CFR 772, is publicly available, and therefore, not subject to EAR. NSR (6/14/2018).

Information on this page is subject to change without notice.

Lepton Engineering Datasheet, Document Number: 500-0659-00-09 Rev: 204



The World's Sixth Sense™

# FLIR LEPTON® Engineering Datasheet

Parameter	Power-On	Section in this document	Telemetry Line Location
RAD Spotmeter Value	N/A	<a href="#">Radiometry Modes</a> , page 29	C50-53
RAD Flux Linear Parameters	(8192, 29515, 8192, 29515, 8192, 29515, 0, 29515)	<a href="#">Radiometry Modes</a> , page 29	B19-26

## 4.1.1 User Defaults Feature

The user defaults feature allows the user to write desired operational defaults, such as those described in the CCI above, to OTP such that an initialization sequence is not necessary at start-up. The “OEM User Defaults” command is described in the Software IDD. The list of parameters that are included in the user defaults memory location are described in [Table 7](#).

**Table 7 - Parameters stored in the User Defaults OTP Memory Location**

Parameter	Power-On Default	Section in this document
AGC Mode	Disabled	<a href="#">AGC Modes</a> , page 34
AGC ROI <sup>12</sup> (startCol, startRow, endCol, endRow)	(0,0,79,59) or (0,0,159,119)	<a href="#">AGC Modes</a> , page 34
AGC Dampening Factor	64	<a href="#">AGC Modes</a> , page 34
AGC Clip Limit High <sup>12</sup>	4800, 19200	<a href="#">AGC Modes</a> , page 34
AGC Clip Limit Low	512	<a href="#">AGC Modes</a> , page 34
SYS Telemetry Mode	Disabled	<a href="#">Telemetry Modes</a> , page 23
SYS Telemetry Location	Footer	<a href="#">Telemetry Modes</a> , page 23
SYS Number of Frames to Average	8	<a href="#">FFC States</a> , page 18

<sup>12</sup> First set of coordinates refer to Lepton 1.5, 1.6, 2.0 and 2.5. The second set refers to Lepton 3.0 and 3.5.

The information contained herein does not contain technology as defined by the EAR, 15 CFR 772, is publicly available, and therefore, not subject to EAR. NSR (6/14/2018).

Information on this page is subject to change without notice.

Lepton Engineering Datasheet, Document Number: 500-0659-00-09 Rev: 204



The World's Sixth Sense™

# FLIR LEPTON® Engineering Datasheet

Parameter	Power-On Default	Section in this document
SYS Scene Stats ROI <sup>12</sup> (startCol, startRow, endCol, endRow)	(0,0,79,59) or (0,0,159,119)	
SYS FFC Mode	Auto	<a href="#">FFC States, page 18</a>
SYS FFC Period	180000	<a href="#">FFC States, page 18</a>
SYS FFC Temp Delta	150	<a href="#">FFC States, page 18</a>
SYS Gain Mode	High	<a href="#">Gain States, page 22</a>
VID Color LUT Select	Fusion	<a href="#">Video Output Format Modes, page 36</a>
OEM Video Output Format	Raw14	<a href="#">Video Output Format Modes, page 36</a>
OEM GPIO Mode	Disabled	<a href="#">GPIO Modes, page 39</a>
OEM GPIO VSYNC Phase Delay	0 lines	<a href="#">Frame Synchronization, page 53</a>
RAD Radiometry Control	Enabled	<a href="#">Radiometry Modes, page 29</a>
RAD TLinear Enable State	Enabled	<a href="#">Radiometry Modes, page 29</a>
RAD TLinear Resolution	0.01	<a href="#">Radiometry Modes, page 29</a>
RAD Spotmeter ROI (startCol, startRow, endCol, endRow)	(29,39,30,40) or (59,79,60,80)	<a href="#">Radiometry Modes, page 29</a>
RAD Flux Linear Parameters	(8192, 29515, 8192, 29515, 8192, 29515, 0, 29515)	<a href="#">Radiometry Modes, page 29</a>

This feature is intended to be performed at the OEM’s factory, because it requires an additional voltage supply and pin connection that should not be connected in run-time operation. The Lepton module pin connection for the programming voltage is described in [Table 8](#) below, and the electrical specifications for the supply are defined in [Table 9](#) below.

The information contained herein does not contain technology as defined by the EAR, 15 CFR 772, is publicly available, and therefore, not subject to EAR. NSR (6/14/2018).

Information on this page is subject to change without notice.

Lepton Engineering Datasheet, Document Number: 500-0659-00-09 Rev: 204



The World’s Sixth Sense™

# FLIR LEPTON® Engineering Datasheet

Table 8 - Lepton Camera Module Pin Description for VPROG

Pin #	Pin Name	Signal Type	Signal Level	Description
17	VPROG	Power	5.9V	Supply for Programming to OTP (5.9V +/- 2%).

Table 9 - Electrical Specifications for VPROG

Symbol	Parameter	Min	Typ	Max	Units
VPROG	Programming Voltage (power for programming OTP)	5.79	5.9	6.01	Volts

## 4.2 VoSPI Channel

The Lepton VoSPI protocol allows efficient and verifiable transfer of video over a SPI channel. The protocol is packet-based with no embedded timing signals and no requirement for flow control. The host (master) initiates all transactions and controls the clock speed. Data can be pulled from the Lepton (the slave) at a flexible rate. This flexibility is depicted in [Figure 16](#), which shows the use of a relatively slow clock utilizing most of the available frame period as well as the use of a fast clock that bursts frame data. Once all data for a given frame is read, the master has the option to stop the clock and/or de-assert the chip select until the next available frame. Alternatively, the master can simply leave the clock and chip select enabled, in which case Lepton transmits discard packets until the next valid video data is available.

The information contained herein does not contain technology as defined by the EAR, 15 CFR 772, is publicly available, and therefore, not subject to EAR. NSR (6/14/2018).

Information on this page is subject to change without notice.

Lepton Engineering Datasheet, Document Number: 500-0659-00-09 Rev: 204



The World's Sixth Sense™

# FLIR LEPTON® Engineering Datasheet

Figure 16 - VoSPI Flexible Clock Rate

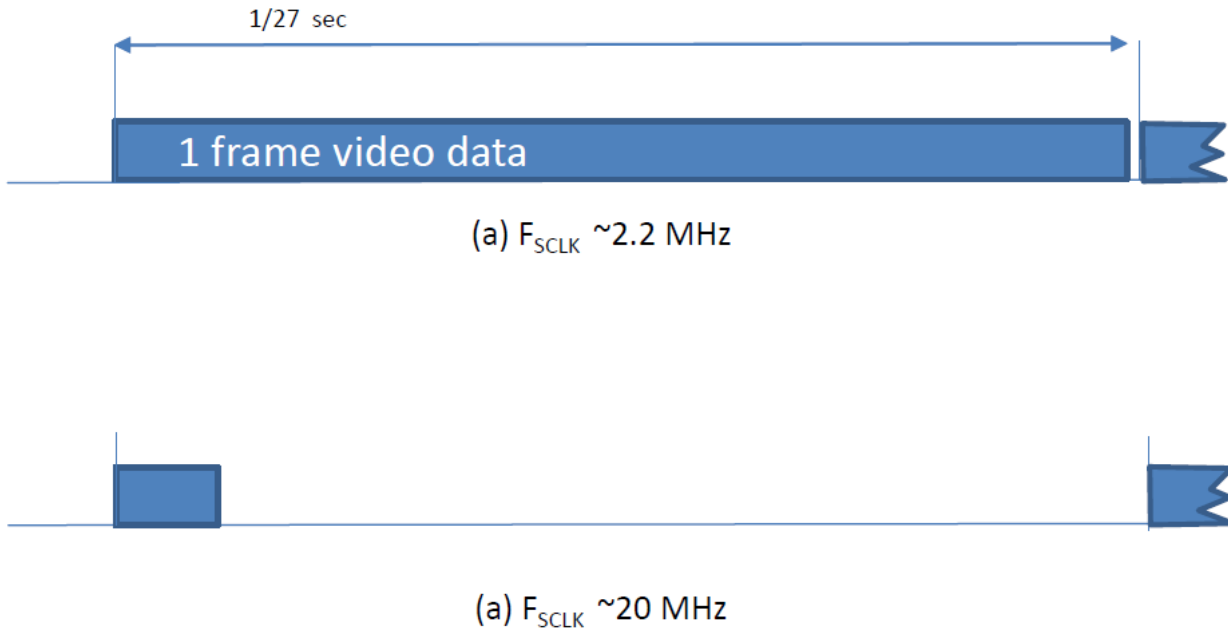

## 4.2.1 VoSPI Physical Interface

As illustrated in [Figure 17](#), VoSPI utilizes 3 of the 4 lines of a typical SPI channel:

- **SCK (Serial Clock)**
- **/CS (Chip Select, active low),**
- **MISO (Master In/Slave Out).**

Figure 17 - VoSPI I/O

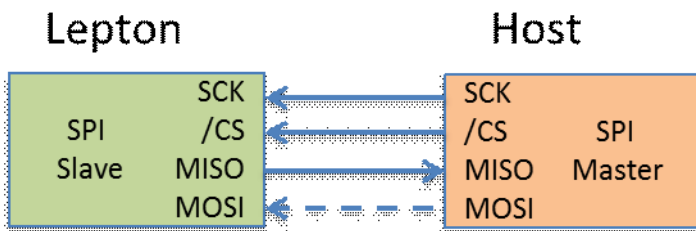

The information contained herein does not contain technology as defined by the EAR, 15 CFR 772, is publicly available, and therefore, not subject to EAR. NSR (6/14/2018).

Information on this page is subject to change without notice.

Lepton Engineering Datasheet, Document Number: 500-0659-00-09 Rev: 204



The World's Sixth Sense™

# FLIR LEPTON® Engineering Datasheet

The MOSI (Master Out/Slave In) signal is not currently employed and should be grounded or set low. Implementations are restricted to a single master and single slave. The Lepton uses SPI Mode 3 (CPOL=1, CPHA=1); SCK is HIGH when idle. Data is set up by the Lepton on the falling edge of SCK and should be sampled by the host controller on the rising edge. See [Figure 18](#). Data is transferred most-significant byte first and in big-endian order. [Figure 19](#) provides an example of the transmission of the value 0x8C08.

**Figure 18 - SPI Mode 3 (CPOL=1, CPHA=1)**

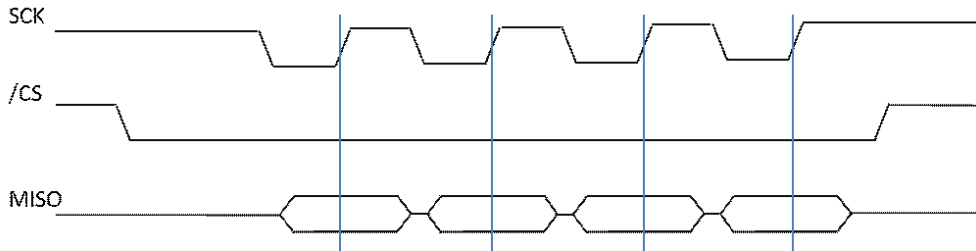

**Figure 19 - SPI Bit Order (transmission of 0x8C08)**

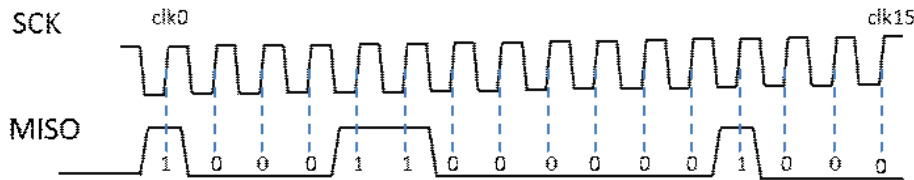

The maximum clock rate is 20 MHz. The minimum clock rate is a function of the number of bits of data per frame that need to be retrieved. As described in the sections that follow, the number of bits of data varies depending upon user settings (video format mode, telemetry mode). As an example, in Raw14 mode and telemetry disabled, there are 60 video packets per frame for an 80x60 array, each 1312 bits long, at approximately 26 frames per second. Therefore, the minimum rate is on the order of 2 MHz.

## 4.2.2 VoSPI Protocol – Lepton 1.5, 1.6, 2.0 and 2.5

VoSPI is built on a collection of object types as defined hierarchically below.

- **VoSPI Packet:** The Lepton VoSPI protocol is based on a single standardized VoSPI packet, the minimum “transaction” between master and slave. Each video packet contains data for a single video line or telemetry line. In addition to video packets, the VoSPI protocol includes discard packets that are provided when no video packets are available.

The information contained herein does not contain technology as defined by the EAR, 15 CFR 772, is publicly available, and therefore, not subject to EAR. NSR (6/14/2018).

Information on this page is subject to change without notice.

Lepton Engineering Datasheet, Document Number: 500-0659-00-09 Rev: 204



The World's Sixth Sense™

# FLIR LEPTON® Engineering Datasheet

- **VoSPI Frame:** A VoSPI frame is defined as a continuous sequence of VoSPI packets consisting of a full frame's worth of pixel data.
- **VoSPI Stream:** A VoSPI stream is defined as a continuous sequence of VoSPI frames.

As summarized in [Table 10](#), the packet length and number of packets per frame vary depending upon two runtime user selections, telemetry mode and bit resolution.

Telemetry mode:

- **Telemetry disabled (default)**
- **Telemetry enabled**

Video Format mode:

- **Raw14 (default)**
- **RGB888**

**Table 10 - Packet Length and Number of Video Packets per Frame as a Function of User Settings**

Video Format Mode	Telemetry Mode	
	Telemetry Disabled	Telemetry Enabled
Raw14	Packet length: 164 bytes Video packets per frame: 60	Packet length: 164 bytes Video packets per frame: 63
RGB888	Packet length: 244 bytes Video packets per frame: 60	N/A

### 4.2.2.1 VoSPI Packets

As depicted in [Figure 20](#), each packet contains a 4-byte header followed by either a 160-byte or 240-byte payload. Note: because the payload size differs between video formats, the setting should be selected before VoSPI synchronization is established. If the setting is changed while VoSPI is active, it is necessary to re-synchronize (see [VoSPI Stream](#), page 50).

**Figure 20 - Generic VoSPI Packet**

ID	CRC	Payload
----	-----	---------

The information contained herein does not contain technology as defined by the EAR, 15 CFR 772, is publicly available, and therefore, not subject to EAR. NSR (6/14/2018).

Information on this page is subject to change without notice.

Lepton Engineering Datasheet, Document Number: 500-0659-00-09 Rev: 204



The World's Sixth Sense™

# FLIR LEPTON® Engineering Datasheet

4 bytes	160 or 240 bytes (depending upon bit resolution setting)
---------	--

For video packets, the header includes a 2-byte ID and a 2-byte CRC. The ID field is a 12-bit packet number as shown in [Figure 21](#) (the leading 4 bits of the ID field are reserved and are not part of the packet number). Note that packet numbering restarts at zero on each new frame. The CRC portion of the packet header contains a 16-bit cyclic redundancy check (CRC), computed using the following polynomial:

$$x^{16} + x^{12} + x^5 + x^0$$

The CRC is calculated over the entire packet, including the ID and CRC fields. However, the four most-significant bits of the ID and all sixteen bits of the CRC are set to zero for calculation of the CRC. There is no requirement for the host to verify the CRC. However, if the host does find a CRC mismatch, it is recommended to re-synchronize the VoSPI stream to prevent potential misalignment.

**Figure 21 - Video Packet**

ID	CRC	Payload
xNNN (16 bits)	CRC (16 bits)	Video pixels for one video line

At the beginning of SPI video transmission until synchronization is achieved (see VoSPI Stream, page 41), and in the idle period between frames, Lepton transmits discard packets until it has a new frame from its imaging pipeline. As shown in [Figure 22](#), the 2-byte ID field for discard packets is always xFxx (where 'x' signifies a “don't care” condition). Note that VoSPI-enabled cameras do not have vertical resolution approaching 3840 lines (0xF00), and therefore it is never possible for the ID field in a discard packet to be mistaken for a video line.

**Figure 22 - Discard Packet**

ID	CRC	Payload
xFxx	xxxx	Discard data (same number of bytes as video packets)

For video packets, the payload contents depend upon the selected bit resolution.

The information contained herein does not contain technology as defined by the EAR, 15 CFR 772, is publicly available, and therefore, not subject to EAR. NSR (6/14/2018).

Information on this page is subject to change without notice.

Lepton Engineering Datasheet, Document Number: 500-0659-00-09 Rev: 204



The World's Sixth Sense™



# FLIR LEPTON® Engineering Datasheet

- For Raw14 mode (the default case), the payload is 160 bytes long. Excluding telemetry lines, each packet contains pixel data for all 80 pixels in a single video line.
  - With AGC disabled:
    - With 14-bit raw data the first two bits of each pixel's two-byte word are set to 0.
    - With TLinear output all 16 bits are used.
  - With AGC is enabled:
    - The first eight bits are set to 0.
- For RGB888 mode, the payload is 240 bytes long. Excluding telemetry lines (which are invalid in RGB mode), each packet consists of pixel data for a single video line (3 bytes per pixel).

Each case is illustrated in the following payload encoding figures.

**Figure 23 - Raw14 Mode: 1 video line per 160-byte payload**

Byte 0	Byte 1	Byte 2	Byte 3	...	Byte 158	Byte 159
Line m Pixel 0		Line m Pixel 1		...	Line m Pixel 79	

**Figure 24 - RGB888 Mode: 1 video line per 240-byte payload**

Byte 0	Byte 1	Byte 2	Byte 3	Byte 4	Byte 5	...	Byte 237	Byte 238	Byte 239
Line m Pixel 0 R	Line m Pixel 0 G	Line m Pixel 0 B	Line m Pixel 1 R	Line m Pixel 1 G	Line m Pixel 1 B	...	Line m Pixel 79 R	Line m Pixel 79 G	Line m Pixel 79 B

### 4.2.2.2 VoSPI Frames

A single Lepton frame contains data from all 60 or 120 rows of the sensor. However, the total number of video packets is not necessarily 60 or 120; the exact number depends upon user settings, specifically the telemetry mode (disabled, as header, or as footer). [Table 11](#) shows the number of packets per frame and the contents of each packet for all of the various combinations.

**Table 11 - Video Packet Contents Per Frame as a Function of Video Format and Telemetry-mode Settings**

	<b>Configuration</b>
--	----------------------

The information contained herein does not contain technology as defined by the EAR, 15 CFR 772, is publicly available, and therefore, not subject to EAR. NSR (6/14/2018).

Information on this page is subject to change without notice.

Lepton Engineering Datasheet, Document Number: 500-0659-00-09 Rev: 204



The World's Sixth Sense™

# FLIR LEPTON® Engineering Datasheet

Telemetry Mode	As header	As footer	Disabled
Packet 0	Telemetry line A	FPA Row 0	FPA Row 0
Packet 1	Telemetry line B	FPA Row 1	FPA Row 1
Packet 2	Telemetry line C	FPA Row 2	FPA Row 2
Packet 3	FPA Row 0	FPA Row 3	FPA Row 3
...	...	...	...
Packet 29	FPA Row 26	FPA Row 29	FPA Row 29
Packet 30	FPA Row 27	FPA Row 30	FPA Row 30
Packet 31	FPA Row 28	FPA Row 31	FPA Row 31
Packet 32	FPA Row 29	FPA Row 32	FPA Row 32
...	...	...	...
Packet 59	FPA Row 56	FPA Row 59	FPA Row 59
Packet 60	FPA Row 57	Telemetry line A	n/a
Packet 61	FPA Row 58	Telemetry line B	n/a
Packet 62	FPA Row 59	Telemetry line C	n/a

### 4.2.2.3 VoSPI Stream

A VoSPI stream is simply a continuous sequence of VoSPI frames following a synchronization event. Provided that synchronization is maintained, a VoSPI stream can continue indefinitely. Note that the frame rate of the stream of packets is nominally just below 27 Hz, allowing easy interface to a display system without the need for host-side frame buffering. However, the rate of unique frames is just below 9 Hz to comply with US export restrictions. For each unique 80x60 frame, two duplicates follow in the VoSPI stream. This pattern is illustrated in [Figure 25](#), with unique frames shown in blue and duplicates shown in gray. In some applications, it might be beneficial to identify the first of the three identical frames (the frame with the least latency). The 32-bit frame counter provided in the telemetry lines (see [Telemetry Modes](#), page 23) can be used for this purpose. It only increments on new frames, which is also illustrated in [Figure 25](#).

For 160x120 stream details, see Section 4.2.3 below, and also 110-0144-50 Lepton 3.x VoSPI Developers Guide.

The information contained herein does not contain technology as defined by the EAR, 15 CFR 772, is publicly available, and therefore, not subject to EAR. NSR (6/14/2018).

Information on this page is subject to change without notice.

Lepton Engineering Datasheet, Document Number: 500-0659-00-09 Rev: 204



The World's Sixth Sense™

# FLIR LEPTON® Engineering Datasheet

---

Figure 25 - Frame Counter for Successive 80x60 Frames

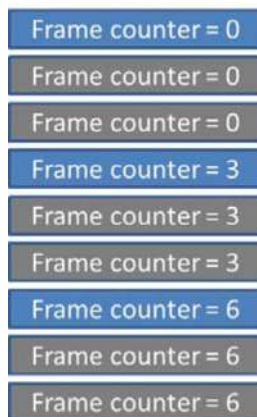

**NOTE:** Blue frames are different than the previous frames, gray frames are identical to the previous blue frame.

---

The information contained herein does not contain technology as defined by the EAR, 15 CFR 772, is publicly available, and therefore, not subject to EAR. NSR (6/14/2018).

Information on this page is subject to change without notice.

Lepton Engineering Datasheet, Document Number: 500-0659-00-09 Rev: 204



The World's Sixth Sense™

# FLIR LEPTON® Engineering Datasheet

## 4.2.2.3.1 Establishing/Re-Establishing Sync

The basic process for establishing synchronization is listed below:

- Deassert /CS and idle SCK for at least 5 frame periods (>185 msec). This step ensures a timeout of the VoSPI interface, which puts the Lepton in the proper state to establish (or re-establish) synchronization.
- Assert /CS and enable SCLK. This action causes the Lepton to start transmission of a first packet.
- Examine the ID field of the packet, identifying a discard packet. Read out the entire packet.
- Continue reading packets. When a new frame is available (should be less than 39 msec after asserting /CS and reading the first packet), the first video packet will be transmitted. The master and slave are now synchronized.

## 4.2.2.3.2 Maintaining Sync

There are three main violations that can result in a loss of synchronization:

- Intra-packet timeout. Once a packet starts, it must be completely clocked out within 3 line periods.
- Provided that VoSPI clock rate is appropriately selected and that /CS is not de-asserted (or SCLK disrupted) during the packet transfer, an intra-packet timeout is an unexpected event.
- Failing to read out all packets for a given frame before the next frame is available. Two examples of this violation are shown in [Figure 27](#) and [Figure 28](#). Note that the vertical blue line shown in the illustrations represents an internal frame-sync signal that indicates a new frame is ready for read-out.
- Failing to read out all available frames. This violation is depicted in [Figure 29](#). Note that the requirement to read out all frames applies to both the unique and the duplicate frames.

A CRC error does not result in an automatic loss of synchronization. However, as mentioned previously, it is recommended to intentionally re-synchronize (de-assert /CS for >185 msec) following a CRC error.

The following figures are examples of violations that result in a loss of synchronization.

**Figure 26 - Valid Frame Timing (no loss of synchronization)**

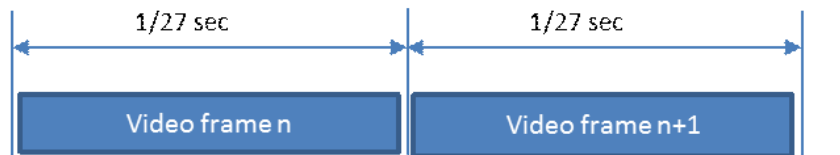

The information contained herein does not contain technology as defined by the EAR, 15 CFR 772, is publicly available, and therefore, not subject to EAR. NSR (6/14/2018).

Information on this page is subject to change without notice.

Lepton Engineering Datasheet, Document Number: 500-0659-00-09 Rev: 204



The World's Sixth Sense™

# FLIR LEPTON® Engineering Datasheet

Figure 27 - Clock Too Slow - Failure to Read an Entire Frame Within the Frame Period



Figure 28 - Intra-Frame Delay Too Long - Failure to Read Out an Entire Frame Before the Next is Available

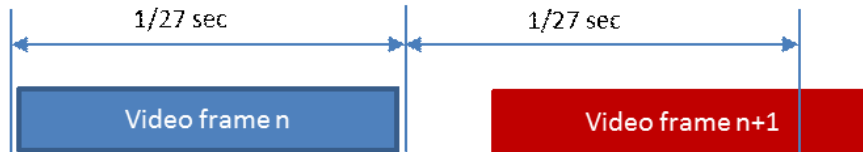
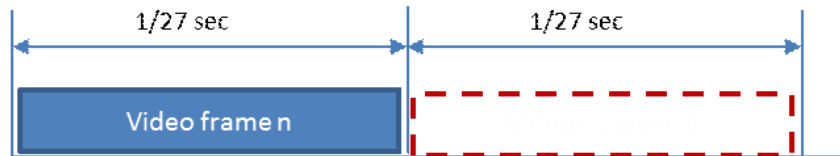

Figure 29 - Failure to Read Out an Available Frame



### 4.2.2.3.3 Frame Synchronization

The VoSPI protocol is designed such that embedded timing signals are not required. However, the Lepton does provide an optional frame-timing output pulse that can aid in optimizing host timing. For example, the host can burst-read data at a high clock rate and then idle until the next frame-timing pulse is received. The pulse is enabled by selecting the VSYNC GPIO mode via the CCI; when enabled, it is provided on the GPIO3 pin (see [GPIO Modes](#), page 39). The signal can be configured (also via the CCI) to lead or lag the actual internal start-of-frame (that is, the time at which the next frame is ready to be read) by -3 to +3 line periods (approximately -1.5 msec to +1.5 msec). By default, the pulse does not lead or lag.

The information contained herein does not contain technology as defined by the EAR, 15 CFR 772, is publicly available, and therefore, not subject to EAR. NSR (6/14/2018).

Information on this page is subject to change without notice.

Lepton Engineering Datasheet, Document Number: 500-0659-00-09 Rev: 204



The World's Sixth Sense™

# FLIR LEPTON® Engineering Datasheet

## 4.2.3 VoSPI Protocol – Lepton 3.0 and 3.5

The Lepton 3 VoSPI is built on a collection of object types as defined hierarchically below.

- **VoSPI Packet:** The Lepton 3 VoSPI protocol is based on a single standardized VoSPI packet, the minimum “transaction” between master and slave. Each video packet contains data for a single video line or telemetry line. In addition to video packets, the VoSPI protocol includes discard packets that are provided when no video packets are available.
- **VoSPI Segment:** A VoSPI segment is defined as a continuous sequence of VoSPI packets consisting of one quarter of a frame of pixel data. To maintain synchronization, it is necessary to read out each VoSPI segment before the next is available.
- **VoSPI Stream:** A VoSPI stream is defined as a continuous sequence of VoSPI segments.

As summarized in [Table 10](#), the packet length and number of packets per frame vary depending upon two runtime user selections, telemetry mode and bit resolution.

- **Telemetry mode:**
  - Telemetry disabled (default)
  - Telemetry enabled
- **Video Format mode:**
  - Raw14 (default)
  - RGB888

**Table 12 - Packet Length and Number of Video Packets per Frame as a Function of User Settings**

Video Format Mode	Telemetry Mode	
	Telemetry Disabled	Telemetry Enabled
Raw14	Packet length: 164 bytes Video packets per frame: 60	Packet length: 164 bytes Video packets per segment:
RGB888	Packet length: 244 bytes Video packets per frame: 60	N/A

### 4.2.3.1 VoSPI Packets

As depicted in [Figure 20](#), each packet contains a 4-byte header followed by either a 160-byte or 240-byte payload. Note that because the payload size differs between video formats, the setting should be selected *before*

The information contained herein does not contain technology as defined by the EAR, 15 CFR 772, is publicly available, and therefore, not subject to EAR. NSR (6/14/2018).

Information on this page is subject to change without notice.

Lepton Engineering Datasheet, Document Number: 500-0659-00-09 Rev: 204



The World's Sixth Sense™

# FLIR LEPTON® Engineering Datasheet

VoSPI synchronization is established. If the setting is changed while VoSPI is active, it is necessary to re-synchronize (see [VoSPI Stream, page 50](#)).

**Figure 30 - Generic VoSPI Packet**

ID	CRC	Payload
4 bytes		160 or 240 bytes (depending upon bit resolution setting)

For video packets, the header includes a 2-byte ID and a 2-byte CRC. The ID field encodes the segment number (1, 2, 3, or 4) and the packet number required to determine where the packet belongs in relation to the final 160 x 120 image (or 160x122 if telemetry is enabled). The segment and packet location in each frame is exemplified in [Figure 31](#). Recall that with telemetry disabled, each segment is comprised of 60 packets, each containing pixel data for half of a video line. With telemetry enabled, each segment is comprised of 61 packets.

**Figure 31 - Segment and Packet Relationship to the 160x120 video image**

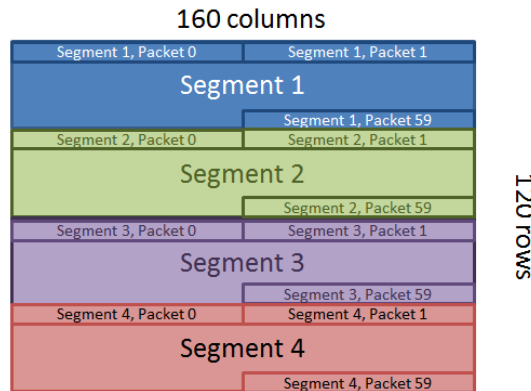

(a) Frame contents with telemetry disabled

The information contained herein does not contain technology as defined by the EAR, 15 CFR 772, is publicly available, and therefore, not subject to EAR. NSR (6/14/2018).

Information on this page is subject to change without notice.

Lepton Engineering Datasheet, Document Number: 500-0659-00-09 Rev: 204



The World's Sixth Sense™

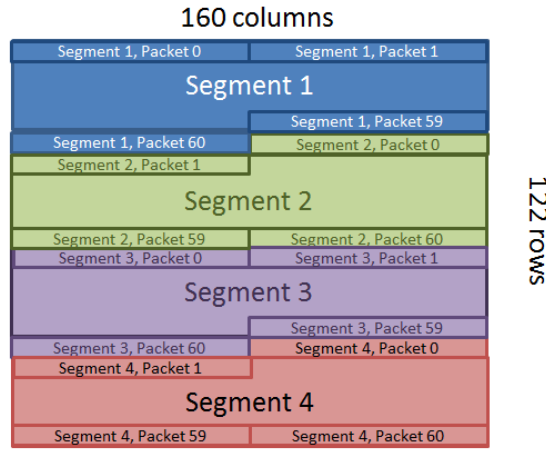

(b) Frame contents with telemetry enabled

As shown in [Figure 32](#), the first bit of the ID field is always a zero. The next three bits are referred to as the TTT bits, and the following 12 are the packet number. Note that packet numbers restart at 0 on each new segment. For all but packet number 20, the TTT bits can be ignored. On packet 20, the TTT bits encode the segment number (1, 2, 3, or 4). The encoded segment number can also have a value of zero. In this case the entire segment is invalid data and should be discarded. [Figure 32](#) also shows an example of Packet 20 of Segment 3.

**Figure 32 - Packet Header Encoding and an Example**

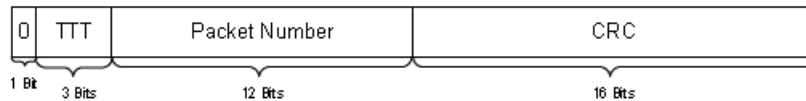

(a) Generic Encoding of the packet header

The information contained herein does not contain technology as defined by the EAR, 15 CFR 772, is publicly available, and therefore, not subject to EAR. NSR (6/14/2018).

Information on this page is subject to change without notice.

Lepton Engineering Datasheet, Document Number: 500-0659-00-09 Rev: 204



The World's Sixth Sense™



# FLIR LEPTON® Engineering Datasheet

0	0	1	1	0000 0001 0100	CRC
---	---	---	---	----------------	-----

(b) Example showing the packet header for line 20 of segment 3

The CRC portion of the packet header contains a 16-bit cyclic redundancy check (CRC), computed using the following polynomial:

$$x^{16} + x^{12} + x^5 + x^0$$

The CRC is calculated over the entire packet, including the ID and CRC fields. However, the four most-significant bits of the ID and all sixteen bits of the CRC are set to zero for calculation of the CRC. There is no requirement for the host to verify the CRC. However, if the host does find a CRC mismatch, it is recommended to re-synchronize the VoSPI stream to prevent potential misalignment.

At the beginning of SPI video transmission until synchronization is achieved (see [VoSPI Stream, page 50](#)), and in the idle period between frames, Lepton transmits discard packets until it has a new frame from its imaging pipeline. As shown in [Figure 22](#), the 2-byte ID field for discard packets is always xFxx (where 'x' signifies a “don't care” condition). Note that VoSPI-enabled cameras do not have vertical resolution approaching 3840 lines (0xF00), and therefore it is never possible for the ID field in a discard packet to be mistaken for a video line.

**Figure 33 - Discard Packet**

ID	CRC	Payload
xFxx	xxxx	Discard data (same number of bytes as video packets)

For video packets, the payload contents depend upon the selected bit resolution:

- For Raw14 mode (the default case), the payload is 160 bytes long. Excluding telemetry lines1, each packet contains pixel data for all 80 pixels in a single video line (with AGC disabled, the first two bits of each pixel's two-byte word are always set to 0; if AGC is enabled, the first eight bits are set to 0).
- For RGB888 mode, the payload is 240 bytes long. Excluding telemetry lines (which are invalid in RGB mode), each packet consists of pixel data for a single video line (3 bytes per pixel).

Each case is illustrated in the following payload encoding figures.

The information contained herein does not contain technology as defined by the EAR, 15 CFR 772, is publicly available, and therefore, not subject to EAR. NSR (6/14/2018).

Information on this page is subject to change without notice.

Lepton Engineering Datasheet, Document Number: 500-0659-00-09 Rev: 204



The World's Sixth Sense™

# FLIR LEPTON® Engineering Datasheet

**Figure 34 - Raw14 Mode: 1 video line per 160-byte payload**

Byte 0	Byte 1	Byte 2	Byte 3	...	Byte 158	Byte 159
Line m		Line m		...	Line m	
Pixel 0		Pixel 1			Pixel 79	

**Figure 35 - RGB888 Mode: 1 video line per 240-byte payload**

Byte 0	Byte 1	Byte 2	Byte 3	Byte 4	Byte 5	...	Byte 237	Byte 238	Byte 239
Line m	Line m	Line m	Line m	Line m	Line m		Line m	Line m	Line m
Pixel 0	Pixel 0	Pixel 0	Pixel 1	Pixel 1	Pixel 1		Pixel 79	Pixel 79	Pixel 79
R	G	B	R	G	B		R	G	B

**Note(s)**

1. See [Telemetry Modes, page 23](#) for payload contents of the telemetry lines

### 4.2.3.2 VoSPI Segments

Each valid Lepton 3 segment contains data for one quarter of a complete frame. With telemetry disabled, each segment includes 60 packets comprising 30 video rows. When telemetry is enabled, each segment includes 61 packets comprising 30.5 rows. Note that with telemetry enabled, two rows (4 packets) of pixel data is replaced by the telemetry lines; pixel data is either shifted down in which the bottom two rows are excluded (header mode) or up in which the top two rows are excluded (footer mode). With telemetry enabled as a header, packets 0-3 of segment 1 provide the telemetry data and the remaining 57 packets of segment 1 provide data for the first 28.5 rows of pixel data. Segments 2, 3, and 4 each provide data for 30.5 rows of pixel data. When telemetry is enabled as a footer, segments 1, 2, and 3 each provide data for 30.5 rows of pixel data whereas packets 0 – 56 of segment 4 contain 28.5 rows of pixel data, and packets 57 – 60 provide the telemetry data. The location of the telemetry lines is illustrated in [Figure 36](#).

**Figure 36 - Location of Telemetry Lines**

The information contained herein does not contain technology as defined by the EAR, 15 CFR 772, is publicly available, and therefore, not subject to EAR. NSR (6/14/2018).

Information on this page is subject to change without notice.

Lepton Engineering Datasheet, Document Number: 500-0659-00-09 Rev: 204



The World's Sixth Sense™

# FLIR LEPTON® Engineering Datasheet

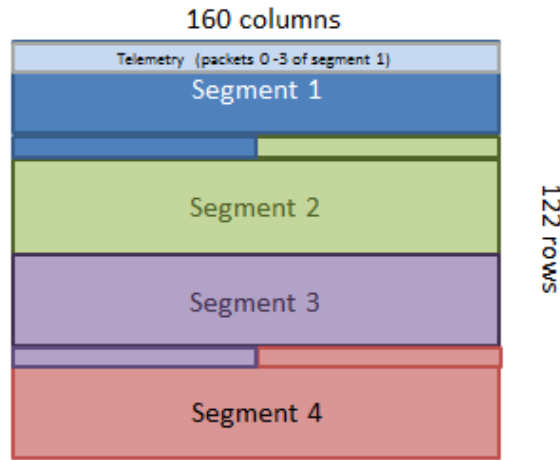

(a) Telemetry as header

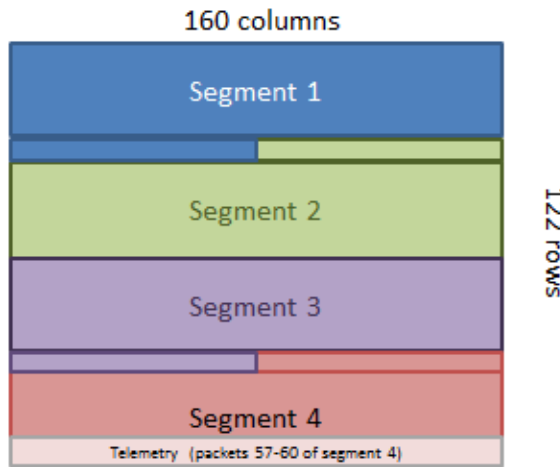

(b) Telemetry as footer

### 4.2.3.3 VoSPI Stream

A VoSPI stream is simply a continuous sequence of VoSPI segments following a synchronization event. Provided that synchronization is maintained, a VoSPI stream can continue indefinitely. The segment rate is approximately 106 Hz, which equates to a frame rate of ~ 26.5 Hz. However, the rate of *unique* and *valid* frames is just below 9 Hz to comply

The information contained herein does not contain technology as defined by the EAR, 15 CFR 772, is publicly available, and therefore, not subject to EAR. NSR (6/14/2018).

Information on this page is subject to change without notice.

Lepton Engineering Datasheet, Document Number: 500-0659-00-09 Rev: 204



The World's Sixth Sense™

# FLIR LEPTON® Engineering Datasheet

---

with US export restrictions. For each unique frame, two partial and invalid frames follow in the VoSPI stream. This pattern is illustrated in [Figure 37](#), with unique frames shown in blue and invalid frames shown in gray. The 32-bit frame counter provided in the telemetry lines (see [Telemetry Modes, page 23](#)) only increments on new frames, which is also illustrated in [Figure 37](#). The segment numbers will follow accordingly: 1, 2, 3, 4, 0, 0, 0, 0, 0, 0, 0, 1, 2, 3, 4, etc., where unique frames are comprised of segment numbers 1, 2, 3, 4 and invalid frames are comprised of zeros for each segment number.

**Figure 37 - Frame Counter for Successive Frames**

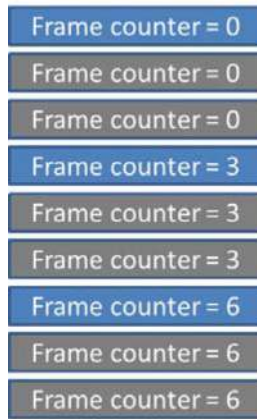

**NOTE:** Blue frames are different than the previous frames, gray frames are invalid.

---

### 4.2.3.3.1 Establishing/Re-Establishing Sync

The basic process for establishing synchronization is listed below:

- Deassert /CS and idle SCK for at least 5 frame periods (>185 msec). This step ensures a timeout of the VoSPI interface, which puts the Lepton 3 in the proper state to establish (or re-establish) synchronization.
- Assert /CS and enable SCLK. This action causes the Lepton 3 to start transmission of a first packet.
- Examine the ID field of the packet, identifying a discard packet. Read out the entire packet.

The information contained herein does not contain technology as defined by the EAR, 15 CFR 772, is publicly available, and therefore, not subject to EAR. NSR (6/14/2018).

Information on this page is subject to change without notice.

Lepton Engineering Datasheet, Document Number: 500-0659-00-09 Rev: 204



The World's Sixth Sense™

# FLIR LEPTON® Engineering Datasheet

- Continue reading packets. When a new segment is available (should be less than 10 msec after asserting /CS and reading the first packet), the first video packet will be transmitted. The master and slave are now synchronized.

### 4.2.3.3.2 Maintaining Sync

There are three main violations that can result in a loss of synchronization:

- Intra-packet timeout. Once a packet starts, it must be completely clocked out within 3 line periods.
- Provided that VoSPI clock rate is appropriately selected and that /CS is not de-asserted (or SCLK disrupted) in the midst of the packet transfer, an intra-packet timeout is an unexpected event.
- Failing to read out all packets for a given frame before the next frame is available. Two examples of this violation are shown in [Figure 27](#) and [Figure 28](#). Note that the vertical blue line shown in the illustrations represents an internal frame-sync signal that indicates a new frame is ready for read-out.
- Failing to read out all available frames. This violation is depicted in [Figure 29](#). Note that the requirement to read out all frames applies to both the unique and the duplicate frames.

A CRC error does not result in an automatic loss of synchronization. However, as mentioned previously, it is recommended to intentionally re-synchronize (de-assert /CS for >185 msec) following a CRC error.

The following figures are examples of violations that result in a loss of synchronization.

**Figure 38 - Valid Frame Timing (no loss of synchronization)**



**Figure 39 - Clock Too Slow - Failure to Read an Entire Frame Within the Frame Period**

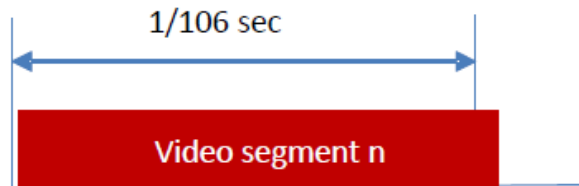

The information contained herein does not contain technology as defined by the EAR, 15 CFR 772, is publicly available, and therefore, not subject to EAR. NSR (6/14/2018).

Information on this page is subject to change without notice.

Lepton Engineering Datasheet, Document Number: 500-0659-00-09 Rev: 204



The World's Sixth Sense™

# FLIR LEPTON® Engineering Datasheet

Figure 40 - Intraframe Delay Too Long - Failure to Read Out an Entire Frame Before the Next is Available

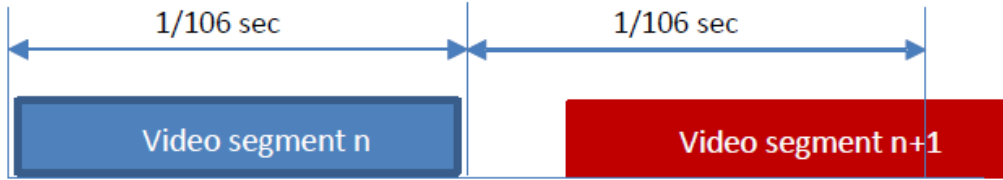
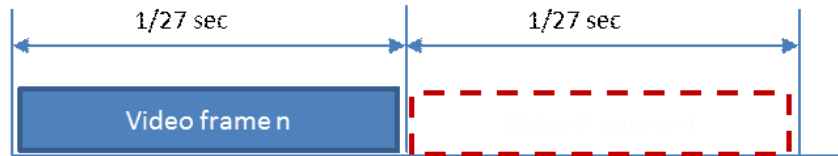

Figure 41 - Failure to Read Out an Available Frame



### 4.2.3.3.3 Frame Synchronization

The VoSPI protocol is designed such that embedded timing signals are not required. However, Lepton 3 does provide an optional frame-timing output pulse that can aid in optimizing host timing. For example, the host can burst-read data at a high clock rate and then idle until the next frame-timing pulse is received. The pulse is enabled by selecting the VSYNC GPIO mode via the CCI; when enabled, it is provided on the GPIO3 pin (see [GPIO Modes, page 39](#)). The signal can be configured (also via the CCI) to lead or lag the actual internal start-of-frame (that is, the time at which the next frame is ready to be read) by -3 to +3 line periods (approximately -1.5 msec to +1.5 msec). By default, the pulse does not lead or lag.

### 4.2.4 VoSPI Protocol – Lepton 2 vs. Lepton 3

This section is provided for customers already familiar with the Lepton VoSPI protocol. It concisely summarizes the difference between Lepton (80x60 resolution) and Lepton 3 (160x120 resolution). Much of the protocol is identical, including the following:

- 1) The physical layer is identical, including the SPI mode and timing.
- 2) The minimum VoSPI transaction is a packet, consisting of 164 bytes of data when in Raw14 video mode or 244 bytes of data when in RGB888 mode. The packet protocol, including the packet header and payload,

The information contained herein does not contain technology as defined by the EAR, 15 CFR 772, is publicly available, and therefore, not subject to EAR. NSR (6/14/2018).

Information on this page is subject to change without notice.

Lepton Engineering Datasheet, Document Number: 500-0659-00-09 Rev: 204



The World's Sixth Sense™

# FLIR LEPTON® Engineering Datasheet

---

are unchanged. However, it is worth noting a single packet represented a single 80-pixel video line for Lepton whereas it represents half of a 160-pixel video line in Lepton 3.

- 3) The synchronization requirements are identical with one exception. To maintain synchronization, Lepton requires each video frame to be read out prior to the next available frame. In contrast, Lepton 3 requires each *segment* to be read out prior to the next available segment, where a segment represents one-quarter of a video frame. Lepton 3 sync pulse cannot be used to synchronize external circuitry to frames.
- 4) For both Lepton and Lepton 3, each unique video frame is followed by two non-unique frames which must be read out to maintain synchronization. For Lepton each unique video frame is duplicated twice. For Lepton 3 each unique frame is followed by two partial, invalid frames.

The four most significant differences between the Lepton VoSPI interface and that for Lepton 3 are:

- 1) For Lepton, reconstructing a video frame from the individual packets requires the host to decode the packet number from each packet header. For Lepton 3, the host must decode both the packet number and the segment number.
- 2) There is 4X more data to be read per frame on Lepton 3 compared to Lepton. Therefore, the minimum SPI clock rate to read a frame of data is 4X higher.
- 3) If the sync pulse is enabled (see section 9.2.3), its frequency is 4X higher on Lepton 3 than on Lepton. For Lepton 3, the sync pulse represents when the next available segment is available whereas for Lepton it indicates when the next available frame is available.

When telemetry is enabled in Lepton, it results in three extra video lines (63 total packets per frame). When telemetry is enabled in Lepton 3, it results in 1 additional packet per segment for a total of 2 extra video lines.

## 5 Thermal Camera Basics

It is noteworthy that the integration period for a thermal detector does not have the same impact on image formation as it does for a photon detector, such as a typical CMOS array. While a photon detector converts incoming photons to electrons with near-instantaneous response a microbolometer, such as the Lepton, is always integrating incident radiation. That is to say, it is always “active” regardless of whether or not it is being actively integrated. The ability to detect high-speed phenomena is more a function of the detector's thermal time constant, which governs the rate of temperature change. For Lepton, the detector time constant is on the order of 12 msec, which means that an instantaneous irradiance change will result in a temperature change of the detector as shown in [Figure 42](#).

The information contained herein does not contain technology as defined by the EAR, 15 CFR 772, is publicly available, and therefore, not subject to EAR. NSR (6/14/2018).

Information on this page is subject to change without notice.

Lepton Engineering Datasheet, Document Number: 500-0659-00-09 Rev: 204



The World's Sixth Sense™

# FLIR LEPTON® Engineering Datasheet

Figure 42 - Illustration of Lepton Detector Time Constant

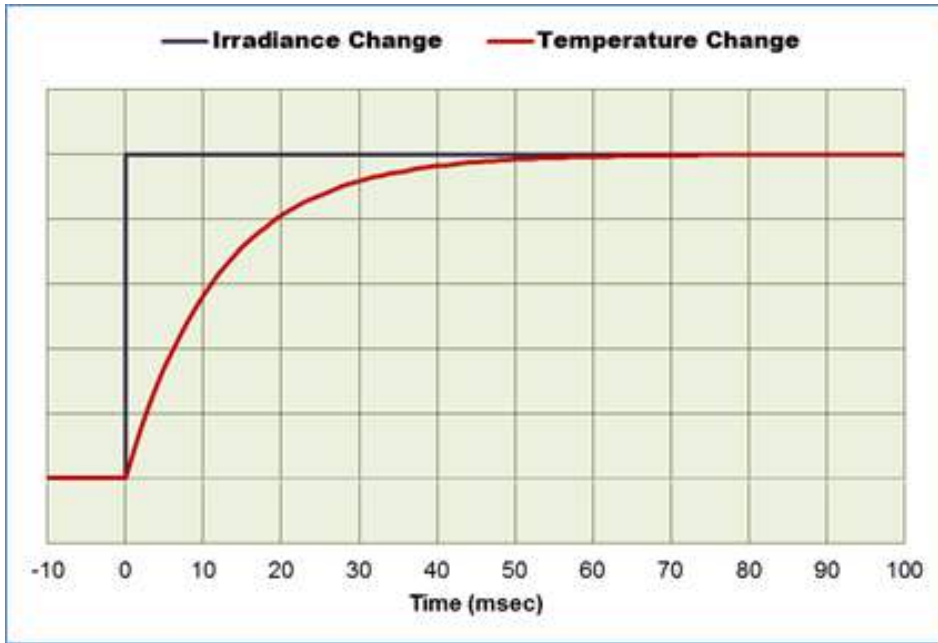

In addition to integrating signal current, the ROIC also digitizes and multiplexes the signal from each detector into a serial stream. And the Lepton ROIC digitizes data from an on-chip temperature sensor as well as a thermistor attached to the camera housing. An anti-reflection (AR) coated window is bonded above the sensor array via a wafer-level packaging (WLP) process, encapsulating the array in a vacuum. The purpose of the vacuum is to provide high thermal resistance between the microbolometer elements and the ROIC substrate, allowing for maximum temperature change in response to incident radiation.

The information contained herein does not contain technology as defined by the EAR, 15 CFR 772, is publicly available, and therefore, not subject to EAR. NSR (6/14/2018).

Information on this page is subject to change without notice.

Lepton Engineering Datasheet, Document Number: 500-0659-00-09 Rev: 204



The World's Sixth Sense™



# FLIR LEPTON® Engineering Datasheet

## 6 Mounting Specifications

The Lepton camera mechanical interface is defined in the drawings in section **References** on **page 6**. An example with socket is shown in **Figure 43**.

**Figure 43 - Lepton with Radiometry Camera Mounting Dimensions**

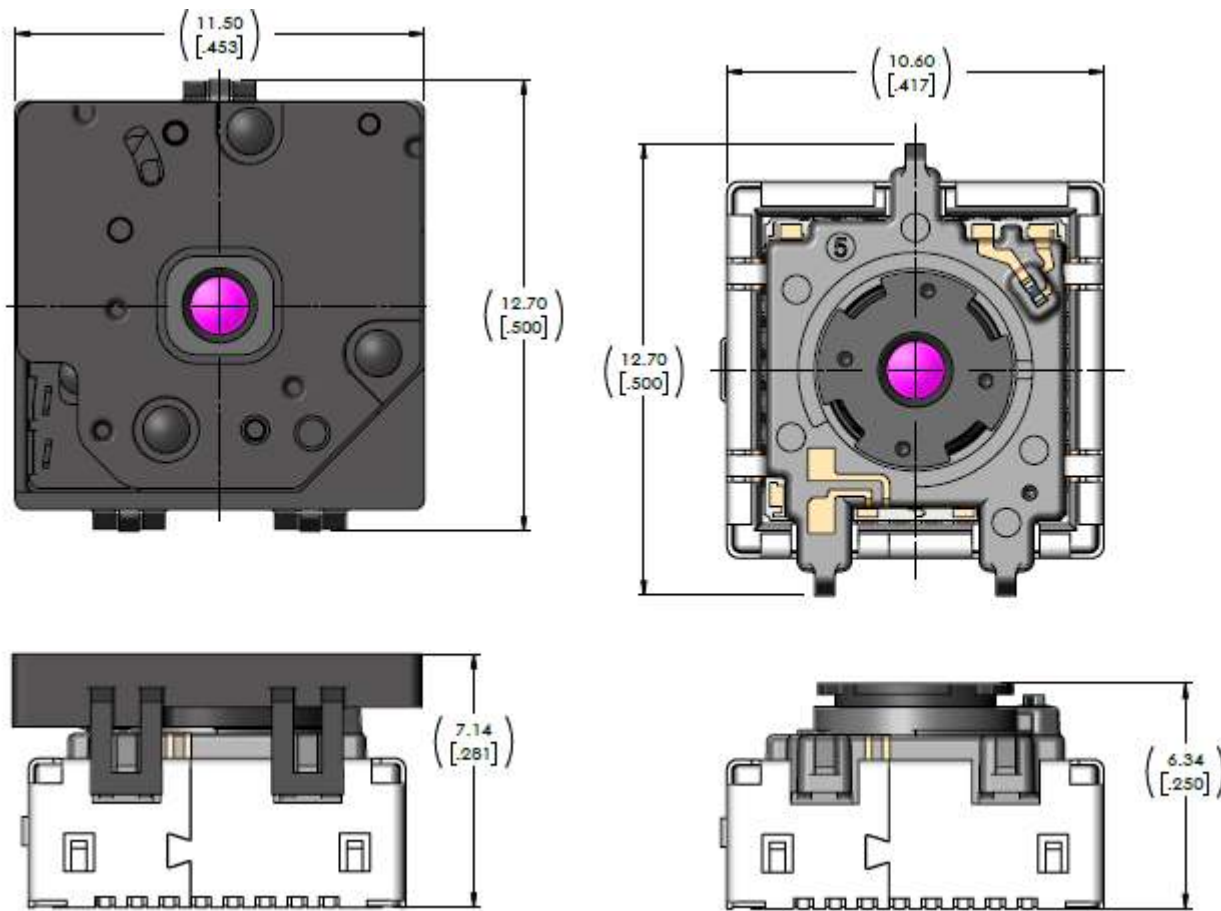

The information contained herein does not contain technology as defined by the EAR, 15 CFR 772, is publicly available, and therefore, not subject to EAR. NSR (6/14/2018).

Information on this page is subject to change without notice.

Lepton Engineering Datasheet, Document Number: 500-0659-00-09 Rev: 204



The World's Sixth Sense™

# FLIR LEPTON® Engineering Datasheet

---

## 6.1 Socket Information

The Lepton module is compatible with two commercially-available sockets, Molex 105028-1001 and Molex 105028-2031, illustrated in [Figure 44](#) below. The former makes electrical contact on the upper surface of a printed circuit board, the latter to the lower surface (with a cutout in the board that allows the socket to fit into). In both cases solder connections are made to the top or “component” side of the board. [Figure 45](#) depicts both socket configurations mounted on a PCB.

To order sockets, visit [www.arrow.com](http://www.arrow.com).

**Figure 44 - Two Commercially-available Sockets (both from Molex) Compatible with Lepton**

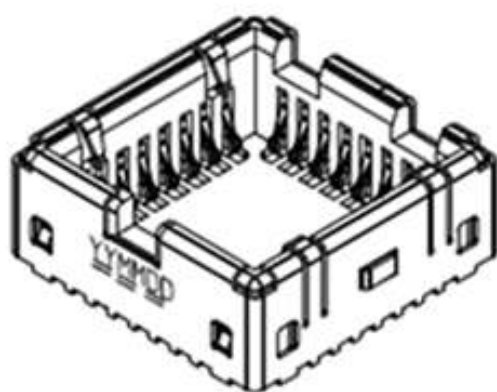

105028-1001

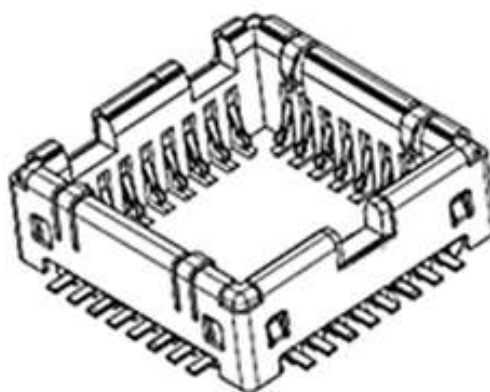

105028-2031

The information contained herein does not contain technology as defined by the EAR, 15 CFR 772, is publicly available, and therefore, not subject to EAR. NSR (6/14/2018).

Information on this page is subject to change without notice.

Lepton Engineering Datasheet, Document Number: 500-0659-00-09 Rev: 204



The World's Sixth Sense™

# FLIR LEPTON® Engineering Datasheet

Figure 45 - Both Sockets Mounted on a PCB

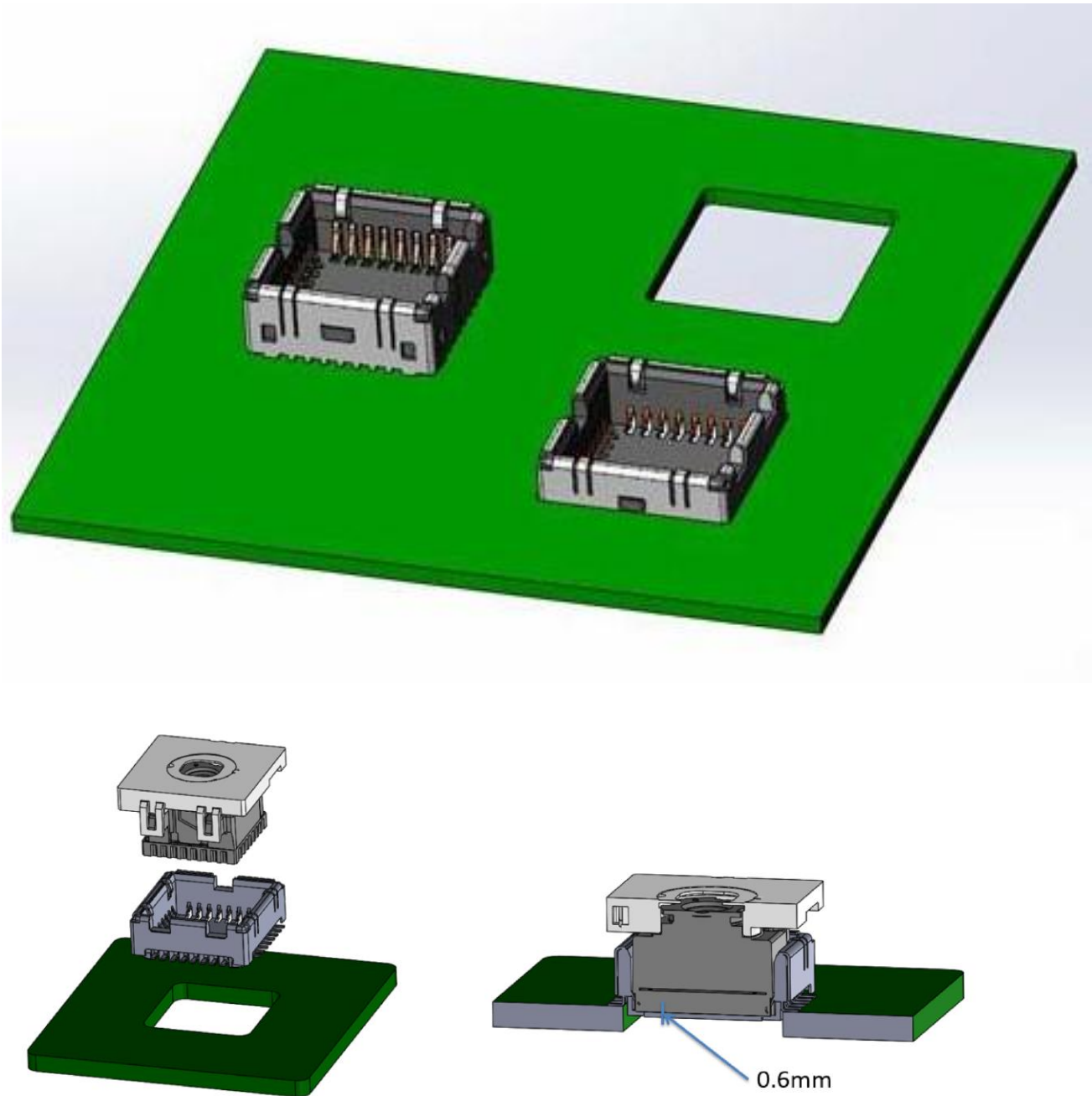

The information contained herein does not contain technology as defined by the EAR, 15 CFR 772, is publicly available, and therefore, not subject to EAR. NSR (6/14/2018).

Information on this page is subject to change without notice.

Lepton Engineering Datasheet, Document Number: 500-0659-00-09 Rev: 204



The World's Sixth Sense™

# FLIR LEPTON® Engineering Datasheet

## 6.2 Mechanical Considerations

The socket described in [Socket Information](#) on page 66 is not intended to retain the Lepton assembly under high-shock conditions. It is recommended to incorporate front-side retention such as illustrated in [Figure 46](#). Note that a maximum, uniform, load of 1kgF can be applied to the shutter face without causing failures in shutter actuation. When designing the foam thickness and compression the tolerances have to be such that the maximum force of 1kgF at the same time as enough force is exerted to keep the Lepton in the socket.

**Figure 46 - Recommended Approach to Retaining Lepton in the end Application**

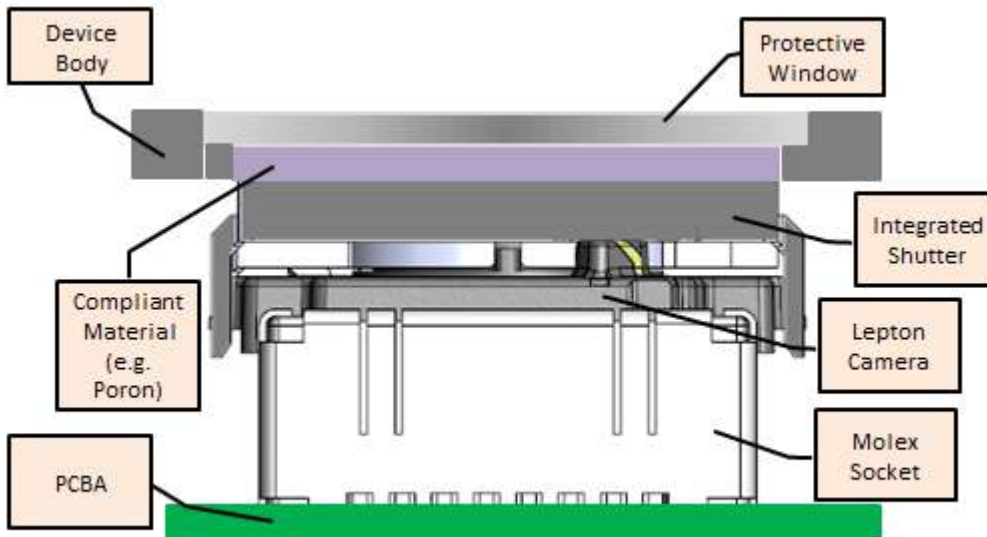

The Lepton camera is not a sealed assembly. Consequently, for most applications it is recommended to locate the assembly behind a sealed protective window. Common materials for LWIR windows include silicon, germanium, and zinc selenide (LWIR absorption in silicon is on the order of 15%/mm, which means NEDT is adversely affected using a silicon window. Bulk absorption in germanium and zinc selenide is negligible, and performance is essentially unchanged provided both surfaces of the window are anti-reflection (AR) coated.) Note that the window should be sized large enough to avoid encroaching upon the optical keep-out zone (see [Optical Considerations](#), page 69).

The information contained herein does not contain technology as defined by the EAR, 15 CFR 772, is publicly available, and therefore, not subject to EAR. NSR (6/14/2018).

Information on this page is subject to change without notice.

Lepton Engineering Datasheet, Document Number: 500-0659-00-09 Rev: 204



The World's Sixth Sense™

# FLIR LEPTON® Engineering Datasheet

## 6.3 Thermal Considerations

It is important to minimize any temperature gradient across the camera. The sensor should be mounted in such a fashion so as to isolate it from heat loads such as electronics, heaters, and non-symmetric external heating. The surrounding area must be able to support and withstand the dissipation of up to 160 mW of heat by the camera.

## 6.4 Optical Considerations

The optical keep-out zone is described by the three-dimensional field of view cone within the Lepton with Radiometry STEP file. To avoid mechanical vignetting, do not impinge upon the keep-out zone defined by this cone.

## 7 Image Characteristics

The information given in [Table 13](#) applies across the full operating temperature range.

**Table 13 - Image Characteristics**

Parameter	Description	Value
NETD	Noise Equivalent Temperature Difference (random temporal noise)	<50 mK, radiometry mode (35 mK typical)
Intra-scene Range	Minimum and maximum scene temperature	High Gain Mode: -10°C to 140°C, typical <sup>1</sup>
		Low Gain Mode: -10°C to 450°C, typical <sup>1</sup>
Operability	Number of non-defective pixels	>99.0%
Clusters	Number of adjacent defective pixels  “Adjacent” means any of the 8 nearest neighbors (or nearest 5 for an edge pixel, nearest 3 for a corner).	No clusters allowed.

### Note(s)

1. Scene dynamic range is a function of sensor characteristics and ambient temperature. Range values reported are typical values at room temperature ambient. See [Table 1- Key Specifications](#) for details.
2. Only single-pixel defects are allowed (no clusters).

The information contained herein does not contain technology as defined by the EAR, 15 CFR 772, is publicly available, and therefore, not subject to EAR. NSR (6/14/2018).

Information on this page is subject to change without notice.

Lepton Engineering Datasheet, Document Number: 500-0659-00-09 Rev: 204



The World's Sixth Sense™

# FLIR LEPTON® Engineering Datasheet

---

The nominal minimum on-axis modulation transfer function (MTF) at Nyquist/2 for the Lepton lens assembly is 63% for Lepton 1.5, 1.6, 2.0 and 2.5, and 51% for Lepton 3.0 and 3.5.

The information contained herein does not contain technology as defined by the EAR, 15 CFR 772, is publicly available, and therefore, not subject to EAR. NSR (6/14/2018).

Information on this page is subject to change without notice.

Lepton Engineering Datasheet, Document Number: 500-0659-00-09 Rev: 204



The World's Sixth Sense™

# FLIR LEPTON® Engineering Datasheet

## 8 Spectral Response

For reference, [Figure 47](#) depicts the typical spectral response of the Lepton camera.

Figure 47 - Normalized Response as a Function of Signal Wavelength for Lepton 1.5, 2.0 and 2.5

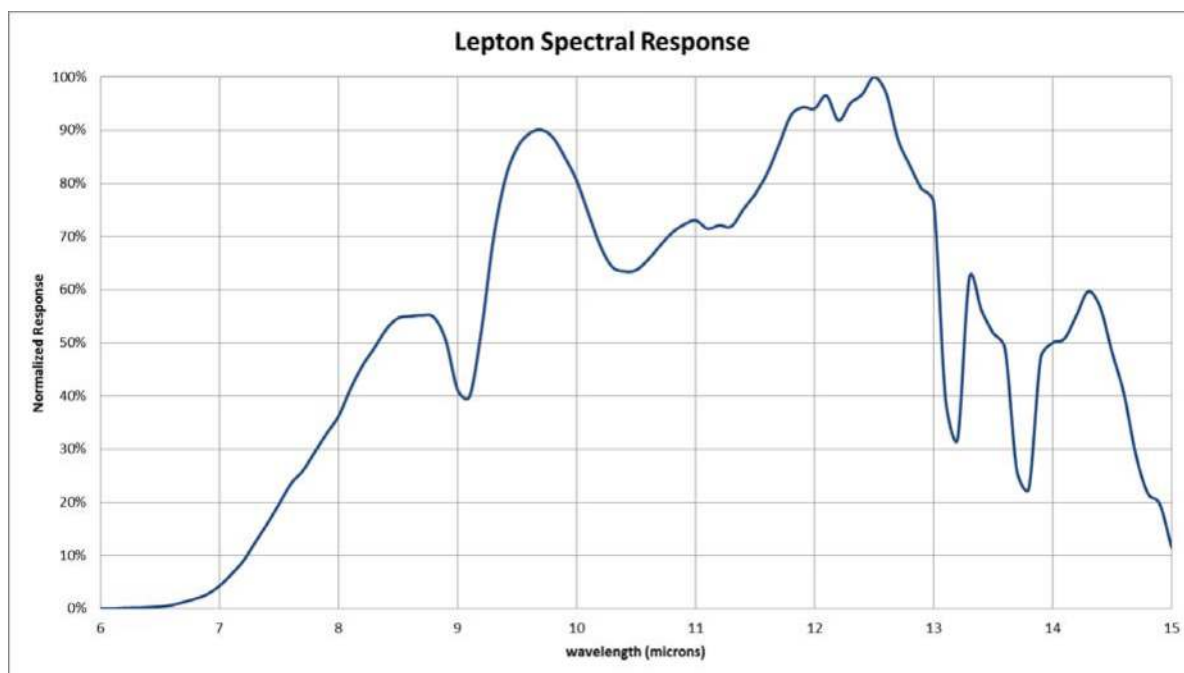

The information contained herein does not contain technology as defined by the EAR, 15 CFR 772, is publicly available, and therefore, not subject to EAR. NSR (6/14/2018).

Information on this page is subject to change without notice.

Lepton Engineering Datasheet, Document Number: 500-0659-00-09 Rev: 204



The World's Sixth Sense™

# FLIR LEPTON® Engineering Datasheet

Figure 48 - Normalized Response as a Function of Signal Wavelength for Lepton 3.0 and 3.5

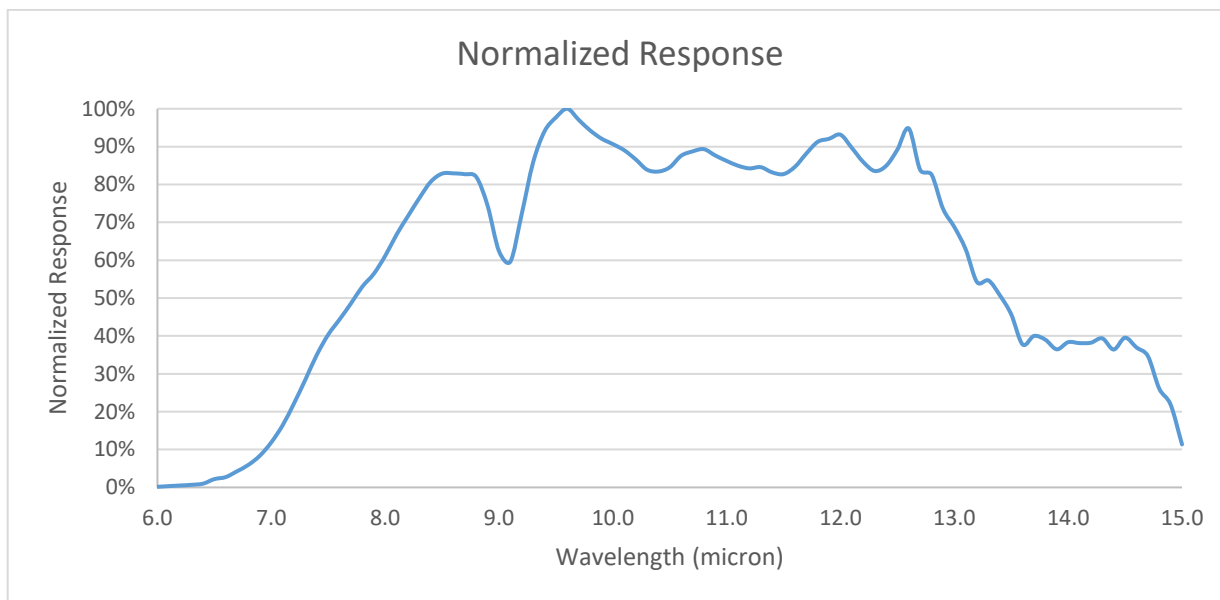

The information contained herein does not contain technology as defined by the EAR, 15 CFR 772, is publicly available, and therefore, not subject to EAR. NSR (6/14/2018).

Information on this page is subject to change without notice.

Lepton Engineering Datasheet, Document Number: 500-0659-00-09 Rev: 204



The World's Sixth Sense™



# FLIR LEPTON® Engineering Datasheet

## 9 Electrical Specifications

### 9.1 Lepton pin-out

Figure 49 - Pinout Diagram (viewed from bottom of camera module)

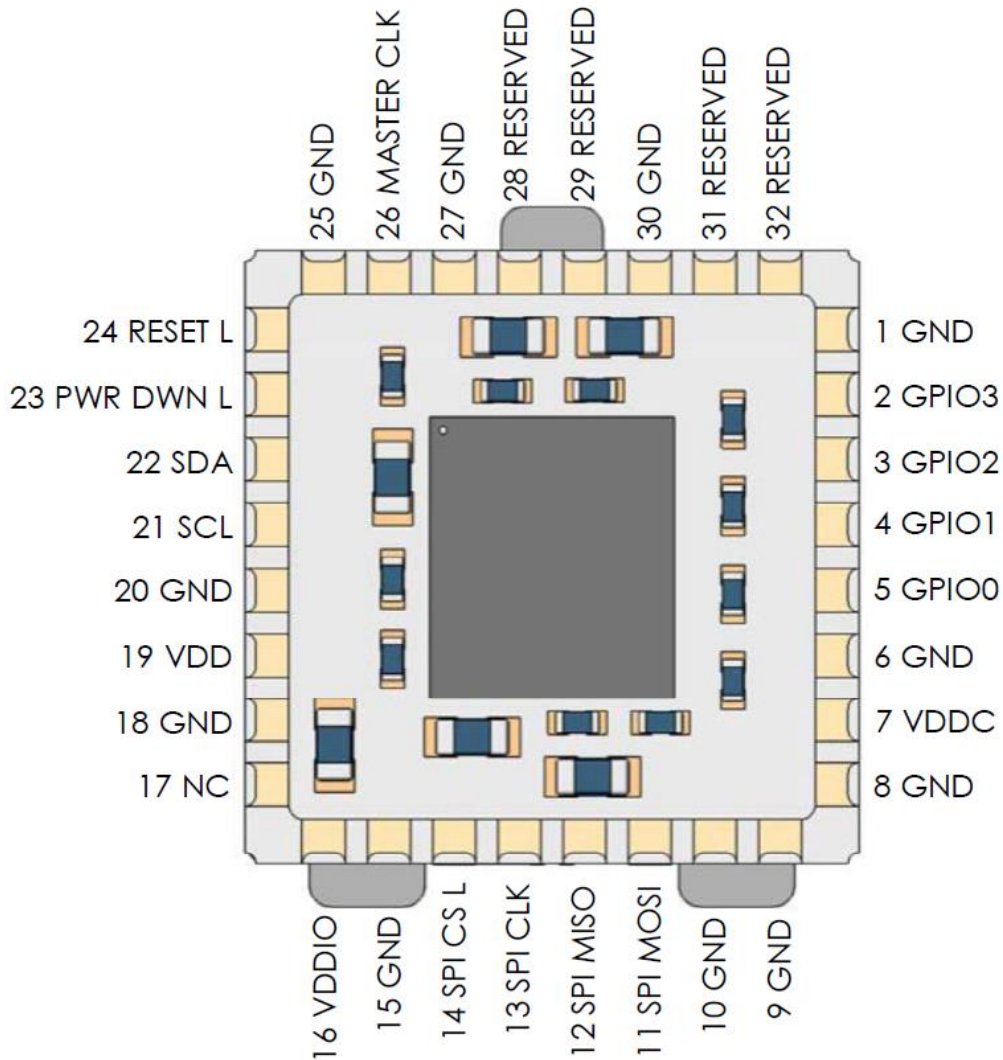

The information contained herein does not contain technology as defined by the EAR, 15 CFR 772, is publicly available, and therefore, not subject to EAR. NSR (6/14/2018).

Information on this page is subject to change without notice.

Lepton Engineering Datasheet, Document Number: 500-0659-00-09 Rev: 204



The World's Sixth Sense™

# FLIR LEPTON® Engineering Datasheet

Table 14 - Lepton Camera Module Pin Descriptions

Pin #	Pin Name	Signal Type	Signal Level	Description
1, 6, 8, 9, 10, 15, 18, 20, 25, 27, 30	GND	Power	GND	Common Ground
2	GPIO3/VSYNC	IN/OUT	VDDIO	Video output synchronization (see <a href="#">GPIO Modes</a> page 39)
3	GPIO2	IN/OUT	VDDIO	Reserved
4	GPIO1	IN/OUT	VDDIO	Reserved
5	GPIO0	IN/OUT	VDDIO	Reserved
7	VDDC	Power	1.2V	Supply for MIPI Core, PLL, ASIC Core (1.2V +/- 5%)
11	SPI_MOSI	IN	VDDIO	Video Over SPI Slave Data In (see <a href="#">VoSPI Channel</a> page 44)
12	SPI_MISO	OUT	VDDIO	Video Over SPI Slave Data Out (see <a href="#">VoSPI Channel</a> page 44)
13	SPI_CLK	IN	VDDIO	Video Over SPI Slave Clock (see <a href="#">VoSPI Channel</a> page 44)
14	SPI_CS_L	IN	VDDIO	Video Over SPI Slave Chip Select, active low (see <a href="#">VoSPI Channel</a> page 44)

The information contained herein does not contain technology as defined by the EAR, 15 CFR 772, is publicly available, and therefore, not subject to EAR. NSR (6/14/2018).

Information on this page is subject to change without notice.

Lepton Engineering Datasheet, Document Number: 500-0659-00-09 Rev: 204



The World's Sixth Sense™

# FLIR LEPTON® Engineering Datasheet

Table 15 - Lepton Camera Module Pin Descriptions (cont.)

Pin #	Pin Name	Signal Type	Signal Level	Description
16	VDDIO	Power	2.8 V — 3.1 V	Supply used for System IO
17	VPROG	—	—	See section 2.8.
19	VDD	Power	2.8V	Supply for Sensor (2.8V +/- 3%).
21	SCL	IN	VDDIO	Camera Control Interface Clock, I2C compatible (see <a href="#">Command and Control Interface</a> , page 40)
22	SDA	IN/OUT	VDDIO	Camera Control Interface Data, I2C compatible (see <a href="#">Command and Control Interface</a> , page 40)
23	PWR_DWN_L	IN	VDDIO	This active low signal shuts down the camera
24	RESET_L	IN	VDDIO	This active low signal resets the camera
26	MASTER_CLK	IN	VDDIO	ASIC Master Clock Input (see <a href="#">Master Clock</a> , page 15)
28	RESERVED			
29	RESERVED			
31	RESERVED			
32	RESERVED			

The information contained herein does not contain technology as defined by the EAR, 15 CFR 772, is publicly available, and therefore, not subject to EAR. NSR (6/14/2018).

Information on this page is subject to change without notice.

Lepton Engineering Datasheet, Document Number: 500-0659-00-09 Rev: 204



The World's Sixth Sense™

# FLIR LEPTON® Engineering Datasheet

## 9.2 DC and Logic Level Specifications

**Table 16 - DC and Logic Levels**

Symbol	Parameter	Min	Typ	Max	Units
VDDC	Core Voltage (primary power for the Lepton internal ASIC)	1.14	1.20	1.26	Volts
VDDC <sub>pp</sub>	VDDC, peak-to-peak ripple voltage	—	—	50	mV
VDD	Sensor Voltage (primary power for the Lepton internal sensor chip)	2.72	2.80	2.88	Volts
VDD <sub>pp</sub>	VDD, peak-to-peak ripple voltage	—	—	30	mV
VDDIO <sup>3</sup>	I/O Voltage (primary power for the Lepton I/O ring)	2.8	—	3.1	Volts
VDDIO <sub>pp</sub>	VDDIO, peak-to-peak ripple voltage	—	—	50	mV
I_DDC	Supply current for core (VDDC)	76	84	110	mA
I_DD	Supply current for sensor (VDD)	12	14	16 <sup>1</sup>	mA
I_DDIO	Supply current for I/O ring and shutter assembly (VDDIO)	1	235 mA (during FFC)	310mA <sup>2</sup> (during FFC)	mA

**Note(s)**

1. Maximum measured at 65 degrees C
2. Maximum at -10 degrees C
3. FLIR recommends utilizing two separate power supplies rather than a common supply for VDD and VDDIO due to noise considerations.

The information contained herein does not contain technology as defined by the EAR, 15 CFR 772, is publicly available, and therefore, not subject to EAR. NSR (6/14/2018).

Information on this page is subject to change without notice.

Lepton Engineering Datasheet, Document Number: 500-0659-00-09 Rev: 204



The World's Sixth Sense™

# FLIR LEPTON® Engineering Datasheet

## 9.3 AC Electrical Characteristics

**Table 17 - AC Electrical Characteristics**

Parameter	Min	Typ	Max	Units
MASTER_CLK, $F_{clk}$	24.975 MHz See note 1	25 MHz	25.025 MHz See note 1, 2	Master clock rate
MASTER_CLK, $F_{clk\ duty}$	45%	50%	55%	Master clock duty cycle
MASTER_CLK, $t_r$	--	--	3.4ns	Clock rise time (10% to 90%)
MASTER_CLK, $t_f$	--	--	3.4ns	Clock fall time (90% to 10%)
SPI_CLK, $F_{clk}$	See note 3		20 MHz	VoSPI clock rate
SPI_CLK, $F_{clk\ duty}$	45%	50%	55%	SPI-clock duty cycle
SPI_CLK, $t_r$	--	--	TBD	SPI clock rise time (10% to 90%)
SPI_CLK, $t_f$	--	--	TBD	SPI clock fall time (90% to 10%)
SCL, $F_{clk}$			1 MHz	I2C clock rate
SCL, $F_{clk\ duty}$	45%	50%	55%	I2C-clock duty cycle
SCL_CLK, $t_r$	--	--	TBD	I2C clock rise time (10% to 90%)
SCL_CLK, $t_f$	--	--	TBD	I2C clock fall time (90% to 10%)

**Note(s)**

1. Master clock frequencies significantly more or less than 25MHz may cause image degradation.
2. Master clock frequencies significantly above 25.5MHz will cause the camera to stop displaying live sensor data and display an overclock test pattern.
3. As described in [VoSPI Protocol](#), page 46, the minimum VoSPI clock frequency is dependent upon the requirement to read out all video packets for a given frame within the frame period. The size and number of video packets vary with user settings.

The information contained herein does not contain technology as defined by the EAR, 15 CFR 772, is publicly available, and therefore, not subject to EAR. NSR (6/14/2018).

Information on this page is subject to change without notice.

Lepton Engineering Datasheet, Document Number: 500-0659-00-09 Rev: 204



The World's Sixth Sense™

# FLIR LEPTON® Engineering Datasheet

---

## 9.4 Absolute Maximum Ratings

Electrical stresses beyond those listed in **Table 18** may cause permanent damage to the device. These are stress rating only, and functional operation of the device at these or any other conditions beyond those indicated under the recommended operating conditions listed in **Table 19** is not implied. Exposure to absolute-maximum-rated conditions for extended periods of time may affect device reliability.

**Table 18 - Absolute Maximum Ratings**

Parameter	Absolute Maximum Rating
Core Voltage (VDDC)	1.5 V
Sensor Voltage (VDD)	4.8 V
I/O Voltage (VDDIO)	4.8 V
Voltage on any I/O pin	Lesser of (VDDIO + 0.6V) or 4.8V

## 9.5 Electronic integration considerations

A typical example of integrating a Lepton on a PCB is shown in **Figure 50**. Matching Cadence design files can be found in **References**, page **6**. The MOSI signal is not used and can be grounded.

**Figure 50. Example of Lepton schematic.**

The information contained herein does not contain technology as defined by the EAR, 15 CFR 772, is publicly available, and therefore, not subject to EAR. NSR (6/14/2018).

Information on this page is subject to change without notice.

Lepton Engineering Datasheet, Document Number: 500-0659-00-09 Rev: 204



The World's Sixth Sense™

# FLIR LEPTON® Engineering Datasheet

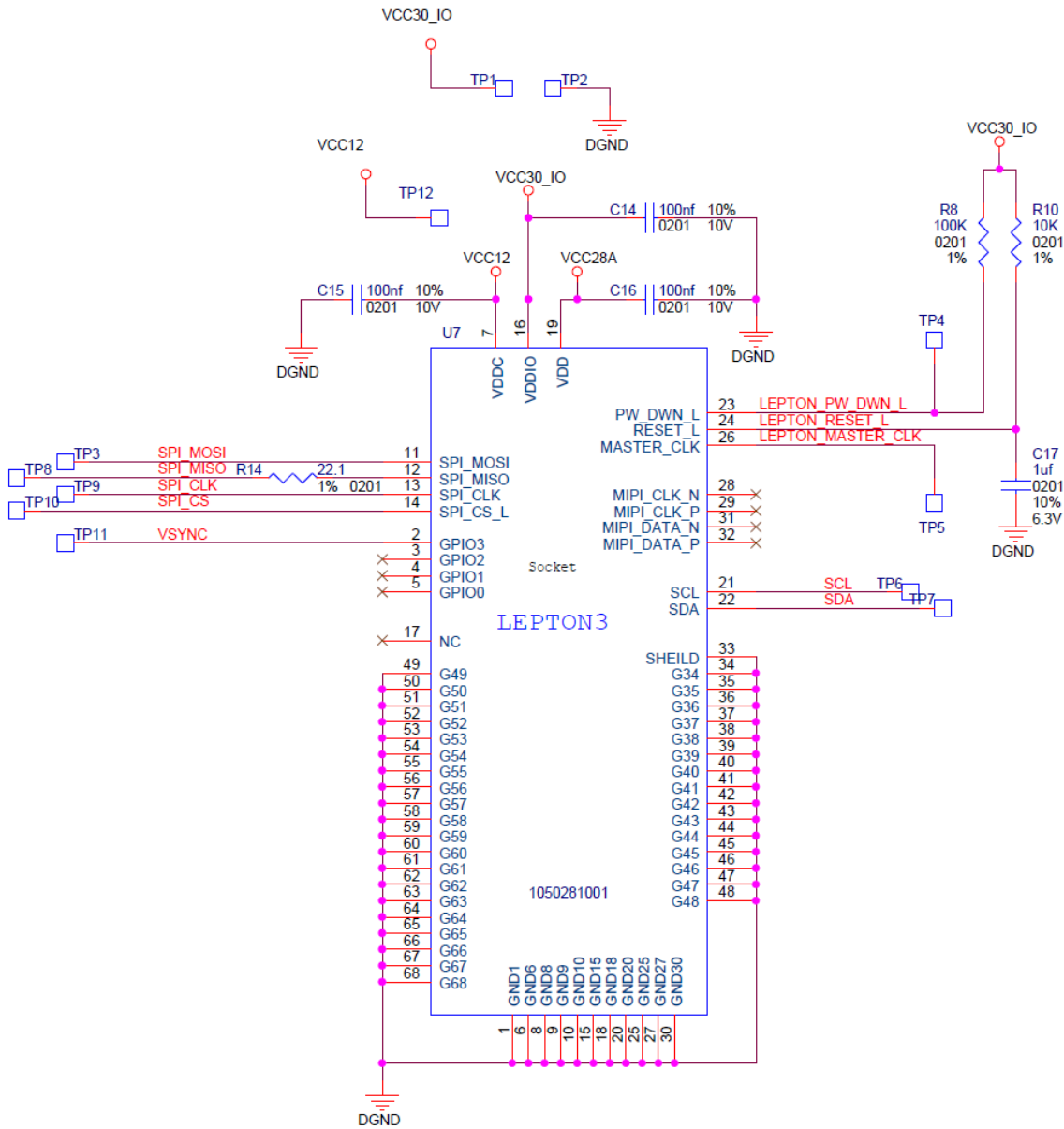

## 10 Environmental Specifications

The information contained herein does not contain technology as defined by the EAR, 15 CFR 772, is publicly available, and therefore, not subject to EAR. NSR (6/14/2018).

Information on this page is subject to change without notice.

Lepton Engineering Datasheet, Document Number: 500-0659-00-09 Rev: 204



The World's Sixth Sense™

# FLIR LEPTON® Engineering Datasheet

Environmental stresses beyond those listed may cause permanent damage to the device. Exposure to absolute-maximum-rated conditions for extended periods of time may affect device reliability.

**Table 19 - Environmental Specifications**

Stress	Maximum Rating
Operating Temperature Range	-10°C to 80°C (-20°C to 80°C with some possible performance degradation)
Maximum Operating Temperature	80 °C <sup>1</sup>
Shutter Operating Temperature	-10°C to 80°C <sup>2</sup>
Storage Temperature	-40°C to 80°C
Altitude (pressure)	12 km altitude equivalent
Relative Humidity	95%
Thermal Shock	Air-to-air across operating temp. extremes (-10°C to 65°C, 65°C to -10°C)
Mechanical Shock	1500 g, 0.4 msec
Vibration	Transportation profile, 4.3 grms
ESD	Human Body Model (HBM), 2kV Charged Device Model (CDM), 500V

Note(s)

1. Lepton contains an automatic shutdown feature when its internal temperature exceeds the maximum safe operating value. See [Power States](#), page 15.
2. Lepton contains an automatic shutter lockout feature that prevents the shutter from operating when its internal temperature is outside the range of -10°C to 80°C for Lepton 2.5 and 3.5, and -10°C to 65°C for Lepton 2.0 and 3.0. See [FFC States](#), page 18.

## 10.1 Compliance with Environmental Directives

Lepton complies with the following directives and regulations:

- Directive 2002/95/EC, “Restriction of the use of certain Hazardous Substances in electrical and electronic equipment (RoHS)”
- Directive 2002/96/ EC, “Waste Electrical and Electronic Equipment (WEEE)”.
- Regulation (EC) 1907/2006, “Registration, Evaluation, Authorization and Restriction of Chemicals (REACH)”

The information contained herein does not contain technology as defined by the EAR, 15 CFR 772, is publicly available, and therefore, not subject to EAR. NSR (6/14/2018).

Information on this page is subject to change without notice.

Lepton Engineering Datasheet, Document Number: 500-0659-00-09 Rev: 204



The World's Sixth Sense™



# FLIR LEPTON® Engineering Datasheet

---

The information contained herein does not contain technology as defined by the EAR, 15 CFR 772, is publicly available, and therefore, not subject to EAR. NSR (6/14/2018).

Information on this page is subject to change without notice.

Lepton Engineering Datasheet, Document Number: 500-0659-00-09 Rev: 204



The World's Sixth Sense™

# FLIR LEPTON® Engineering Datasheet

## 11 Abbreviations and Acronyms

Abbreviation	Description
AGC	Automatic Gain Control
AR	Anti-reflection
CCI	Command and Control Interface
CRC	Cyclic Redundancy Check
DSP	Digital Signal Processor
EMC	Electromagnetic Compatibility
FFC	Flat Field Correction
FOV	Field of View
FPA	Focal Plane Array
FPN	Fixed Pattern Noise
GPIO	General Purpose IO
HFOV	Horizontal Field of View
I2C	Inter-Integrated Circuit
IDD	Interface Description Document
LWIR	Long Wave Infrared
MISO	Maser In/Slave Out
MOSI	Master Out/Slave In
NEDT	Noise Equivalent Differential Temperature
NUC	Non-Uniformity Correction
OTP	One-Time Programmable
PLL	Phase-Lock Loop
REACH	Registration, Evaluation, Authorization, and Restriction of Chemicals

The information contained herein does not contain technology as defined by the EAR, 15 CFR 772, is publicly available, and therefore, not subject to EAR. NSR (6/14/2018).

Information on this page is subject to change without notice.

Lepton Engineering Datasheet, Document Number: 500-0659-00-09 Rev: 204



The World's Sixth Sense™

# FLIR LEPTON® Engineering Datasheet

---

RoHS	Reduction of Hazardous Substances
ROIC	Readout Integrated Circuit
SBNUC	Scene-based Non-uniformity Correction
SNR	Signal to Noise Ratio
SoC	System on a Chip
SPI	Serial Peripheral Interface
SVP	Software-based Video Processing
TCR	Temperature Coefficient of Resistance
TWI	Two-wire Interface
VoSPI	Video Over SPI
VOx	Vanadium-oxide
WEEE	Waste Electrical and Electronic Equipment
WLP	Wafer-level Packaging

The information contained herein does not contain technology as defined by the EAR, 15 CFR 772, is publicly available, and therefore, not subject to EAR. NSR (6/14/2018).

Information on this page is subject to change without notice.

Lepton Engineering Datasheet, Document Number: 500-0659-00-09 Rev: 204



The World's Sixth Sense™

# FLIR LEPTON® Engineering Datasheet

© FLIR Commercial Systems, 2014. All rights reserved worldwide. No parts of this manual, in whole or in part, may be copied, photocopied, translated, or transmitted to any electronic medium or machine readable form without the prior written permission of FLIR Commercial Systems

Names and marks appearing on the products herein are either registered trademarks or trademarks of FLIR Commercial Systems and/or its subsidiaries. All other trademarks, trade names or company names referenced herein are used for identification only and are the property of their respective owners.

This product is protected by patents, design patents, patents pending, or design patents pending.

If you have questions that are not covered in this manual, or need service, contact FLIR Commercial Systems Customer Support at 805.964.9797 for additional information prior to returning a camera.

This documentation and the requirements specified herein are subject to change without notice.



This equipment must be disposed of as electronic waste.

Contact your nearest FLIR Commercial Systems, Inc. representative for instructions on how to return the product to FLIR for proper disposal.

**FCC Notice.** This device is a subassembly designed for incorporation into other products in order to provide an infrared camera function. It is not an end-product fit for consumer use. When incorporated into a host device, the end-product will generate, use, and radiate radio frequency energy that may cause radio interference. As such, the end-product incorporating this subassembly must be tested and approved under the rules of the Federal Communications Commission (FCC) before the end-product may be offered for sale or lease, advertised, imported, sold, or leased in the United States. The FCC regulations are designed to provide reasonable protection against interference to radio communications. See 47 C.F.R. §§ 2.803 and 15.1 et seq.

**Industry Canada Notice.** This device is a subassembly designed for incorporation into other products in order to provide an infrared camera function. It is not an end-product fit for consumer use. When incorporated into a host device, the end-product will generate, use, and radiate radio frequency energy that may cause radio interference. As such, the end-product incorporating this subassembly must be tested for compliance with the Interference-Causing Equipment Standard, Digital Apparatus, ICES-003, of Industry Canada before the product incorporating this device may be manufactured or offered for sale or lease, imported, distributed, sold, or leased in Canada.

**Avis d'Industrie Canada.** Cet appareil est un sous-ensemble conçu pour être intégré à un autre produit afin de fournir une fonction de caméra infrarouge. Ce n'est pas un produit final destiné aux consommateurs. Une fois intégré à un dispositif hôte, le produit final va générer, utiliser et émettre de l'énergie radiofréquence qui pourrait provoquer de l'interférence radio. En tant que tel, le produit final intégrant ce sous-ensemble doit être testé pour en vérifier la conformité avec la Norme sur le matériel brouilleur pour les appareils numériques (NMB-003) d'Industrie Canada avant que le produit intégrant ce dispositif puisse être fabriqué, mis en vente ou en location, importé, distribué, vendu ou loué au Canada.

**EU Notice.** This device is a subassembly or component intended only for product evaluation, development or incorporation into other products in order to provide an infrared camera function. It is not a finished end-product fit for general consumer use. Persons handling this device must have appropriate electronics training and observe good engineering practice standards. As such, this product does not fall within the scope of the European Union (EU) directives regarding electromagnetic compatibility (EMC). Any end-product intended for general consumer use that incorporates this device must be tested in accordance and comply with all applicable EU EMC and other relevant directives.

The information contained herein does not contain technology as defined by the EAR, 15 CFR 772, is publicly available, and therefore, not subject to EAR. NSR (6/14/2018).

Information on this page is subject to change without notice.

Lepton Engineering Datasheet, Document Number: 500-0659-00-09 Rev: 204



The World's Sixth Sense™