

Pushbutton Switch (Microminiaturize) A9P

Two-point clip contact mechanism combined with see-saw action.

- Gold-plated clip contact and cleaning mechanisms ensure high reliability.
- Specially designed to allow no grease entry into the contact portion.
- Sealed against flux entry and a built-in "O-ring ensures immersion wash ability.
- Washable models. (IP64)
- RoHS

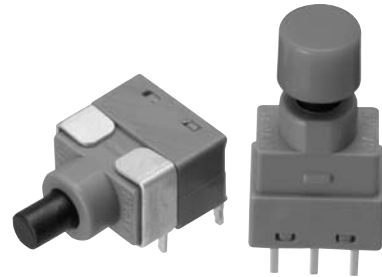

NEW

Ordering Information

● With button

Terminal style		DIP terminal		Right Angle		Vertical Mount	
Switching Function							
		Single Pole Double Throw	Double Pole Double Throw	Single Pole Double Throw	Double Pole Double Throw	Single Pole Double Throw	Double Pole Double Throw
ON	ON	A9P11-0031	A9P21-0031	A9P11-0032	A9P21-0032	A9P11-0033	A9P21-0033
ON	(ON)	A9P13-0031	A9P23-0031	A9P13-0032	A9P23-0032	A9P13-0033	A9P23-0033

Note: (ON) is Momentary

● Without button

Terminal style		DIP terminal		Right Angle		Vertical Mount	
Switching Function							
		Single Pole Double Throw	Double Pole Double Throw	Single Pole Double Throw	Double Pole Double Throw	Single Pole Double Throw	Double Pole Double Throw
ON	ON	A9P11-0011	A9P21-0011	A9P11-0012	A9P21-0012	A9P11-0013	A9P21-0013
ON	(ON)	A9P13-0011	A9P23-0011	A9P13-0012	A9P23-0012	A9P13-0013	A9P23-0013

Note: 1. (ON) is Momentary
 2. Plunger collar
 Gray: Alternate
 Ivory: Momentary

● Button

Available in a wide range of color.
 Please order separately excluding red.

Color	White	Black	Gray	Blue	Green	Yellow
	A9P-011	A9P-021	A9P-031	A9P-041	A9P-051	A9P-061
Configuration						

Specifications

Switching capacity		AC/DC 60V 50mA, AC/DC 20mV 1 μ A (minimum current)
Ambient temperature		-20 to 80 °C 60% RH Max. (with no icing or condensation)
Ambient humidity		operating : 45% to 85% (5 to 35 °C)
Insulation resistance		1000 MΩ min (Initial value)
Contact resistance		50 mΩ max (Initial value)
Dielectric strength		500VAC for 1 min between terminals, between terminals and ground
Vibration resistance	Malfunction	Malfunction: 10 to 55Hz, 1.5-mm double amplitude
Shock resistance	Malfunction	Malfunction: 500m/s ² min
Life expectancy	Mechanical	50,000 operations min
	Electrical	50,000 operations min
Operating force		Alternate: 1.96 to 6.86 N / Momentary: 1.47 to 3.43 N
Weight	DIP terminal	0.7 g
	Right Angle	0.9 g
	Vertical Mount	0.9 g

Dimensions

(Unit: mm)

● DIP terminal

With button

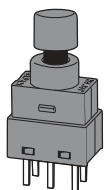
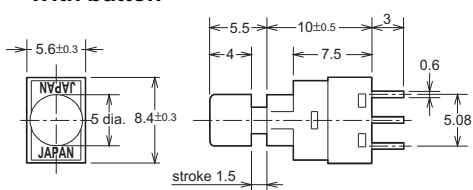

Without button

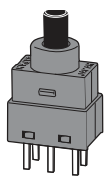
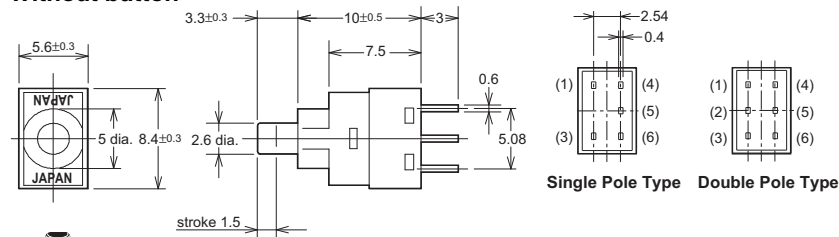

● Right Angle

With button

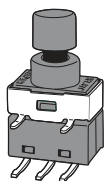
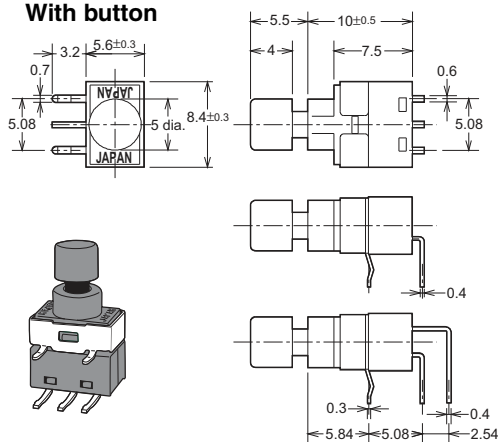

Without button

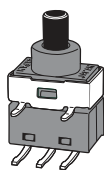
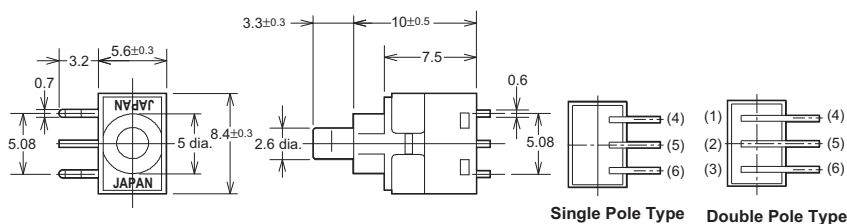

● Vertical Mount

With button

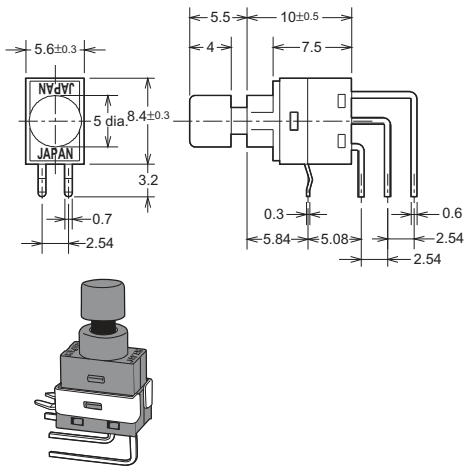

Without button

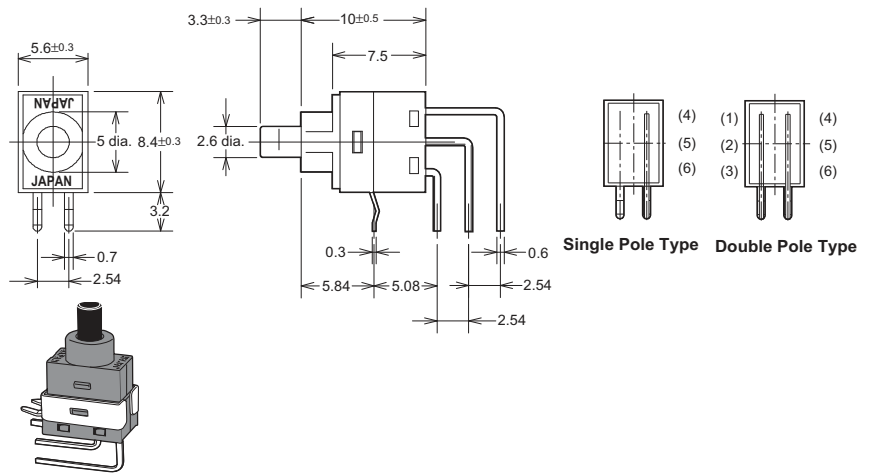

● PCB Dimensions (Top View)

DIP terminal

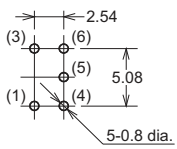

Single Pole Type

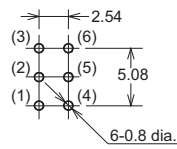

Double Pole Type

Right Angle

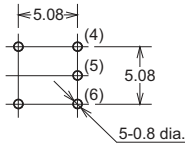

Single Pole Type

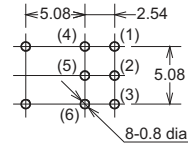

Double Pole Type

Vertical Mount

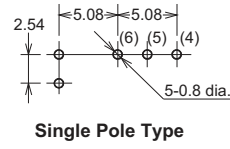

Single Pole Type

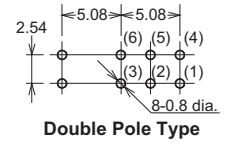

Double Pole Type

Switching Function / Internal Connections

	Switching Function		Internal Connections	
	ON	ON	ON	ON
Single Pole Type	ON	ON		
	ON	(ON)		
Double Pole Type	ON	ON		
	ON	(ON)		

Note: (ON) is Momentary

Safety Precautions

● Cautions

Use the Pushbutton Switch within the rated voltage and current ranges, otherwise the Pushbutton Switch may have a shortened life expectancy, radiate heat, or burn out. This particularly applies to the instantaneous voltages and currents when switching.

● Handling

Do not apply excessive operating force to the Switch. Otherwise the Switch may be damaged or deformed, and the switch mechanism may malfunction as a result. Apply an operating force not exceeding 9.8 N. Apply the operating load from the side of the striker. Do not apply a load from an angle or from above the striker. Doing so may deform the Switch contact.

● Soldering

Observe the following conditions when soldering the Pushbutton Switch.

Automatic Soldering Bath

Soldering temperature: 260°C max. (Preheating: 100°C 120 s)

Soldering time: 5 s max.

Manual Soldering

Soldering temperature: 350°C at the tip of the soldering iron.

Soldering time: 3 s max.

● Washing

Apply alcohol or fluorine based solvents to clean.

Do not clean the switch immediately after soldering. Wait for at least five minutes after soldering before cleaning.

Ultrasonic cleaning is not available dip into the switch washing agents for two minute maximum.

● Using Flux

Making mistakes in the type of flux or in the amount or method in which it is applied can cause flux to enter the interior of the Switch, with adverse effects on Switch performance. Assess the proper flux, conditions, and methods prior to using it.

● RoHS Compliant

The "RoHS Compliant" designation indicates that the listed models do not contain the six hazardous substances covered by the RoHS Directive.

Reference: The following standards are used to determine compliance for the six substances.

- Lead: 1,000 ppm max.
- Mercury: 1,000 ppm max.
- Cadmium: 100 ppm max.
- Hexavalent chromium: 1,000 ppm max.
- PBB: 1,000 ppm max.
- PBDE: 1,000 ppm max.

● Environment for Storage and Use

To prevent discoloration of the terminals and other problems during storage, do not store the switch in locations subject to the following conditions.

1. High temperatures or humidity
2. Corrosive gases
3. Direct sunlight

Also, the switch is not waterproof or splash-resistant. Do not install or use the switch in locations that are subject to contact with water. Do not subject the switch to freezing or condensation.

● Packing

100 per plastic bag.

ALL DIMENSIONS SHOWN ARE IN MILLIMETERS.

To convert millimeters into inches, multiply by 0.03937. To convert grams into ounces, multiply by 0.03527.

Cat. No. A170-E1-01 **In the interest of product improvement, specifications are subject to change without notice.**

OMRON Corporation

Electronic Components Company

Switch Division

Manual Switch Department

Shiokoji Horikawa, Shimogyo-ku,

Kyoto, 600-8530 Japan

Tel: (81)75-344-7096/Fax: (81)75-344-7188

Printed in Japan

0108 (0108)