



Features

- RoHS compliant*
- Leadless
- High speed



This series is currently available but not recommended for new designs.

Switching Chip Diode Series - 0603/1005

General Information

The markets of portable communications, computing and video equipment are challenging the semiconductor industry to develop increasingly smaller electronic components.

Bourns offers small-signal high-speed Switching Diodes for switching digital signal applications, in compact chip package 0603 and 1005 size format, which offer PCB real estate savings and are considerably smaller than competitive parts. The Switching Diodes offer a forward current of 100 mA or 150 mA, a reverse voltage of 80 V or 75 V and also have a low leakage reverse current option. The diodes are RoHS compliant with Cu/Ni/Au plated terminations and are compatible with lead-free manufacturing processes, conforming to many industry and government regulations on lead-free components.

Bourns® Chip Diodes conform to JEDEC standards, are easy to handle on standard pick and place equipment and their flat configuration minimizes roll away.

Electrical Characteristics (@ T_A = 25 °C Unless Otherwise Noted)

| Parameter | Symbol | CDxxxx-S0180 | CD1005-S01575 | CDxxxx-S0180R | Unit |
|--------------------------------------|-----------------|---|----------------------------------|-----------------------------------|------|
| Forward Voltage (Max.) | V _F | 1.00 (I _f = 100 mA) | 1.00 (I _f = 50 mA) | 1.00 (I _f = 100 mA) | V |
| Capacitance Between Terminals (Max.) | C _T | 4 (f = 100 MHz, V _r = 1 V DC) | | | pF |
| Reverse Recovery Time (Max.) | t _{rr} | 4 (V _r = 6 V, I _f = 10 mA, R _L = 50 ohms) | | | nS |
| Reverse Current (Max.) | I _R | 0.1 (V _r = 80 V) | 2.5 (V _r = 75 V) | 0.05 (V _r = 75 V) | μA |

Absolute Ratings (@ T_A = 25 °C Unless Otherwise Noted)

| Parameter | Symbol | CDxxxx-S0180 | CD1005-S01575 | CDxxxx-S0180R | Unit |
|---------------------------------------|--------------------|--------------|---------------|---------------|------|
| Repetitive Peak Reverse Voltage | V _{RRM} | 90 | 100 | 90 | V |
| Reverse Voltage | V _R | 80 | 75 | 80 | V |
| Average Forward Current | I _o | 100 | 150 | 100 | mA |
| Forward Current, Surge Peak | I _{surge} | 1** | 4*** | 1** | A |
| Power Dissipation CD0603 CD1005 | P _D | 150 300 | | | mW |
| Storage Temperature | T _{STG} | -40 to +125 | | | °C |
| Junction Temperature | T _J | -40 to +125 | | | °C |

** Condition: 8.3 ms single half sine-wave superimposed on rate load (JEDEC method).

*** Condition: 1.0 μs single half sine-wave superimposed on rate load (JEDEC method).

How to Order

| | |
|--|----------------------------|
| | CD 0603 - S 01 80 R |
| Common Code | _____ |
| Chip Diode | _____ |
| Package | _____ |
| • 0603 | |
| • 1005 | |
| Model | _____ |
| S = High-Speed Switching | |
| Average Forward Current (I _o) Code | _____ |
| 01 = 100 mA | |
| 015 = 150 mA | |
| (Code x 1000 mA = Average Forward Current) | |
| Reverse Voltage (V _R) Code | _____ |
| 80 = 80 V | |
| 75 = 75 V | |
| Reverse Current Suffix | _____ |
| R = Low Leakage I _R (CDxxxx-S0180R) | |

*RoHS Directive 2002/95/EC Jan. 27, 2003 including annex and RoHS Recast 2011/65/EU June 8, 2011.

Specifications are subject to change without notice.

The device characteristics and parameters in this data sheet can and do vary in different applications and actual device performance may vary over time.

Users should verify actual device performance in their specific applications.

Applications

- Cellular phones
- PDAs
- Desktop PCs and notebooks
- Digital cameras
- MP3 players

Switching Chip Diode Series - 0603/1005

BOURNS®

Product Dimensions

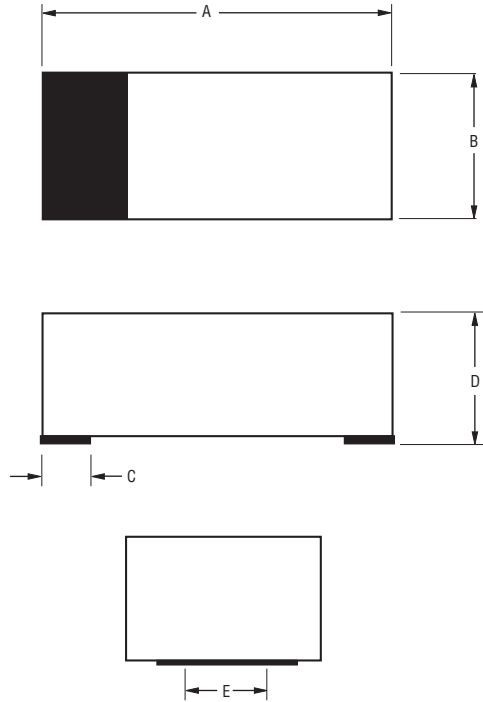

| Dimension | 0603 | 1005 |
|-----------|---------------------------------------|---------------------------------------|
| A | $\frac{1.60 - 1.80}{(0.063 - 0.071)}$ | $\frac{2.40 - 2.60}{(0.095 - 0.102)}$ |
| B | $\frac{0.80 - 1.00}{(0.031 - 0.039)}$ | $\frac{1.10 - 1.30}{(0.043 - 0.051)}$ |
| C | $\frac{0.45}{(0.018)}$ Typ. | $\frac{0.50}{(0.020)}$ Typ. |
| D | $\frac{0.70 - 0.85}{(0.027 - 0.033)}$ | $\frac{0.70 - 0.90}{(0.027 - 0.035)}$ |
| E | $\frac{0.70}{(0.028)}$ Typ. | $\frac{1.00}{(0.039)}$ Typ. |

DIMENSIONS: $\frac{\text{MM}}{(\text{INCHES})}$

Recommended Pad Layout

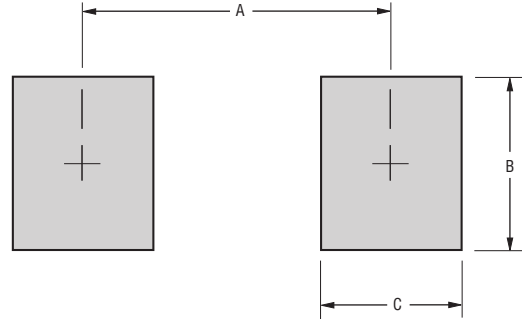

| Dimension | 0603 | 1005 |
|-----------|------------------------|------------------------|
| A (Max.) | $\frac{1.25}{(0.049)}$ | $\frac{2.00}{(0.079)}$ |
| B (Min.) | $\frac{1.00}{(0.039)}$ | $\frac{1.3}{(0.051)}$ |
| C (Min.) | $\frac{0.6}{(0.024)}$ | $\frac{0.7}{(0.028)}$ |

DIMENSIONS: $\frac{\text{MM}}{(\text{INCHES})}$

Physical Specifications

Case 0603(1608) / 1005(2512) Molded plastic
 Terminals Solder plated, solderable per MIL-STD-750,
 Method 2026
 Polarity..... Indicated by cathode band
 Mounting Position Any

Typical Part Marking

CDxxx-S0180..... S1
 CD1005-S01575..... S3
 CDxxx-S0180R..... S2

Switching Chip Diode Series - 0603/1005

BOURNS®

Rating & Characteristic Curves: CDxxxx-S0180

Forward Characteristics

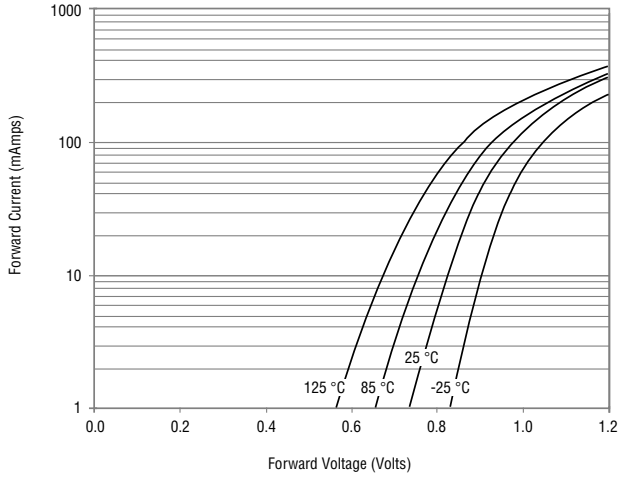

Reverse Characteristics

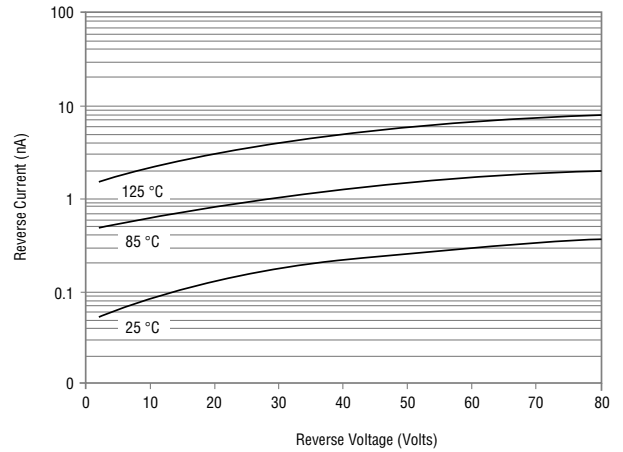

Derating Curve

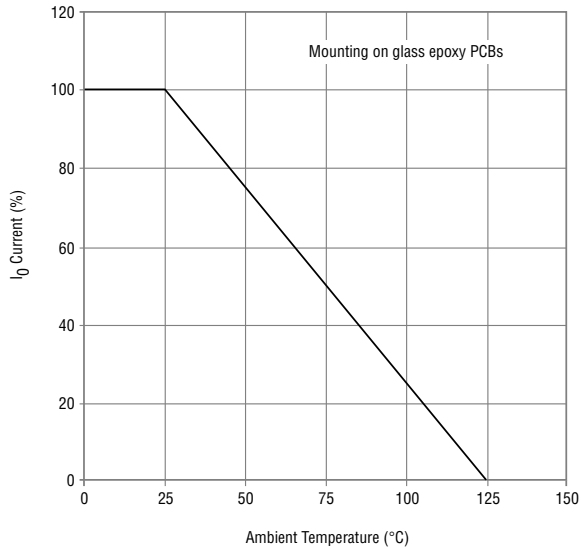

Capacitance Between Terminals

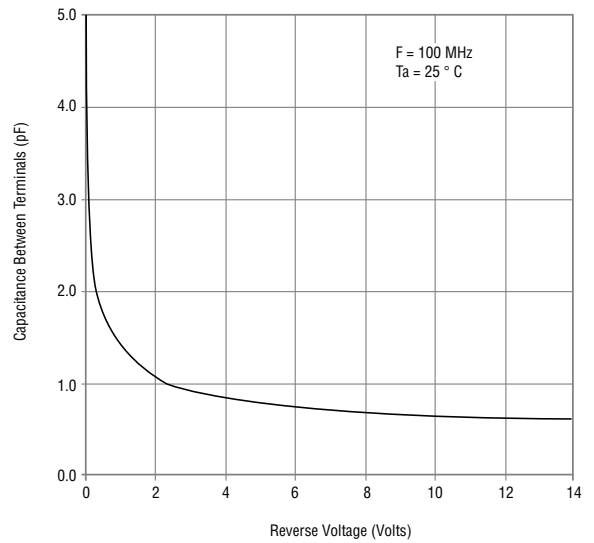

Specifications are subject to change without notice.
 The device characteristics and parameters in this data sheet can and do vary in different applications and actual device performance may vary over time.
 Users should verify actual device performance in their specific applications.

Switching Chip Diode Series - 0603/1005

BOURNS®

Rating & Characteristic Curves: CD1005-S01575

Forward Characteristics

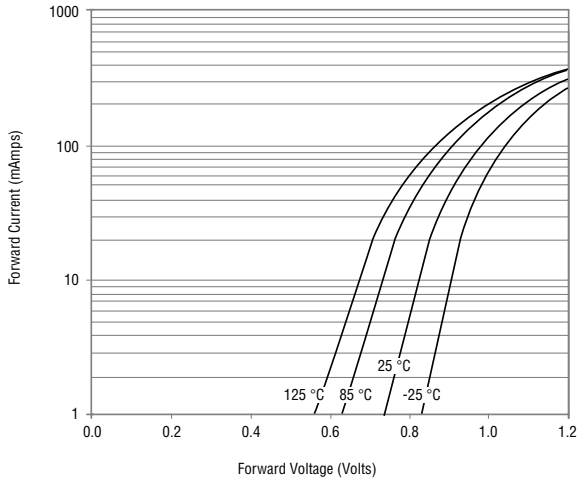

Reverse Characteristics

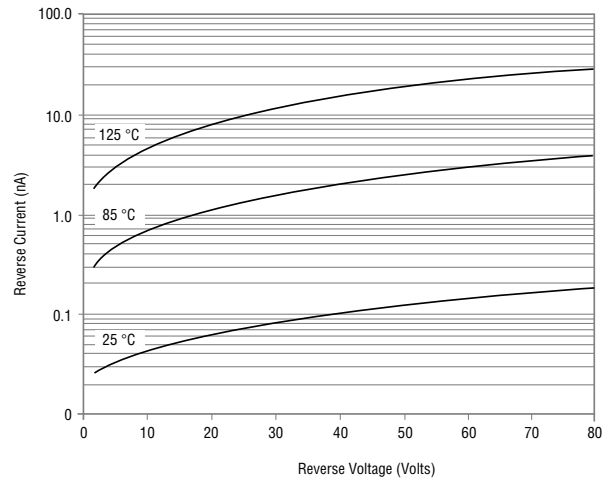

Derating Curve

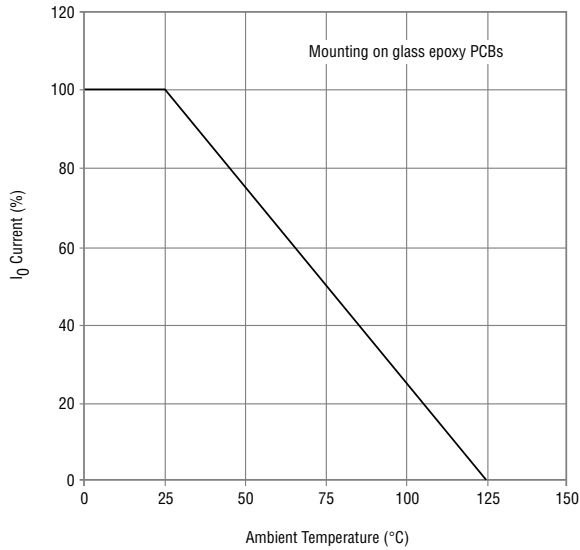

Capacitance Between Terminals

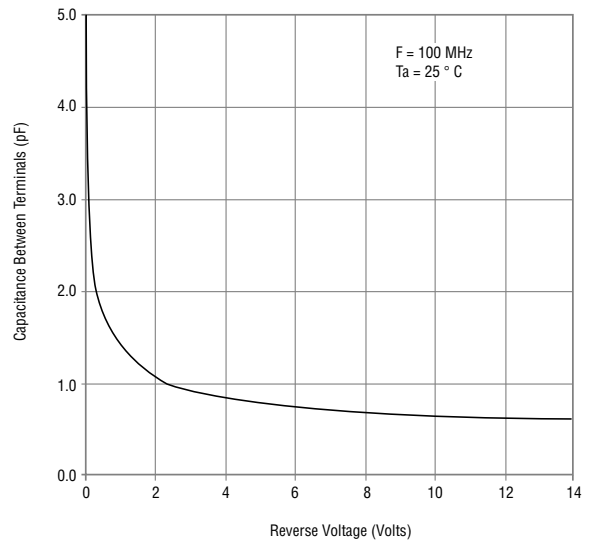

Specifications are subject to change without notice. The device characteristics and parameters in this data sheet can and do vary in different applications and actual device performance may vary over time. Users should verify actual device performance in their specific applications.

Switching Chip Diode Series - 0603/1005

BOURNS®

Rating & Characteristic Curves: CDxxxx-S0180R

Forward Characteristics

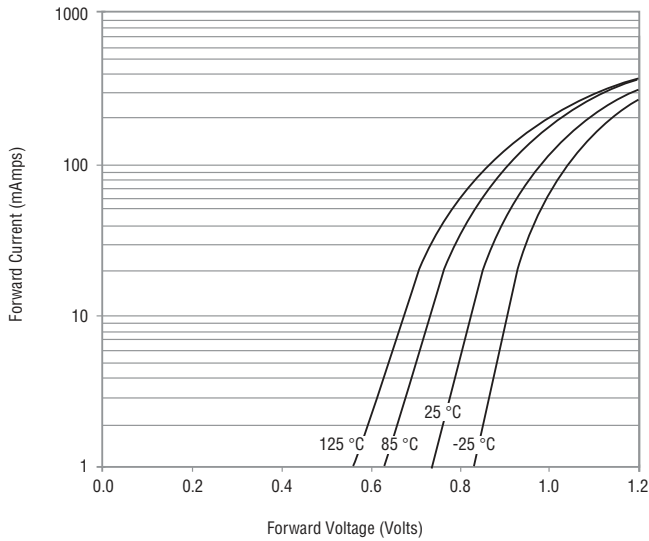

Reverse Characteristics

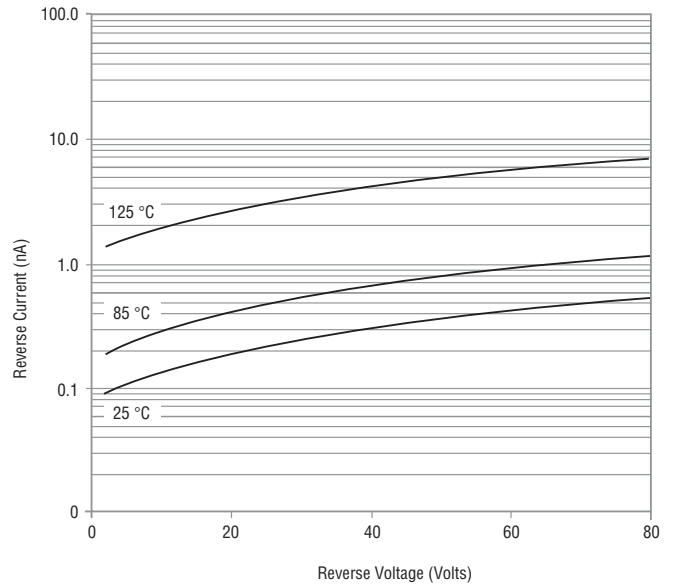

Derating Curve

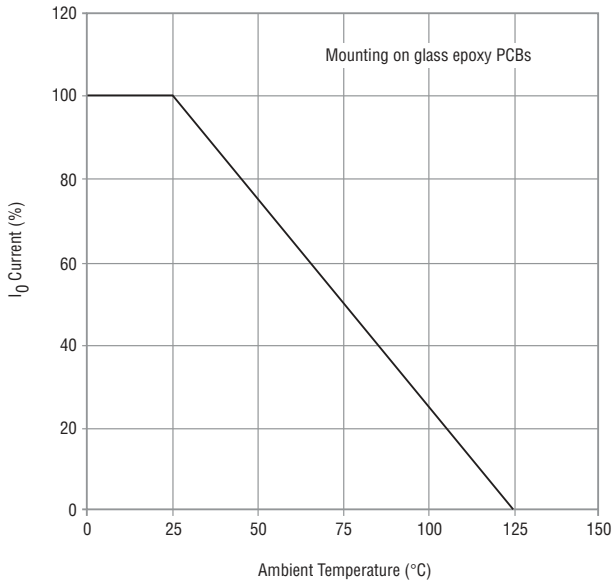

Capacitance Between Terminals

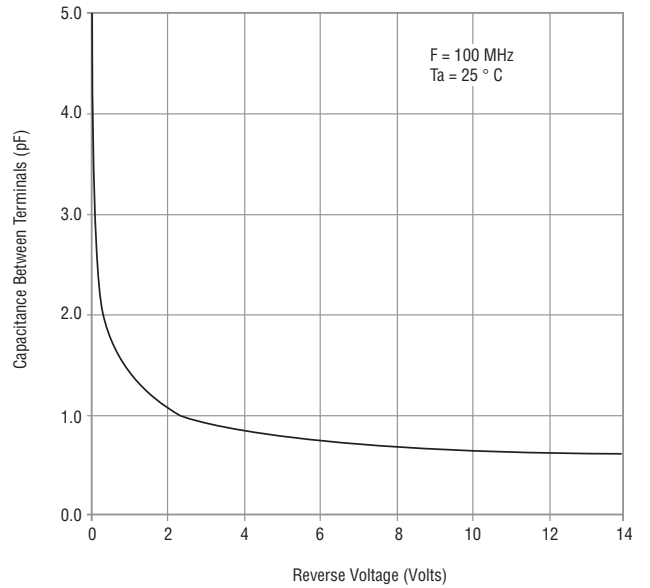

Specifications are subject to change without notice.
 The device characteristics and parameters in this data sheet can and do vary in different applications and actual device performance may vary over time.
 Users should verify actual device performance in their specific applications.

Switching Chip Diode Series - 0603/1005

BOURNS®

Packaging Information

The product is packaged in tape and reel format per EIA-481 standard.

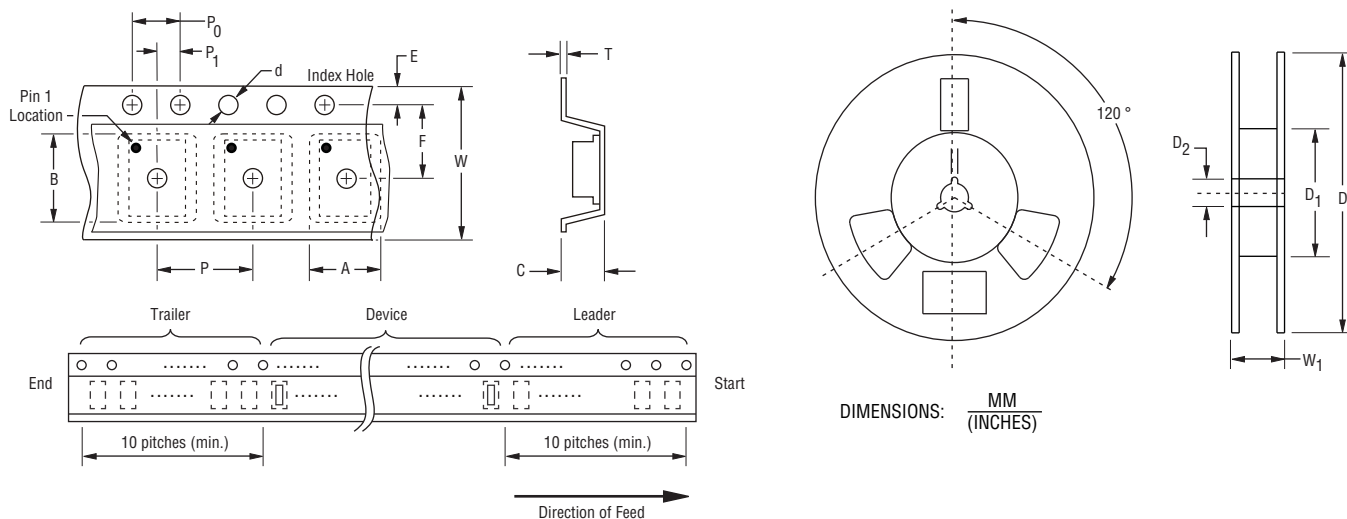

| Item | Symbol | 0603 | 1005 |
|------------------------|----------------|---|---|
| Carrier Width | A | $\frac{1.00 \pm 0.10}{(0.039 \pm 0.004)}$ | $\frac{1.55 \pm 0.10}{(0.061 \pm 0.004)}$ |
| Carrier Length | B | $\frac{1.85 \pm 0.10}{(0.073 \pm 0.004)}$ | $\frac{2.65 \pm 0.10}{(0.104 \pm 0.004)}$ |
| Carrier Depth | C | $\frac{1.00 \pm 0.10}{(0.039 \pm 0.004)}$ | $\frac{1.05 \pm 0.10}{(0.041 \pm 0.004)}$ |
| Sprocket Hole | d | $\frac{1.55 \pm 0.05}{(0.061 \pm 0.002)}$ | $\frac{1.55 \pm 0.10}{(0.061 \pm 0.004)}$ |
| Reel Outside Diameter | D | $\frac{178}{(7.008)}$ | $\frac{178}{(7.008)}$ |
| Reel Inner Diameter | D ₁ | $\frac{60.0}{(2.362)}$ MIN. | $\frac{60.0}{(2.362)}$ MIN. |
| Feed Hole Diameter | D ₂ | $\frac{13.0 \pm 0.20}{(0.512 \pm 0.008)}$ | $\frac{13.0 \pm 0.20}{(0.512 \pm 0.008)}$ |
| Sprocket Hole Position | E | $\frac{1.75 \pm 0.10}{(0.069 \pm 0.004)}$ | $\frac{1.75 \pm 0.10}{(0.069 \pm 0.004)}$ |
| Punch Hole Position | F | $\frac{3.50 \pm 0.05}{(0.138 \pm 0.002)}$ | $\frac{3.50 \pm 0.05}{(0.138 \pm 0.002)}$ |
| Punch Hole Pitch | P | $\frac{4.00 \pm 0.10}{(0.157 \pm 0.004)}$ | $\frac{4.00 \pm 0.10}{(0.157 \pm 0.004)}$ |
| Sprocket Hole Pitch | P ₀ | $\frac{4.00 \pm 0.10}{(0.157 \pm 0.004)}$ | $\frac{4.00 \pm 0.10}{(0.157 \pm 0.004)}$ |
| Embossment Center | P ₁ | $\frac{2.00 \pm 0.05}{(0.079 \pm 0.002)}$ | $\frac{2.00 \pm 0.05}{(0.079 \pm 0.002)}$ |
| Overall Tape Thickness | T | $\frac{0.20 \pm 0.05}{(0.008 \pm 0.002)}$ | $\frac{0.25 \pm 0.05}{(0.010 \pm 0.002)}$ |
| Tape Width | W | $\frac{8.00 \pm 0.20}{(0.315 \pm 0.008)}$ | $\frac{8.00 \pm 0.20}{(0.315 \pm 0.008)}$ |
| Reel Width | W ₁ | $\frac{13.5}{(0.531)}$ MAX. | $\frac{13.5}{(0.531)}$ MAX. |
| Quantity per Reel | -- | 4,000 | 4,000 |

REV. 12/15

Specifications are subject to change without notice.
 The device characteristics and parameters in this data sheet can and do vary in different applications and actual device performance may vary over time.
 Users should verify actual device performance in their specific applications.