

ISL8700A, ISL8701A, ISL8702A, ISL8703A, ISL8704A, ISL8705A

FN6381  
Rev 1.00  
July 24, 2014

The ISL8700A, ISL8701A, ISL8702A, ISL8703A, ISL8704A, ISL8705A family of ICs provide four delay adjustable sequenced outputs while monitoring an input voltage all with a minimum of external components.

High performance DSP, FPGA,  $\mu$ P and various subsystems require input power sequencing for proper functionality at initial power-up and the ISL870XA provides this function while monitoring the distributed voltage for over and undervoltage compliance.

These ICs operate over the +3.3V to +24V nominal voltage range. All have a user adjustable time from UV and OV voltage compliance to sequencing start via an external capacitor when in auto start mode and adjustable time delay to subsequent ENABLE output signal via external resistors.

Additionally, the ISL8702A, ISL8703A, ISL8704A and ISL8705A provide I/O for sequencing on and off operation (SEQ\_EN) and for voltage window compliance reporting (FAULT) over the +3.3V to +24V nominal voltage range.

Easily daisy chained for more than 4 sequenced signals.

Altogether, the ISL870XA provides these adjustable features with a minimum of external BOM. See Figure 1 for typical implementation.

Ordering Information

PART NUMBER (Note 1)	PART MARKING	TEMP. RANGE (°C)	PACKAGE (Pb-free)	PKG. DWG. #
ISL8700AIBZ*	ISL 8700AIBZ	-40 to +85	14 Ld SOIC	M14.15
ISL8701AIBZ*	ISL 8701AIBZ	-40 to +85	14 Ld SOIC	M14.15
ISL8702AIBZ*	ISL 8702AIBZ	-40 to +85	14 Ld SOIC	M14.15
ISL8703AIBZ*	ISL 8703AIBZ	-40 to +85	14 Ld SOIC	M14.15
ISL8704AIBZ*	ISL 8704AIBZ	-40 to +85	14 Ld SOIC	M14.15
ISL8705AIBZ*	ISL 8705AIBZ	-40 to +85	14 Ld SOIC	M14.15
ISL870XAEVAL1	Evaluation Platform			

\*Add "-T" suffix for tape and reel.

NOTES:

- Intersil Pb-free plus anneal products employ special Pb-free material sets; molding compounds/die attach materials and 100% matte tin plate termination finish, which are RoHS compliant and compatible with both SnPb and Pb-free soldering operations. Intersil Pb-free products are MSL classified at Pb-free peak reflow temperatures that meet or exceed the Pb-free requirements of IPC/JEDEC J STD-020.

Features

- Adjustable Delay to Subsequent Enable Signal
- Adjustable Delay to Sequence Auto Start
- Adjustable Distributed Voltage Monitoring
- Under and Overvoltage Adjustable Delay to Auto Start Sequence
- I/O Options  
ENABLE (ISL8700A, ISL8702A, ISL8704A) and ENABLE# (ISL8701A, ISL8703A, ISL8705A)  
SEQ\_EN (ISL8702A, ISL8703A) and SEQ\_EN# (ISL8704A, ISL8705A)
- Voltage Compliance Fault Output
- Pb-Free (RoHS Compliant)

Applications

- Power Supply Sequencing
- System Timing Function

Pinout

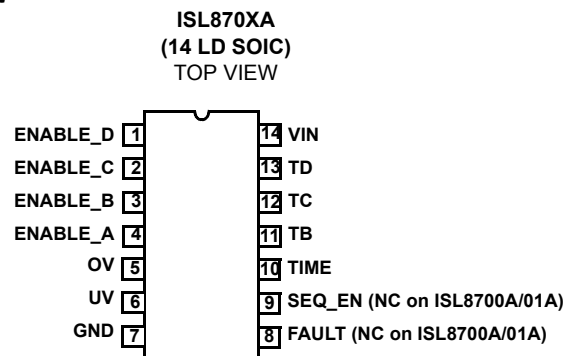

ISL8701A, ISL8703A, ISL8705A PINS 1-4 ARE ENABLE# FUNCTION  
ISL8704A, ISL8705A PIN 9 IS SEQ\_EN# FUNCTION

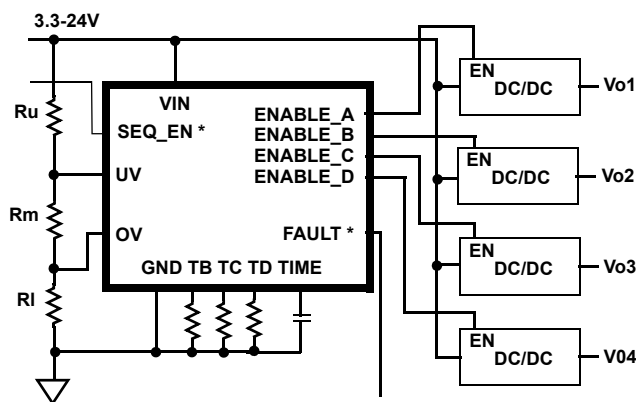

\* SEQ\_EN and FAULT are not available on ISL8700A and ISL8701A

FIGURE 1. ISL870XA IMPLEMENTATION

**Absolute Maximum Ratings**

V <sub>IN</sub> , ENABLE(#), FAULT	27V, to -0.3V
TIME, TB, TC, TD, UV, OV	+6V, to -0.3V
SEQ_EN(#)	V <sub>IN</sub> +0.3V, to -0.3V
ENABLE, ENABLE # Output Current	10mA

**Thermal Information**

Thermal Resistance (Typical, <a href="#">Note 2</a> )	θ <sub>JA</sub> (°C/W)
14 Ld SOIC	110
Maximum Junction Temperature (Plastic Package)	+125°C
Maximum Storage Temperature Range	-65°C to +150°C
Pb-Free Reflow Profile	see <a href="#">TB493</a>

**Operating Conditions**

Temperature Range	-40°C to +85°C
Supply Voltage Range (Nominal)	3.3V to 24V

**CAUTION:** Do not operate at or near the maximum ratings listed for extended periods of time. Exposure to such conditions may adversely impact product reliability and result in failures not covered by warranty.

**NOTE:**

- θ<sub>JA</sub> is measured with the component mounted on a high effective thermal conductivity test board in free air. See Tech Brief [TB379](#) for details.

**Electrical Specifications** Nominal V<sub>IN</sub> = 3.3V to +24V, T<sub>A</sub> = T<sub>J</sub> = -40°C to +85°C, Unless Otherwise Specified.

PARAMETER	SYMBOL	TEST CONDITIONS	MIN	TYP	MAX	UNIT
<b>UV AND OV INPUTS</b>						
UV/OV Rising Threshold	V <sub>UVRvth</sub>		1.16	1.21	1.28	V
UV/OV Falling Threshold	V <sub>UVFvth</sub>		1.06	1.10	1.18	V
UV/OV Hysteresis	V <sub>UVhys</sub>	V <sub>UVRvth</sub> - V <sub>UVFvth</sub>	-	104	-	mV
UV/OV Input Current	I <sub>UV</sub>		-	10	-	nA
<b>TIME, ENABLE/ENABLE# OUTPUTS</b>						
TIME Pin Charging Current	I <sub>TIME</sub>		-	2.6	-	μA
TIME Pin Threshold	V <sub>TIME_VTH</sub>		1.9	2.0	2.25	V
Time from V <sub>IN</sub> Valid to ENABLE_A	t <sub>VINSEQpd</sub>	SEQ_EN = high, C <sub>TIME</sub> = open	-	30	-	μs
	t <sub>VINSEQpd_10</sub>	SEQ_EN = high, C <sub>TIME</sub> = 10nF	-	7.7	-	ms
	t <sub>VINSEQpd500</sub>	SEQ_EN = high, C <sub>TIME</sub> = 500nF	-	435	-	ms
Time from V <sub>IN</sub> Invalid to Shutdown	t <sub>shutdown</sub>	UV or OV to simultaneous shutdown	-	-	1	μs
ENABLE Output Resistance	R <sub>EN</sub>	I <sub>ENABLE</sub> = 1mA	-	100	-	Ω
ENABLE Output Low	V <sub>ol</sub>	I <sub>ENABLE</sub> = 1mA	-	0.1	-	V
ENABLE Pull-down Current	I <sub>pullD</sub>	ENABLE = 1V	10	15	-	mA
Delay to Subsequent ENABLE Turn-on/off	t <sub>del_120</sub>	R <sub>TX</sub> = 120kΩ	155	195	240	ms
	t <sub>del_3</sub>	R <sub>TX</sub> = 3kΩ	3.5	4.7	6	ms
	t <sub>del_0</sub>	R <sub>TX</sub> = 0Ω	-	0.5	-	ms
<b>SEQUENCE ENABLE AND FAULT I/O</b>						
V <sub>IN</sub> Valid to FAULT Low	t <sub>FLTL</sub>		15	30	50	μs
V <sub>IN</sub> Invalid to FAULT High	t <sub>FLTH</sub>		-	0.5	-	μs
FAULT Pull-down Current		FAULT = 1V	10	15	-	mA
SEQ_EN Pull-up Voltage	V <sub>SEQ</sub>	SEQ_EN open	-	2.4	-	V
SEQ_EN Low Threshold Voltage	V <sub>ilSEQ_EN</sub>		-	-	0.3	V
SEQ_EN High Threshold Voltage	V <sub>ihSEQ_EN</sub>		1.2	-	-	V
Delay to ENABLE_A Deasserted	t <sub>SEQ_EN_ENA</sub>	SEQ_EN low to ENABLE_A low	-	0.2	1	μs
<b>BIAS</b>						
IC Supply Current	I <sub>VIN_3.3V</sub>	V <sub>IN</sub> = 3.3V	-	191	-	μA
	I <sub>VIN_12V</sub>	V <sub>IN</sub> = 12V	-	246	400	μA
	I <sub>VIN_24V</sub>	V <sub>IN</sub> = 24V	-	286	-	μA
V <sub>IN</sub> Power On Reset	V <sub>IN_POR</sub>	V <sub>IN</sub> low to high	-	2.3	2.8	V

**Pin Descriptions**

PINS						PIN NAME	FUNCTION DESCRIPTION
8700A	8701A	8702A	8703A	8704A	8705A		
NA	1	NA	1	NA	1	ENABLE#_D	Active low open drain sequenced output. Sequenced on after ENABLE#_C and first output to sequence off for the ISL8701A, ISL8703A, ISL8705A. Tracks $V_{IN}$ upon bias.
1	NA	1	NA	1	NA	ENABLE_D	Active high open drain sequenced output. Sequenced on after ENABLE#_C and first output to sequence off for the ISL8700A, ISL8702A, ISL8704A. Pulls low with $V_{IN} < 1V$ .
NA	2	NA	2	NA	2	ENABLE#_C	Active low open drain sequenced output. Sequenced on after ENABLE#_B and sequenced off after ENABLE#_D for the ISL8701A, ISL8703A, ISL8705A. Tracks $V_{IN}$ upon bias.
2	NA	2	NA	2	NA	ENABLE_C	Active high open drain sequenced output. Sequenced on after ENABLE#_B and sequenced off after ENABLE#_D for the ISL8700A, ISL8702A, ISL8704A. Pulls low with $V_{IN} < 1V$ .
NA	3	NA	3	NA	3	ENABLE#_B	Active low open drain sequenced output. Sequenced on after ENABLE#_A and sequenced off after ENABLE#_C for the ISL8701A, ISL8703A, ISL8705A. Tracks $V_{IN}$ upon bias.
3	NA	3	NA	3	NA	ENABLE_B	Active high open drain sequenced output. Sequenced on after ENABLE#_A and sequenced off after ENABLE#_C for the ISL8700A, ISL8702A, ISL8704A. Pulls low with $V_{IN} < 1V$ .
NA	4	NA	4	NA	4	ENABLE#_A	Active low open drain sequenced output. Sequenced on after CTIME period and sequenced off after ENABLE#_B for the ISL8701A, ISL8703A, ISL8705A. Tracks $V_{IN}$ upon bias.
4	NA	4	NA	4	NA	ENABLE_A	Active high open drain sequenced output. Sequenced on after CTIME period and sequenced off after ENABLE#_B for the ISL8700A, ISL8702A, ISL8704A. Pulls low with $V_{IN} < 1V$ .
5	5	5	5	5	5	OV	The voltage on this pin must be under its 1.22V $V_{th}$ or the four ENABLE outputs will be immediately pulled down. Conversely the 4 ENABLE# outputs will be released to be pulled high via external pull-ups.
6	6	6	6	6	6	UV	The voltage on this pin must be over its 1.22V $V_{th}$ or the four ENABLE outputs will be immediately pulled down. Conversely the 4 ENABLE# outputs will be released to be pulled high via external pull-ups.
7	7	7	7	7	7	GND	IC ground.
NA	NA	8	8	8	8	FAULT	The $V_{IN}$ voltage when not within the desired UV to OV window will cause FAULT to be released to be pulled high to a voltage equal to or less than $V_{IN}$ via an external resistor.
NA	NA	9	9	NA	NA	SEQ_EN	This pin provides a sequence on signal input with a high input. Internally pulled high to $\sim 2.4V$ .
NA	NA	NA	NA	9	9	SEQ_EN#	This pin provides a sequence on signal input with a low input. Internally pulled high to $\sim 2.4V$ .
10	10	10	10	10	10	TIME	This pin provides a 2.6 $\mu A$ current output so that an adjustable $V_{IN}$ valid to sequencing on and off start delay period is created with a capacitor to ground.
11	11	11	11	11	11	TB	A resistor connected from this pin to ground determines the time delay from ENABLE_A being active to ENABLE_B being active on turn-on and also going inactive on turn-off via the SEQ_IN input.
12	12	12	12	12	12	TC	A resistor connected from this pin to ground determines the time delay from ENABLE_B being active to ENABLE_C being active on turn-on and also going inactive on turn-off via the SEQ_IN input.
13	13	13	13	13	13	TD	A resistor connected from this pin to ground determines the time delay from ENABLE_C being active to ENABLE_D being active on turn-on and also going inactive on turn-off via the SEQ_IN input.
14	14	14	14	14	14	$V_{IN}$	IC Bias Pin Nominally 3.3V to 24V This pin requires a 1 $\mu F$ decoupling capacitor close to IC pin.

## Functional Block Diagram

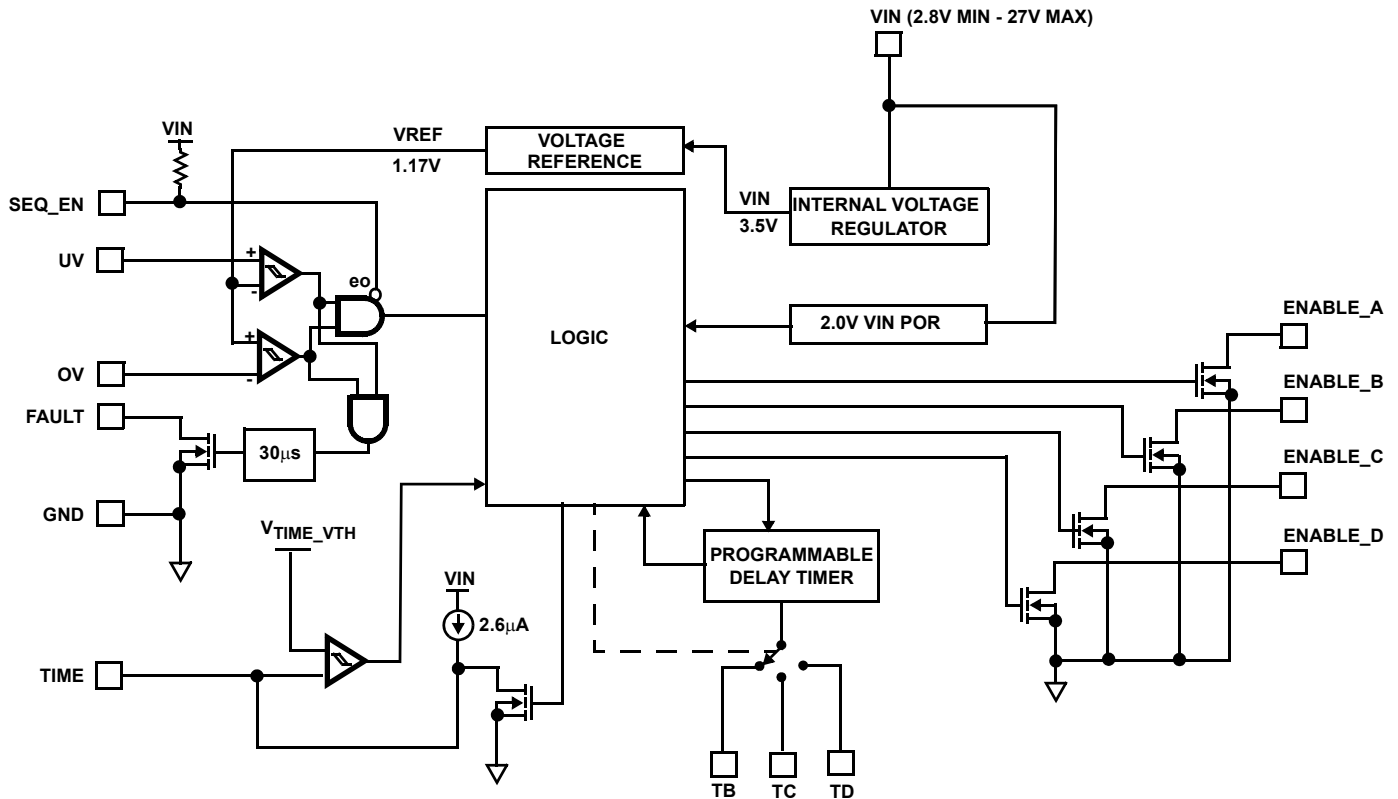

## Functional Description

The ISL870XA family of ICs provides four delay adjustable sequenced outputs while monitoring a single distributed voltage in the nominal range of 3.3V to 24V for both under and overvoltage. Only when the voltage is in compliance will the ISL870XA initiate the pre-programmed A-B-C-D sequence of the ENABLE (ISL8700A, ISL8702A, ISL8704A) or ENABLE# (ISL8701A, ISL8703A, ISL8705A) outputs. Although this IC has a bias range of 3.3V to 24V it can monitor any voltage  $>1.22V$  via the external divider if a suitable bias voltage is otherwise provided.

During initial bias voltage ( $V_{IN}$ ) application the ISL8700A, ISL8702A, ISL8704A ENABLE outputs are held low once  $V_{IN} = 1V$  whereas the ISL8701A, ISL8703A, ISL8705A ENABLE# outputs follow the rising  $V_{IN}$ . Once  $V_{IN} > V$  bias power on reset threshold (POR) of 2.8V,  $V_{IN}$  is constantly monitored for compliance via the input voltage resistor divider and the voltages on the UV and OV pins and reported by the FAULT output. Internally, voltage regulators generate 3.5V and 1.17V  $\pm 5\%$  voltage rails for internal usage once  $V_{IN} > POR$ . Once  $UV > 1.22V$  and with the SEQ\_EN pin high or open, (SEQ\_EN# must be pulled low on ISL8704A, ISL8705A) the auto sequence of the four ENABLE (ENABLE#) outputs begins as the TIME pin charges its external capacitor with a 2.6 $\mu A$  current source. The voltage on TIME is compared to the internal reference ( $V_{TIME\_VTH}$ ) comparator input and when

greater than  $V_{TIME\_VTH}$  the ISL8700A, ISL8702A, ISL8704A ENABLE\_A is released to go high via an external pull-up resistor or a pull-up in a DC/DC converter enable input, for example. Conversely, ENABLE#\_A output will be pulled low at this time on an ISL8701A, ISL8703A, ISL8705A. The time delay generated by the external capacitor is to assure continued voltage compliance within the programmed limits, as during this time any OV or UV condition will halt the start-up process. TIME cap is discharged once  $V_{TIME\_VTH}$  is met.

Once ENABLE\_A is active (either released high on the ISL8700A, ISL8702A, ISL8704A or pulled low, ISL8701A, ISL8703A, ISL8705A) a counter is started and using the resistor on TB as a timing component a delay is generated before ENABLE\_B is activated. At this time, the counter is restarted using the resistor on TC as its timing component for a separate timed delay until ENABLE\_C is activated. This process is repeated for the resistor on TD to complete the A-B-C-D sequencing order of the ENABLE or ENABLE# outputs. At any time during sequencing if an OV or UV event is registered, all four ENABLE outputs will immediately return to their reset state; low for ISL8700A, ISL8702A, ISL8704A and high for ISL8701A, ISL8703A, ISL8705A.  $C_{TIME}$  is immediately discharged after initial ramp up thus waiting for subsequent voltage compliance to restart. Once sequencing is complete, any subsequently registered UV or OV event will trigger an immediate and simultaneous reset of all ENABLE or ENABLE# outputs.

On the ISL8702A, ISL8703A, ISL8704A and ISL8705A, enabling of on or off sequencing can also be signaled via the SEQ\_EN or SEQ\_EN# input pin once voltage compliance is met. Initially, the SEQ\_EN pin should be held low and released when sequence start is desired. The SEQ# is internally pulled high and sequencing is enabled when it is pulled low. The on sequence of the ENABLE outputs is as previously described. The off sequence feature is only available on the variants having the SEQ\_EN or the SEQ\_EN# inputs, these being the ISL8702A, ISL8703A, ISL8704A, ISL8705A. The sequence is D off, then C off, then B off and finally A off. Once SEQ\_EN (SEQ\_EN#) is signaled low (high), the TIME cap is charged to 2V once again. Once this  $V_{th}$  is reached, ENABLE\_D transitions to its reset state and CTIM is discharged. A delay and subsequent sequence off is then determined by TD resistor to ENABLE\_C. Likewise, a delay to ENABLE\_B and then ENABLE\_A turn-off is determined by TC and TB resistor values respectively.

With the ISL8700A, ISL8701A a quasi down sequencing of the ENABLE outputs can be achieved by loading the ENABLE pins with various value capacitors to ground. When a simultaneous output latch off is invoked, the caps will set the falling ramp of the various ENABLE outputs thus adjusting the time to  $V_{th}$  for various DC/DC convertors or other circuitry.

Regardless of IC variant, the FAULT signal is always valid at operational voltages and can be used as justification for SEQ\_EN release or even controlled with an RC timer for sequence on.

### Programming the Under and Overvoltage Limits

When choosing resistors for the divider remember to keep the current through the string bounded by power loss at the top end and noise immunity at the bottom end. For most applications, total divider resistance in the 10k $\Omega$  to 1000k $\Omega$  range is advisable with high precision resistors being used to reduce monitoring error. Although for the ISL870XA, two dividers of two resistors each can be employed to separately monitor the OV and UV levels for the  $V_{IN}$  voltage. We will discuss using a single three resistor string for monitoring the  $V_{IN}$  voltage, referencing [Figure 1](#). In the three resistor divider string with  $R_u$  (upper),  $R_m$  (middle) and  $R_l$  (lower), the ratios of each in combination to the other two is balanced to achieve the desired UV and OV trip levels. Although this IC has a bias range of 3.3V to 24V, it can monitor any voltage >1.22V.

The ratio of the desired overvoltage trip point to the internal reference is equal to the ratio of the two upper resistors to the lowest (gnd connected) resistor.

The ratio of the desired undervoltage trip point to the internal reference voltage is equal to the ratio of the uppermost (voltage connected) resistor to the lower two resistors.

These assumptions are true for both rising (turn-on) or falling (shutdown) voltages.

The following is a practical example worked out. For detailed equations on how to perform this operation for a given supply

requirement please see the next section.

1. Determine if turn-on or shutdown limits are preferred. In this example, we will determine the resistor values based on the shutdown limits.
2. Establish lower and upper trip level: 12V  $\pm$ 10% or 13.2V (OV) and 10.8V (UV)
3. Establish total resistor string value: 100k $\Omega$ ,  $I_r$  = divider current, 1.1V is falling 1.2V is rising threshold.
4.  $(R_m+R_l) \times I_r = 1.1V$  at UV and  $R_l \times I_r = 1.2V$  at OV
5.  $R_m+R_l = 1.1V/I_r$  at UV =  $R_m+R_l = 1.1V/(10.8V/100k\Omega) = 10.185k\Omega$
6.  $R_l = 1.2V/I_r$  at OV =  $R_l = 1.2V/(13.2V/100k\Omega) = 9.09k\Omega$
7.  $R_m = 10.185k\Omega - 9.09k\Omega = 1.095k\Omega$
8.  $R_u = 100k\Omega - 10.185k\Omega = 89.815k\Omega$
9. Choose standard value resistors that most closely approximate these ideal values. Choosing a different total divider resistance value may yield a more ideal ratio with available resistor's values.

In our example, with the closest standard values of  $R_u = 90.9k\Omega$ ,  $R_m = 1.13k\Omega$  and  $R_l = 9.31k\Omega$ , the nominal UV falling and OV rising will be at 10.9V and 13.3V respectively.

### Programming the ENABLE Output Delays

The delay timing between the four sequenced ENABLE outputs are programmed with four external passive components. The delay from a valid  $V_{IN}$  (ISL8700A and ISL8701A) to ENABLE\_A and SEQ\_EN being valid (ISL8702A, ISL8703A, ISL8704A, ISL8705A) to ENABLE\_A is determined by the value of the capacitor on the TIME pin to GND. The external TIME pin capacitor is charged with a 2.6 $\mu$ A current source. Once the voltage on TIME is charged up to the internal reference voltage, ( $V_{TIME\_VTH}$ ) the ENABLE\_A output is released out of its reset state. The capacitor value for a desired delay ( $\pm$ 10%) to ENABLE\_A once  $V_{IN}$  and SEQ\_EN where applicable has been satisfied is determined by:

$$C_{TIME} = t_{VINSEQpd}/770k\Omega$$

Once ENABLE\_A reaches  $V_{TIME\_VTH}$ , the TIME pin is pulled low in preparation for a sequenced off signal via SEQ\_EN. At this time, the sequencing of the subsequent outputs is started. ENABLE\_B is released out of reset after a programmable time, then ENABLE\_C, then ENABLE\_D, all with their own programmed delay times.

The subsequent delay times are programmed with a single external resistor for each ENABLE output providing maximum flexibility to the designer through the choice of the resistor value connected from TB, TC and TD pins to GND. The resistor values determine the charge and discharge rate of an internal capacitor comprising an RC time constant for an oscillator whose output is fed into a counter generating the timing delay to ENABLE output sequencing.

The  $R_{TX}$  value for a given delay time is defined as:

$$R_{TX} = t_{del}/1667nF$$

**An Advanced Tutorial on Setting UV and OV Levels**

This section discusses in additional detail the nuances of setting the UV and OV levels, providing more insight into the ISL870XA than the earlier text.

The following equation set can alternatively be used to work out ideal values for a 3 resistor divider string of Ru, Rm and RI.

These equations assume that VREF is the center point between VUVRvth and VUVFvth (i.e. (VUVRvth + VUVFvth)/2 = 1.17V), Iload is the load current in the resistor string (i.e. VIN/(Ru + Rm + RI)), VIN is the nominal input voltage and Vtol is the acceptable voltage tolerance, such that the UV and OV thresholds are centered at VIN ± Vtol. The actual acceptable voltage window will also be affected by the hysteresis at the UV and OV pins. This hysteresis is amplified by the resistor string such that the hysteresis at the top of the string is:

$$V_{hys} = V_{UVhys} \times V_{OUT}/V_{REF}$$

This means that the VIN ± Vtol thresholds will exhibit hysteresis resulting in thresholds of VIN + Vtol ± Vhys/2 and VIN - Vtol ± Vhys/2.

There is a window between the VIN rising UV threshold and the VIN falling OV threshold where the input level is guaranteed not to be detected as a fault. This window exists between the limits VIN ± (Vtol - Vhys/2). There is an extension of this window in each direction up to VIN ± (Vtol + Vhys/2), where the voltage may or may not be detected as a fault, depending on the direction from which it is approached. These two equations may be used to determine the required value of Vtol for a given system. For example, if VIN is 12V, Vhys = (0.1 x 12)/1.17 = 1.03V. If VIN must remain within 12V ± 1.5V, Vtol = 1.5 - 1.03/2 = 0.99V.

This will give a window of 12 ± 0.48V where the system is guaranteed not to be in fault and a limit of 12 ± 1.5V beyond which the system is guaranteed to be in fault.

It is wise to check both these voltages, for if the latter is made too tight, the former will cease to exist. This point comes when Vtol < Vhys/2 and results from the fact that the acceptable window for the OV pin no longer aligns with the acceptable window for the UV pin. In this case, the application will have to be changed such that UV and OV are provided separate resistor strings. In this case, the UV and OV thresholds can be individually controlled by adjusting the relevant divider.

The previous example will give voltage thresholds of:

with VIN rising

$$UVr = V_{IN} - V_{tol} + V_{hys}/2 = 11.5V \text{ and}$$

$$OVR = V_{IN} + V_{tol} + V_{hys}/2 = 13.5V$$

with VIN falling

$$OVf = V_{IN} + V_{tol} - V_{hys}/2 = 12.5V \text{ and}$$

$$UVf = V_{IN} - V_{tol} - V_{hys}/2 = 10.5V.$$

So with a single three resistor string, the resistor values can be calculated as:

$$RI = (V_{REF}/I_{load}) (1 - V_{tol}/V_{IN})$$

$$Rm = 2(V_{REF} \times V_{tol})/(V_{IN} \times I_{load})$$

$$Ru = 1/I_{load} \times (V_{IN} - V_{REF} (1 + V_{tol}/V_{IN}))$$

For the above example, with Vtol = 0.99V, assuming a 100µA Iload at VIN = 12V:

$$RI = 10.7k\Omega$$

$$Rm = 1.9k\Omega$$

$$Ru = 107.3k\Omega$$

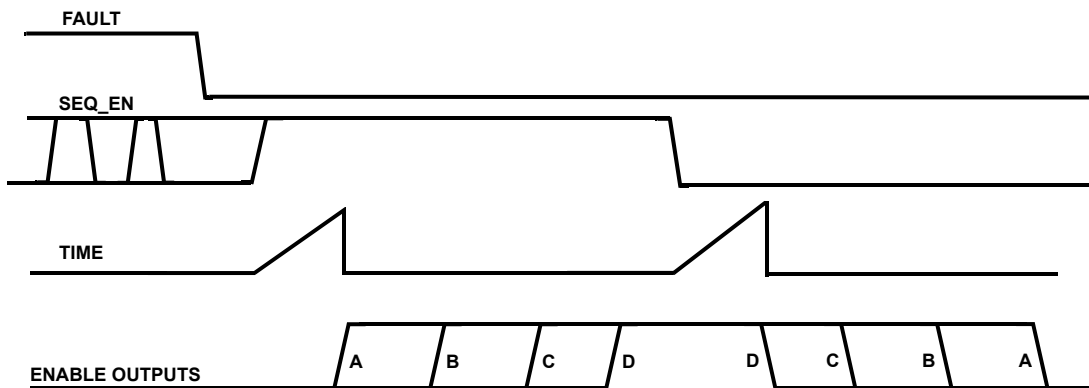

FIGURE 2. ISL8702A OPERATIONAL DIAGRAM

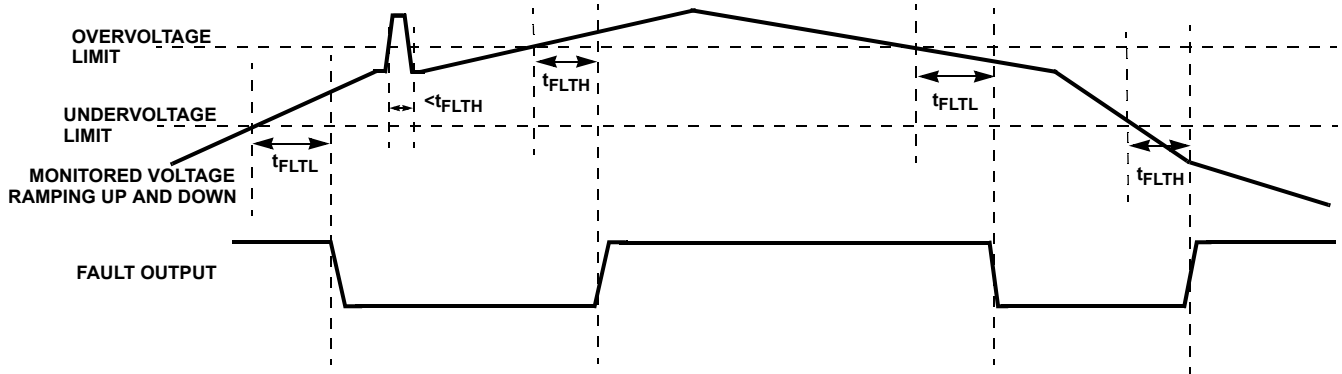

FIGURE 3. ISL8702A, ISL8703A, ISL8704A, ISL8705A FAULT OPERATIONAL DIAGRAM

### Typical Performance Curves

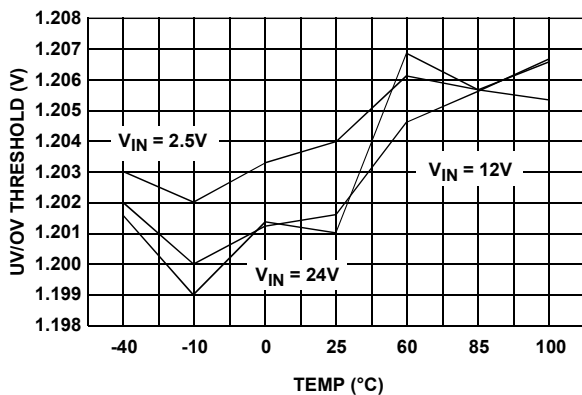

FIGURE 4. UV/OV RISING THRESHOLD

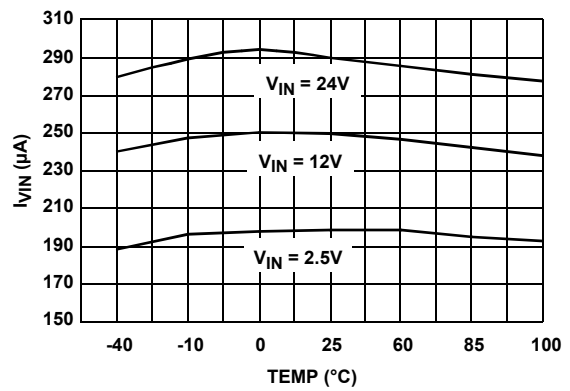

FIGURE 5.  $V_{IN}$  CURRENT

### Applications Usage

#### Using the ISL870XAEVAL1 Platform

The ISL870XAEVAL1 platform is the primary evaluation board for this family of sequencers. See [Figure 16](#) for photograph and schematic. The evaluation board is shipped with an **ISL8702A** mounted in the left position and with the other device variants loose packed. In the following discussion, test points names are **bold** on initial occurrence for identification.

The  **$V_{IN}$**  test point is the chip bias and can be biased from 3.3V to 24V. The **VHI** test point is for the ENABLE and **FAULT** pull-up voltage which are limited to a maximum of 24V independent of  $V_{IN}$ . The UV/OV resistor divider is set so that a nominal 12V on the **VMONITOR** test point is compliant and with a rising OV set at 13.2V and a falling UV set at 10.7V. These three test points ( **$V_{IN}$** , **VHI** and **VMONITOR**) are brought out separately for maximum flexibility in evaluation.

**VMONITOR** ramping up and down through the UV and OV levels will result in the **FAULT** output signaling the out of bound conditions by being released to pull high to the **VHI** voltage as shown in [Figures 6](#) and [7](#).

Once the voltage monitoring **FAULT** is resolved and where applicable, the **SEQ\_EN(#)** is satisfied, sequencing of the **ENABLE\_X(#)** outputs begins. When sequence enabled the **ENABLE\_A**, **ENABLE\_B**, **ENABLE\_C** and lastly **ENABLE\_D** are asserted in that order and when **SEQ\_EN** is disabled the order is reversed. See [Figures 8](#) and [9](#) demonstrating the sequenced enabling and disabling of the **ENABLE** outputs. The timing between **ENABLE** outputs is set by the resistor values on the **TB**, **TC**, **TD** pins as shown. [Figure 10](#) illustrates the timing from either **SEQ\_EN** and/or **VMONITOR** being valid to **ENABLE\_A** being asserted with a 10nF **TIME** capacitor. [Figure 11](#) shows that **ENABLE\_X** outputs are pulled low even before  $V_{IN} = 1V$ . This is critical to ensure that a false enable is not signaled. [Figure 12](#) illustrates the **SEQ\_EN#** input disabling and enabling the ISL8705A **ENABLE#** outputs. Notice the reversal in order and delay timing from **ENABLE\_X#** to **ENABLE\_X#**. [Figure 13](#) shows the time from **SEQ\_EN** transition with the voltage ramping across the **TIME** capacitor to **TIME**  $V_{th}$  being met. This results in the immediate pull down of the **TIME** pin and simultaneous **ENABLE\_A** enabling.

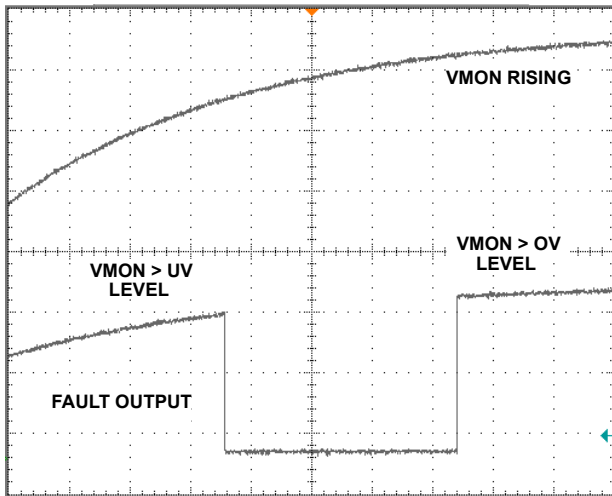

FIGURE 6. VMONITOR RISING TO FAULT

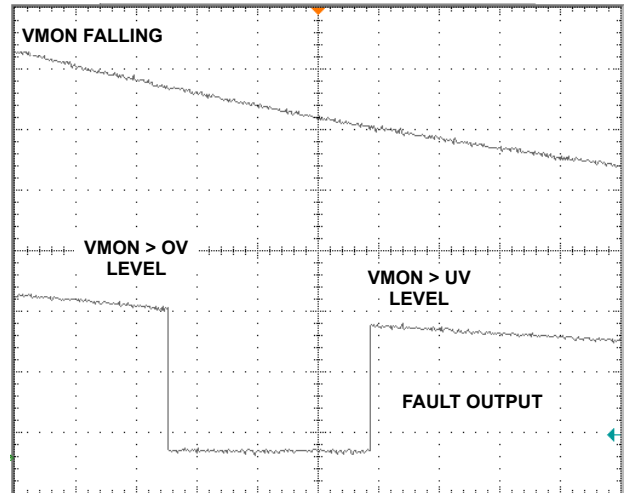

FIGURE 7. VMONITOR FALLING TO FAULT

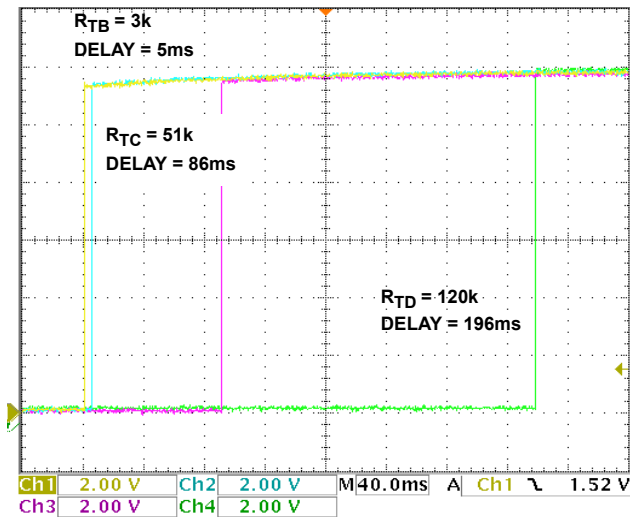

FIGURE 8. ENABLE\_X TO ENABLE\_X ENABLING

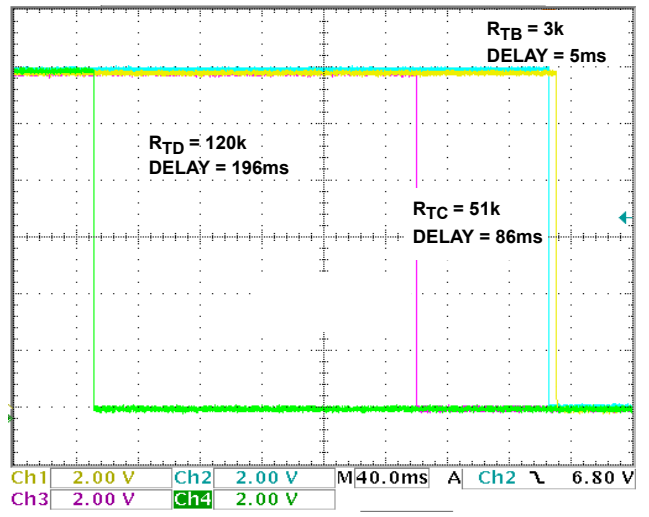

FIGURE 9. ENABLE\_X TO ENABLE\_X DISABLING

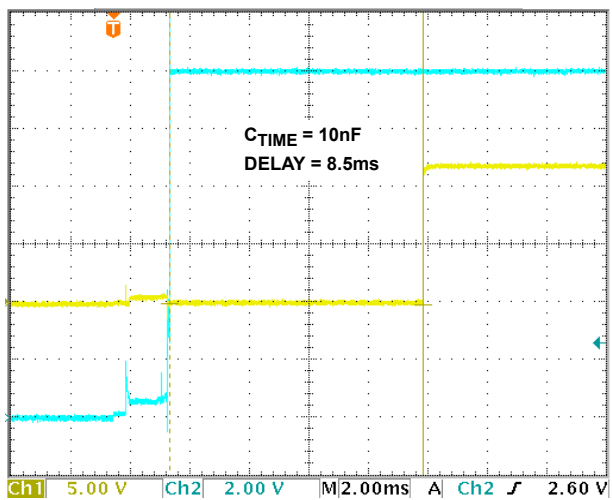

FIGURE 10.  $V_{IN}/SEQ\_EN$  VALID TO ENABLE\_A

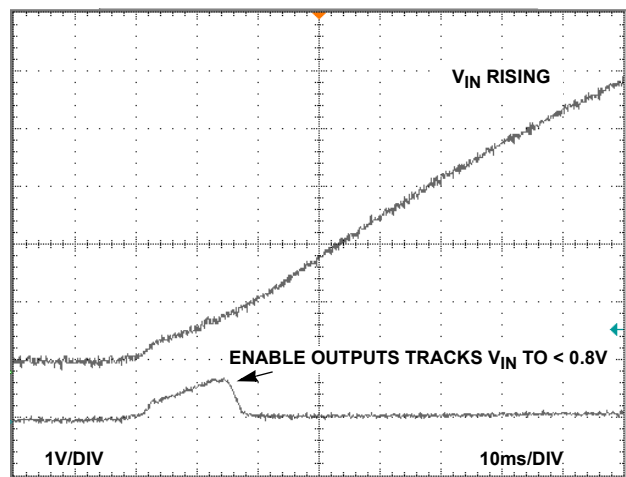

FIGURE 11. ENABLE AS  $V_{IN}$  RISES



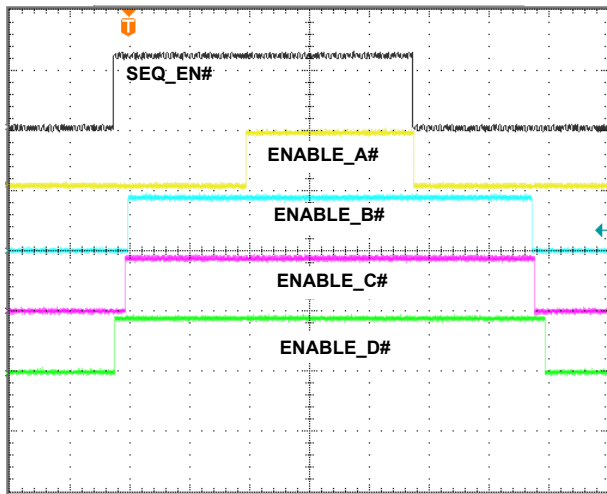

FIGURE 12. ISL8705A ENABLE\_X# TO ENABLE\_X#

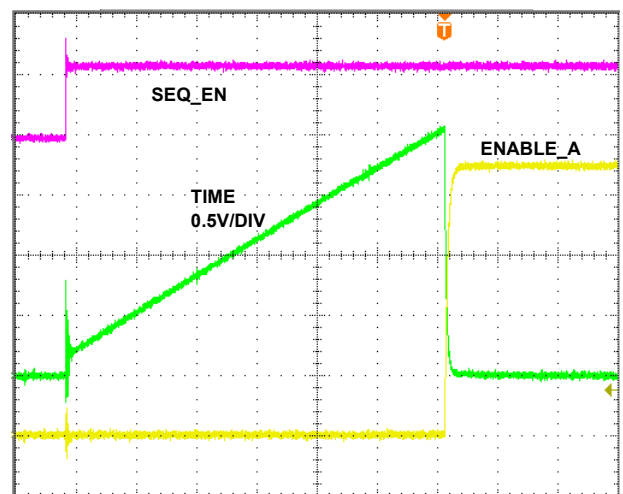

FIGURE 13. SEQ\_EN TO ENABLE\_A

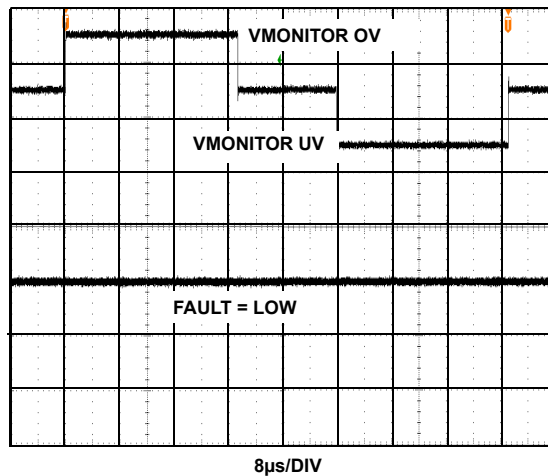

FIGURE 14. OV AND UV TRANSIENT IMMUNITY

### Application Recommendations

Best practices  $V_{IN}$  decoupling is required, a  $1\mu\text{F}$  capacitor is recommended.

Coupling from the ENABLE\_X pins to the sensitive UV and OV pins can cause false OV/UV events to be detected. This is most relevant for ISL8700A, ISL8702A, ISL8704A parts due to the ENABLEA and OV pins being adjacent. This coupling can be reduced by adding a ground trace between UV and the ENABLE/FAULT signals, as shown in [Figure 15](#). The PCB traces on OV and UV should be kept as small as practical and the ENABLE\_X and FAULT traces should ideally not be routed under/over the OV/UV traces on different PCB layers unless there is a ground or power plane in between. Other methods that can be used to eliminate this issue are by reducing the value of the resistors in the network connected to UV and OV ( $R_2$ ,  $R_3$ ,  $R_5$  in [Figure 16](#)) or by adding small decoupling capacitors to OV and UV ( $C_2$  and  $C_7$  in [Figure 16](#)). Both these methods act to reduce the AC impedance at the nodes, although the latter method acts

to filter the signals which will also cause an increase in the time that a UV/OV fault takes to be detected.

When the ISL870XA is implemented on a hot swappable card that is plugged into an always powered passive back plane an RC filter is required on the  $V_{IN}$  pin to prevent a high  $dv/dt$  transient. With the already existing  $1\mu\text{F}$  decoupling capacitor the addition of a small series R ( $>50\Omega$ ) to provide a time constant  $>50\mu\text{s}$  is all that is necessary.



TABLE 1. ISL870XAEVAL1 LEFT CHANNEL COMPONENT LISTING

COMPONENT DESIGNATOR	COMPONENT FUNCTION	COMPONENT DESCRIPTION
U1	ISL8702A, Quad Under/Overvoltage Sequencer	Intersil, ISL8702A, Quad Under/Overvoltage Sequencer
R3	UV Resistor for Divider String	1.1k $\Omega$ 1%, 0603
R2	VMONITOR Resistor for Divider String	88.7k $\Omega$ 1%, 0603
R5	OV Resistor for Divider String	9.1k $\Omega$ 1%, 0603
C1	C <sub>TIME</sub> Sets Delay from Sequence Start to First ENABLE	0.01 $\mu$ F, 0603
R1	R <sub>TD</sub> Sets Delay from Third to Fourth ENABLE	120k $\Omega$ 1%, 0603
R9	R <sub>TB</sub> Sets Delay from First to Second ENABLE	3.01k $\Omega$ 1%, 0603
R7	R <sub>TC</sub> Sets Delay from Second to Third ENABLE	51k $\Omega$ 1%, 0603
R4, R6, R8, R10, R11	ENABLE_X(#) and FAULT Pull-up Resistors	4k $\Omega$ 10%, 0402
C3	Decoupling Capacitor	1 $\mu$ F, 0603

© Copyright Intersil Americas LLC 2006-2014. All Rights Reserved.  
All trademarks and registered trademarks are the property of their respective owners.

For additional products, see [www.intersil.com/en/products.html](http://www.intersil.com/en/products.html)

Intersil products are manufactured, assembled and tested utilizing ISO9001 quality systems as noted in the quality certifications found at [www.intersil.com/en/support/qualandreliability.html](http://www.intersil.com/en/support/qualandreliability.html)

*Intersil products are sold by description only. Intersil may modify the circuit design and/or specifications of products at any time without notice, provided that such modification does not, in Intersil's sole judgment, affect the form, fit or function of the product. Accordingly, the reader is cautioned to verify that datasheets are current before placing orders. Information furnished by Intersil is believed to be accurate and reliable. However, no responsibility is assumed by Intersil or its subsidiaries for its use; nor for any infringements of patents or other rights of third parties which may result from its use. No license is granted by implication or otherwise under any patent or patent rights of Intersil or its subsidiaries.*

For information regarding Intersil Corporation and its products, see [www.intersil.com](http://www.intersil.com)

# Package Outline Drawing

## M14.15

### 14 LEAD NARROW BODY SMALL OUTLINE PLASTIC PACKAGE

Rev 1, 10/09

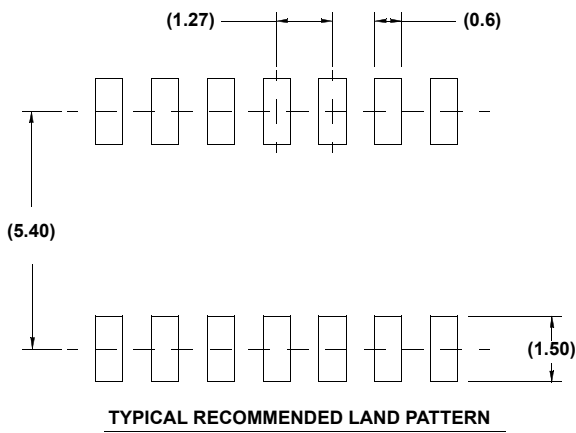
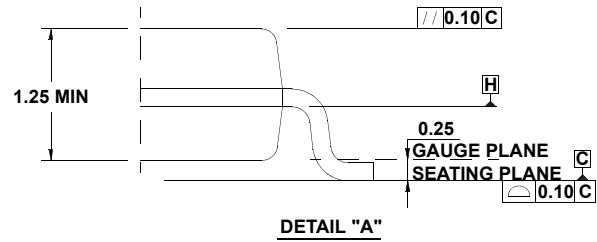
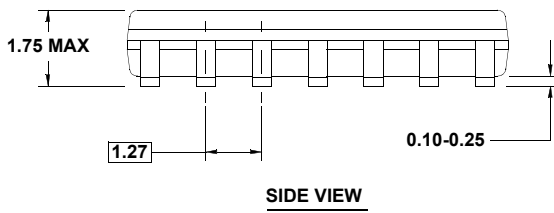
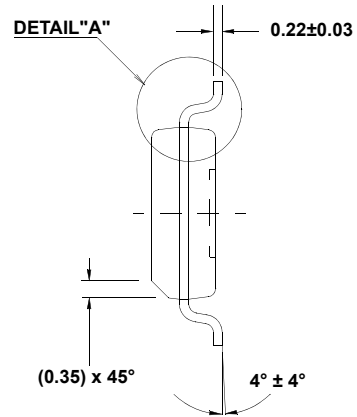
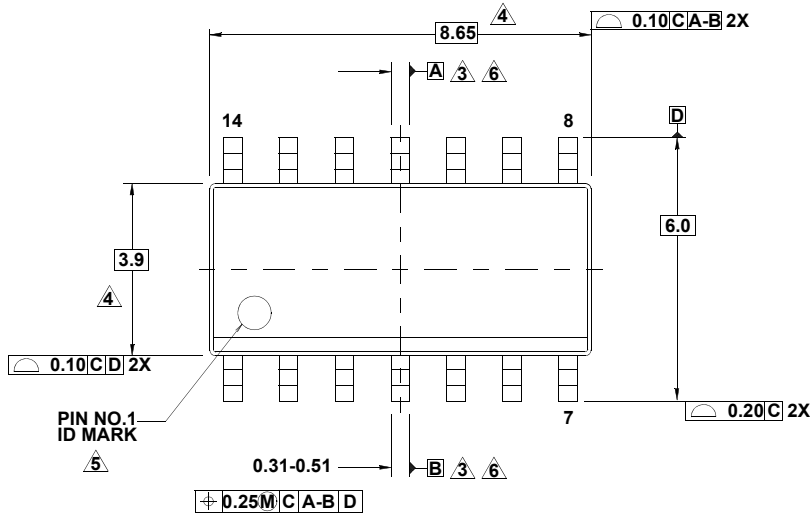

**NOTES:**

1. Dimensions are in millimeters.  
Dimensions in ( ) for Reference Only.
2. Dimensioning and tolerancing conform to AMSEY14.5m-1994.
3. Datums A and B to be determined at Datum H.
4. Dimension does not include interlead flash or protrusions.  
Interlead flash or protrusions shall not exceed 0.25mm per side.
5. The pin #1 identifier may be either a mold or mark feature.
6. Does not include dambar protrusion. Allowable dambar protrusion shall be 0.10mm total in excess of lead width at maximum condition.
7. Reference to JEDEC MS-012-AB.