

AMP\* Crimp Quality Monitor Part No.  
856170-1 and Adapter Kit 856046-1  
(For Use with Side-Feed  
Stripper-Crimper II No. 854040-4)

409-5820  
(was CM 5820)  
03 DEC 93 Rev A

**AMP**

***customer  
manual***



**AMP\* Crimp Quality Monitor Part No. 856170-1  
and Adapter Kit 856046-1  
For Use with Side-Feed Stripper-Crimper II No. 854040-4**

Customer Manual  
**409-5820**  
(was CM 5820)  
03 DEC 93 Rev A

---

# customer manual

Prepared by  
Corporate Standards and Technical Publications  
AMP Incorporated  
P.O. Box 3608  
Harrisburg, PA 17105-3608

## RECEIVING/INSPECTION/INSTALLATION

### RECEIVING

Crimp Quality Monitors are thoroughly inspected during and after assembly. A final series of inspections is made to insure the proper functioning of the monitors before packaging and shipping.

However, damage may occur during shipment. Remove the outer bands from the box and **carefully remove the Crimp Quality Monitor from the box**. Carefully inspect the monitor for damage. If damage is evident, file a claim against the carrier and notify AMP Incorporated immediately.

**NOTE**

*Save the shipping carton/box and the entire documentation packaged shipped with the monitor.*

### INSPECTION

**NOTE**

*A battery and memory test are performed every time the monitor is turned on.*

1. After inspecting for damage, install the power cord, plug the monitor in, and turn the power on. The “heartbeat LED” on the back of the monitor should be flashing and the Main Menu Screen should appear on the monitor.

**NOTE**

*If the LED is not flashing and the Main Menu screen is not visible, refer to Section 5, TROUBLESHOOTING.*

2. Continue with the INSTALLATION instructions.

### INSTALLATION

**NOTE**

*These instructions apply to AMP-O-MATIC\* Stripper-Crimper Model II, Part Number 854040-4. (See 409-5807)*

1. Be sure the Stripper-Crimper II machine is properly installed and set up as described in 409-5807.
2. Install mounting bracket to reel support.
3. Secure the bottom plate of the monitor to the mounting bracket with the four supplied screws.
4. Mount the remote status (light indicator) box using supplied fastener strips. The remote status box should be placed at a location visible to the operator.
5. Attach the 25-position HD connector to I/O port 1J8 of the Crimp Quality Monitor.
6. Install Adapter Kit 856046-1 if the Stripper-Crimper II machine is shipped without the Crimp Quality Monitor. Proceed as follows:
  - a. Remove the four screws securing the adapter kit cover plate.
  - b. Install two dowel pins into pre-drilled holes.
  - c. Install new cover plate.
7. Install the applicator.

**CAUTION**

*The adapter kit contains a delicate sensor. It may be necessary to perform the System Sensor Check as described below.*

8. Connect the ram subassembly to the monitor system.
  - a. Install the DIN connector to the adapter kit. The other end of the cable contains a 15-position HD connector which plugs into the back of the monitor at "APPLICATOR 5J3." See Figure A.

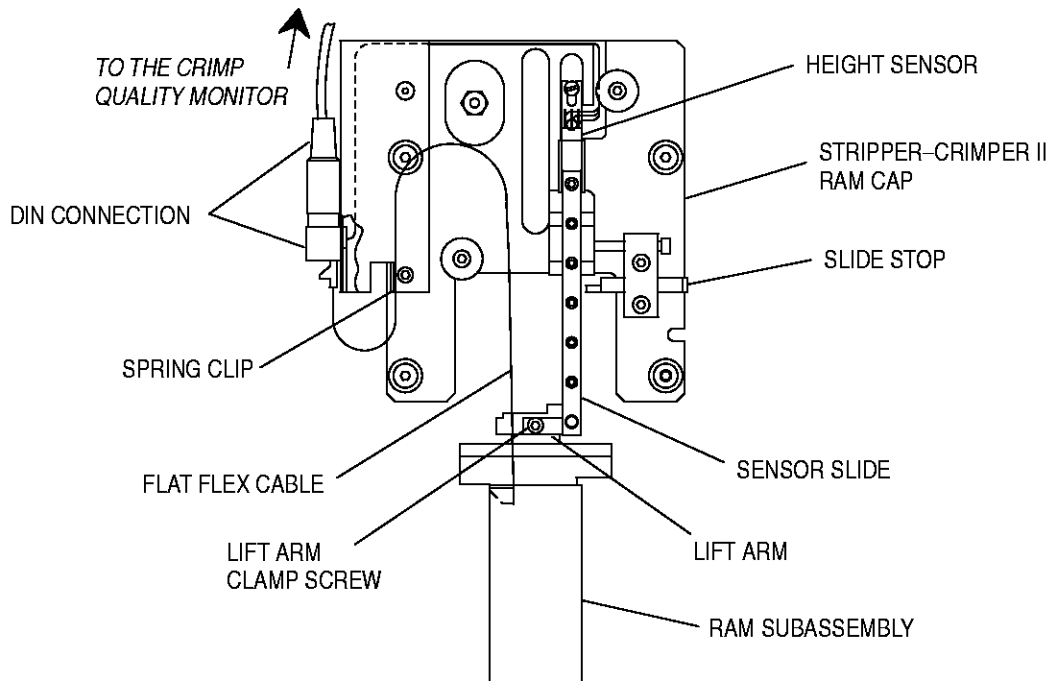

Figure A. Connecting Ram Subassembly to Crimp Quality Monitor System

**CAUTION**

Be certain the the heat shrink pad separates the spring clip and the cable. The cable will wear and "short out" during operation if it is in contact with the spring clip.

- b. Release the slide stop and lower the sensor slide onto the lift arm of the applicator. Secure the sensor slide pin by rotating the slide lock lever. See Figure B.

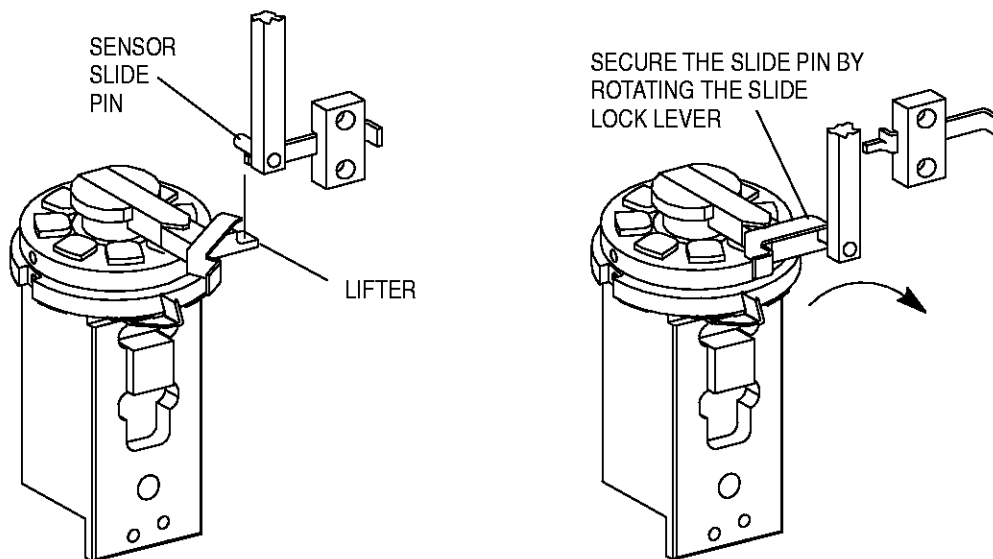

Figure B. Sensor Slide and Lift Arm

9. Connect a printer if desired. Connect cable from the printer serial port to the 1J4 port on the monitor.
10. If using AMP Data Acquisition System (DAS), connect between 1J4 port (or the 1J3 port and RS232-to-RS485 adapter) and the RS232 serial port on the computer. Refer to Paragraph 3.2,G, Printer Serial Port Screen.
11. Connect power cord to the back of the Crimp Quality Monitor.
12. Use the DIAGNOSTICS menu (Paragraph 3.4) to verify the proper operation of the following:
  - a. Sensors (See Systems Sensor Check, below)
  - b. I/O (i.e. red and green lights)
  - c. Printer and DAS (if connected).

## SYSTEM SENSOR CHECK

Perform the system sensor check in the DIAGNOSTIC mode when all cables and sensors are properly connected.

1. Advance the monitor to the SENSOR selection under DIAGNOSTICS, Section 3.4.
2. With tooling in the upper rest position, the screen should show HEIGHT readings from 2000 to 2100 and FORCE readings from 0 to 400. With the tooling under load (lowest position while crimping the smallest wire gage for a given terminal) the readings for the sensors would range from 900 to 2000 for HEIGHT and from 500 to 4000 for FORCE.
3. If the HEIGHT reading is not within the range shown for the under-load condition (lowest position while crimping the smallest wire gage from a given terminal), adjustments can be made by adjusting the lift arm.

**DANGER** *Be sure the power is disconnected when adjusting the lift arm.*

- a. Disconnect power.
- b. Loosen the lift arm clamp screw.
- c. Move lift arm **up** to **increase** reading, or **down** to **decrease** the reading. Thirty counts is approximately .025 mm [.001 in.].
- d. Tighten the lift arm clamp screw.
- e. Connect power and recheck the readings under load.

**NOTE** *If you cannot obtain the proper values, contact AMP Field Engineering for assistance.*

At this point you are ready to supply the monitor with the required information. See Paragraph 3.1.

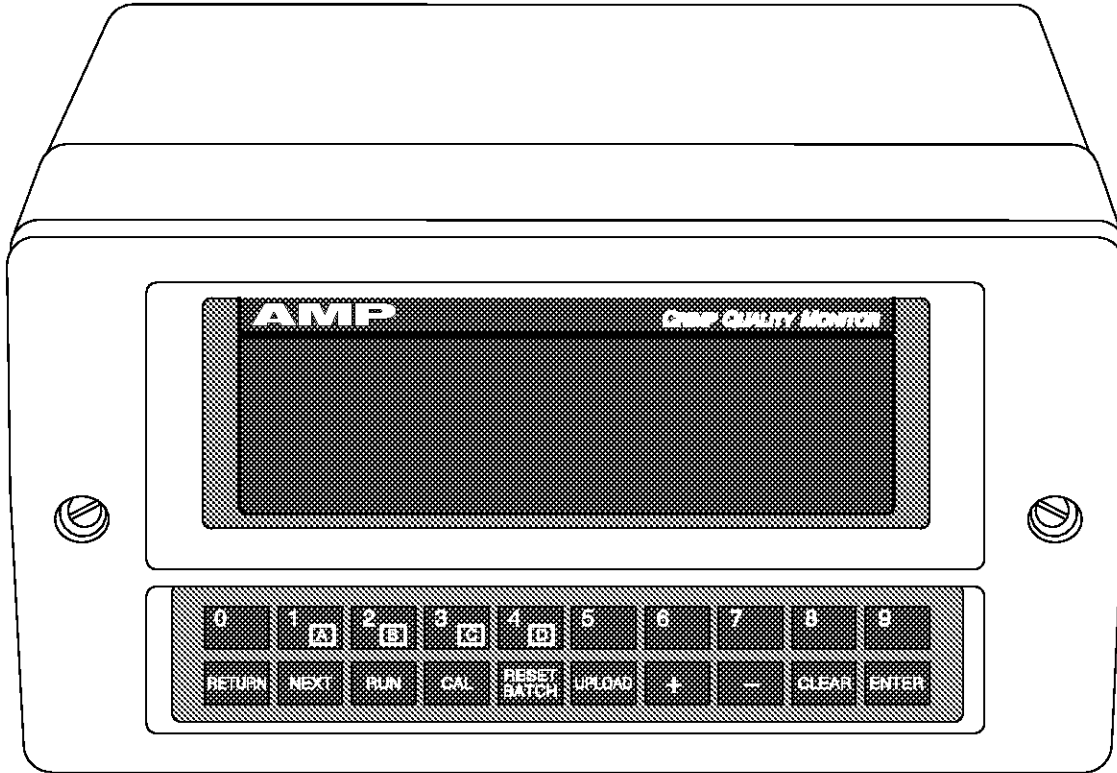

Frontispiece. Crimp Quality Monitor Part Number 856170-[]

200-121E

**DANGER****SAFETY PRECAUTIONS PREVENT INJURY**

Safeguards are designed into AMP machines to protect operating personnel from most hazards during normal machine operation. However, as with most machinery, certain precautions must be taken by the operator and repairman.

Never insert hands into an installed machine/applicator, or any part of a machine that is operated by electricity or compressed air, without first pulling the machine power cable plug from the outlet receptacle and/or shutting off the compressed air at the line valve and disconnecting the air hose. This will prevent injury in the event that switches or other controls are accidentally activated.

A grounded electrical outlet should always be used to receive the plug on the machine power cable.

To improve clarity, photographs and drawings may not show machine/applicator guards. In some cases, it is impractical to show the variety of guards designed to meet specific safety requirements, as set forth in codes and standards adopted by customers and/or enforced in a given locale.

Though a guard may not be shown, and procedures may not reflect the need for its removal, the guard **must** be in place during normal operation of the machine/applicator.

**TOOLING ASSISTANCE CENTER****CALL TOLL FREE 1-800-722-1111****(CONTINENTAL UNITED STATES AND PUERTO RICO ONLY)****GENERAL MACHINE POLICY**

All machines remain the property of AMP Incorporated. The customer shall have no title to the machine(s) and his interest shall be limited to the use of said machine(s) for the purpose indicated, during the stated term, at the specified plant.

No major change or modification shall be made without written consent of AMP Incorporated. Spare and component parts are available at nominal prices.

A list of component parts is included in the instructional material or drawings supplied with each machine.

The customer shall be fully responsible for the maintenance of the machine(s) including servicing, repair, and replacement of damaged or broken parts. Each machine shall be returned in usable condition — reasonable wear and tear excepted. Before returning the machine, contact AMP Incorporated, Harrisburg, Pennsylvania requesting instructions for shipping and disposition.

AMP Field Service Engineers are available to provide assistance in the adjustment or repair of the machine when problems arise which your maintenance personnel are unable to correct. Contact AMP Incorporated Service Products Business for applicable fees.

**INFORMATION REQUIRED WHEN CONTACTING SERVICE PRODUCTS BUSINESS**

AMP Service Products Business offers the **Tooling Assistance Center** as a means of providing technical assistance when required.

When contacting AMP Service Products Business by telephone regarding service to a machine or tool, it is suggested that a person familiar with the device be present with a copy of the manual (and drawings) to receive instructions. Many difficulties can be corrected in this manner.

When calling the Tooling Assistance Center, be ready with the following information:

1. Customer name
2. Customer address
3. Person to contact (name, title, telephone number and extension)
4. Person calling
5. Machine or tool number (and serial number if applicable)
6. Product part number (and serial number if applicable)
7. Urgency of request
8. Nature of problem
9. Description of inoperative component(s)
10. Additional information/comments that may be helpful



# CONTENTS

<b>1. INTRODUCTION</b> .....	1
1.1. The Monitor .....	1
1.2. The Manual .....	1
1.3. The Crimp Quality Monitor Interface .....	1
<b>2. OPERATION</b> .....	5
2.1. Basic Outline of Operation .....	5
2.2. Calibration .....	6
2.3. Run Mode .....	8
<b>3. CRIMP QUALITY MONITOR MENUS</b> .....	10
3.1. Edit Menu .....	10
3.2. Configuration Menu .....	14
3.3. Statistics Menu .....	26
3.4. Diagnostics Menu .....	28
<b>4. CRIMP QUALITY MONITOR MAINTENANCE/REPAIR</b> .....	33
4.1. Daily Maintenance .....	33
4.2. Quality Control Maintenance .....	33
4.3. Evaluation and Repair .....	33
<b>5. TROUBLESHOOTING</b> .....	34
<b>6. REVISION SUMMARY</b> .....	37
<b>APPENDIX A</b> — Error Messages	
<b>APPENDIX B</b> — Crimp Quality Monitor Software Upgrade	
<b>APPENDIX C</b> — Printer Hook Up for the Crimp Quality Monitor	
<b>APPENDIX D</b> — Index	

## 1. INTRODUCTION

### 1.1. The Monitor

AMP Crimp Quality Monitor Part No. 856170-1 and adapter kit 856046-1 provide immediate inspection of the crimp height and the work curve of a crimp by analysis of data provided by force and position sensors built into AMP-O-MATIC Stripper-Crimper II machines. The monitor is capable of checking 10,000 crimps per hour. The Crimp Quality Monitor notifies operators with visual and audible cues (flashing light indicators and beeps) when faulty crimps and errors occur.

AMP Crimp Quality Monitor Part No. 856170-1 and adapter kit 856046-1 provide totals of good, bad, and work curve (inspect) failures and the statistics of crimp heights for good and bad crimps on a display or through an RS-232 serial printer port.

Monitor software Rev. 2.02S and later will interface with AMP Data Acquisition System 856679-1 for maintaining this data.

AMP Crimp Quality Monitor Part No. 856170-1 and adapter kit 856046-1 is for use specifically with AMP-O-MATIC Side-Feed Stripper-Crimper Model II Machine Part No. 854040-4.

### 1.2. The Manual

The Crimp Quality Monitor's operation, functions, screens, and keyboard inputs are detailed in this document. Also listed are error messages, their causes, and corrective action. Refer to customer manuals and instructions shipped with the application equipment for machine information.

**NOTE**

*These instructions are to be used in conjunction with AMP documents covering the Side-Feed Stripper-Crimper Model II Machine 854040-4 (409-5807).*

*Pay particular attention to the safety precautions found in customer manual 409-5807.*

Basic operation of the monitor is presented in Section 2, OPERATION. Section 3 contains detailed information on the monitor screens. Section 4 contains maintenance/repair information. Section 5, TROUBLESHOOTING, contains tables with troubleshooting information.

**NOTE**

*Measurements are in metric units [followed by U.S. customary units in brackets].*

Read this manual thoroughly before operating the monitor. The performance of this monitor will depend largely upon the intelligent use of the information contained in this manual.

When reading this manual, pay particular attention to DANGER, CAUTION, and NOTE statements.

**DANGER**

*Denotes an imminent hazard that may result in moderate or severe injury.*

**CAUTION**

*Denotes a condition that may result in product or equipment damage.*

**NOTE**

*Highlights special or important information.*

Refer to Section 6, REVISION SUMMARY, for revision information.

### 1.3. The Crimp Quality Monitor Menu Interface

The operator interfaces with the Crimp Quality Monitor through menus and the keypad. The menus are screen displays with defined input and output fields. Data is entered through the keyboard. Figure 1-1 illustrates the location of the keypad and screen. Figure 1-1 also explains the functions of the keys.

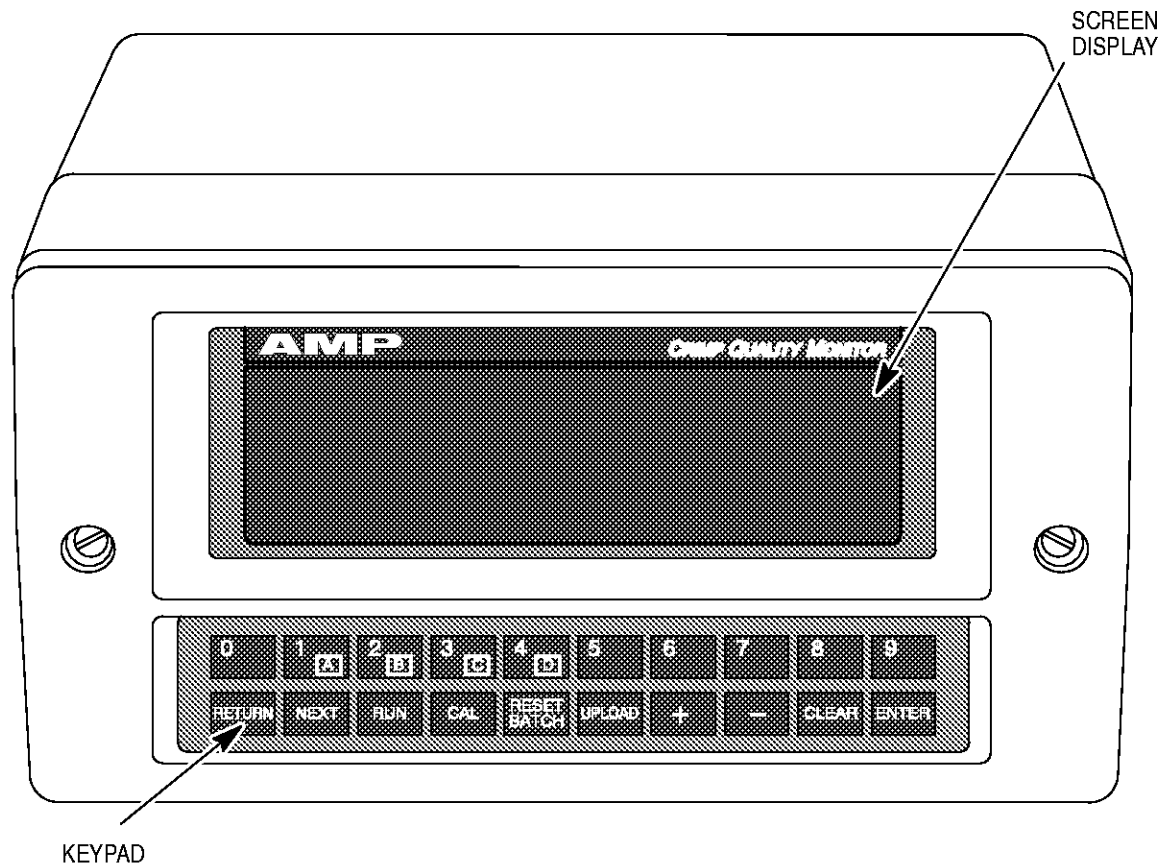

Figure 1-1. Crimp Quality Monitor Interface (Sheet 1 of 2)

200-121E

Input of an invalid key will result in a double beep. Examples of invalid keys are:

- input past end of data field.
- invalid menu selection.
- unexpected key (ie. RUN key while inputting data field).

Errors result in two beeps and an error message displayed on the last line of the display. To acknowledge the error, press RETURN. This clears the error message and places the cursor to the position before the error. Entry of any other key will result in a double beep. Some errors are simply warnings (which the operator can override). These errors result in a double beep and a message on the last two lines of the display. The first line is the error message. The second line is: **“PRESS ENTER TO CONTINUE/RETURN TO EXIT.”**

KEY	ACTION
[A – D]	“HOT KEYS” letters are in the number keys. [A] is in 1; [B] is in 2; [C] in 3; and [D] in 4. Part numbers can be assigned to each key. This allows the current part number height to be changed at the touch of one of these keys. <b>THESE KEYS ARE ACTIVE ONLY IN THE RUN MODE.</b>
NEXT	Used to display pages of data.  If more data exists in the memory than can be displayed on the screen, >> is displayed in the lower right-hand corner of the screen. This data can be displayed by pressing the NEXT key.
RETURN	Returns to the previous menu screen. If an input field is modified and RETURN is pressed, the field is not saved; rather it retains its previous value. If in response to an error message, clears the error display and returns to the position before the error.
CLEAR	Clears the input field and displays underscores.
ENTER	Completes input of a field and saves the value. The cursor is then advanced to the next input field on the current menu. If the field is the last one on the menu, the menu is exited.
RUN	Enters run mode. Run mode displays the x-bar/R-graph and monitors the crimping process.  This is the primary use of the Crimp Quality Monitor.
CAL	Enters the calibration mode to calibrate the monitor.
RESET BATCH	Resets the BATCH COUNT TO “0” (in the RUN mode). It DOES NOT AFFECT THE JOB COUNT.
UPLOAD	Used to upload the current crimp data or part number database through printer serial port 1J4.
[0 – 9]	Numeric keys are used for input in all data fields and to make menu screen selections. If the current menu is a selection menu, pressing a digit causes the selected screen to display. If entering a data field, ENTER must be pressed to save the field’s new value.
+	This key is used to add inspect crimps to Batch and Job Counts in the Run Mode. This key is also used to add crimps (made during Calibration) to the Batch and Job Counts, and scrolls through characters in Job and Operator ID screens.
–	This key is used to view the previous crimp in the Run Mode. This key is also used as a negative sign when entering height-sensor numbers, and as a dash number for part numbers, operator identification numbers (ID), and job identification numbers (ID).

Figure 1-1. Crimp Quality Monitor Interface (Sheet 2 of 2)

Press the ENTER key to override the warning and continue with the requested operation. Press RETURN to return to the previous menu screen. See Figure 1-2 for a listing of monitor screens.

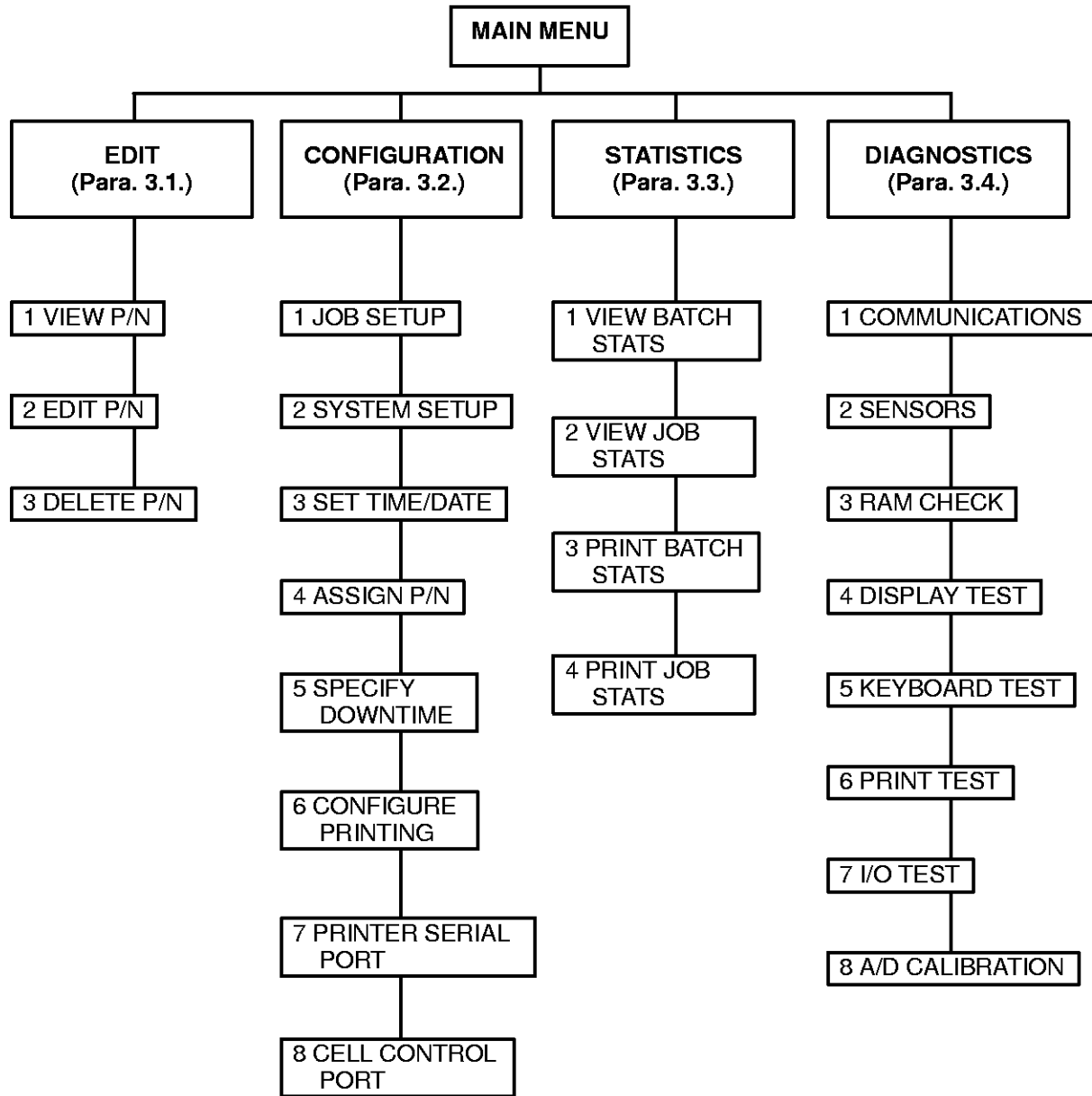

Figure 1-2. Crimp Quality Monitor Screen Tree

## 2. OPERATION

### 2.1. Basic Outline of Operation

This section outlines the sequence of AMP Crimp Quality Monitor operation. For specific information, refer to the appropriate menu heading in Section 3.

After installing the monitor as described in the installation instructions, return to the Main Menu screen by pressing the RETURN key.

**NOTE**

*Pressing the RETURN key returns the operator to the previous screen. Invalid menu selections or input keys will result in a double beep.*

The Main Menu Screen allows the operator to edit the database, configure the monitor, monitor the statistics, or perform diagnostics. See Figure 2-1.

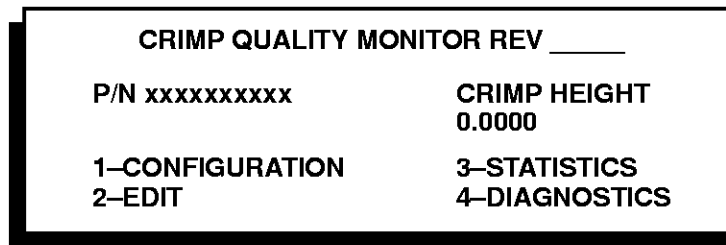

Figure 2-1. Main Menu Screen

**When using the monitor for the first time, it will be necessary to enter information into the monitor's memory using the EDIT menu.**

To operate, continue with the following steps.

**1. Supply the monitor with correct information about the part numbers and applicators**

*(EDIT menu).* The monitor can store information on 100 terminal part numbers for future use. Refer to Section 3.1.

**2. Select the part number to run and enter the height sensor numbers** *(JOB SETUP menu).* Refer to Section 3.2,A. Job Setup also allows the operator to set a Job I/D, Operator I/D, Batch Sizes, and Job Sizes.

**NOTE**

*The CONFIGURATION menu also allows the operator to modify the SYSTEM SETUP which includes the sample size and control count. If interfacing with a printer or Data Acquisition System (DAS), it may be necessary to change parameters in CONFIGURE PRINTING, PRINTER PORT, and CELL CONTROL PORT for proper operation.*

**3. Return to the Main Menu. Calibrate the monitor** *(press the CAL key).* Refer to Section 2-2.

**NOTE**

*CALIBRATION mode and RUN mode should be entered from the Main Menu.*

**4. Return to the Main Menu and press the RUN key** to run the monitor. Refer to Section 2.3.

**5. During a run, it is possible to view or print the statistics of the batch and job in the STATISTICS menu.**

## 2.2. Calibration

The calibration process serves two purposes: 1) to establish an offset factor between actual crimp height and sensor output for the purpose of determining the crimp height; and 2) to establish a work/force curve history for “good” crimps. In the RUN mode, each crimp is compared to this history to determine whether the crimp is “good,” or should be “inspected” for possible unacceptable crimp conditions.

It is possible to calibrate for only the work/force curve history if the comparison between the measured crimp height and the value given by the monitor are in agreement.

**NOTE**

*The operator has the ability to change the range of acceptability for a crimp by increasing or decreasing the work and force coefficients by entering the EDIT P/N screen.*

**NOTE**

*It is necessary to calibrate for crimp height when running a part for the first time. It is recommended that crimp height be calibrated at the beginning of any new job, and after changing or adjusting tooling in the applicator.*

Calibrate as follows:

1. Depress the CAL key from the Main Menu or RUN mode. See Figure 2-2.
2. Determine **calibration count** (yy on the screen), the number of crimps to be used for calibration.
3. Perform a crimp. If the crimp is detected, the calibration count **will** be updated and a prompt **will** indicate that the crimp **was** detected.

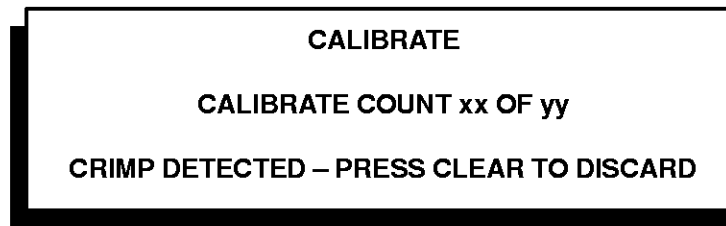

Figure 2-2. CALIBRATE COUNT Screen

**NOTE**

*At least 5 crimps are required (calibration count default). The maximum allowable is 99. For best results, increase the calibration count using the SYSTEM SETUP menu (CONFIGURATION).*

4. Press **ENTER** to accept the last crimp (Figure 2-3), CLEAR to cause the monitor to wait for another crimp, or RETURN to exit the calibrate mode.

The screens shown in Figure 2-4 will display after pressing ENTER.

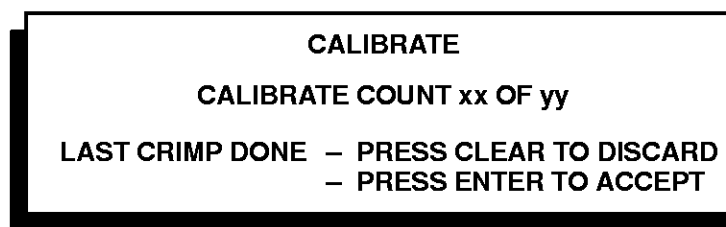

Figure 2-3. CALIBRATE COUNT (LAST CRIMP DONE) Screen

### Error Message

\* DEFECTIVE — NOT ENOUGH VALID POINTS \* — The monitor detected the crimp but was unable to calculate the crimp height accurately. Press RETURN to clear the error and then retry.

**CALIBRATE**

MEASURED CRIMP HEIGHT \_\_\_\_.

CALIBRATE COUNT xx OF yy

CRIMPS COMPLETED – ENTER MEASURED HEIGHT  
PRESS RETURN IF NOT CALIBRATING HEIGHT

**CALIBRATE**

MEASURED CRIMP HEIGHT \_\_\_\_.

CALIBRATE COUNT xx OF yy

PRESS + TO INCLUDE CRIMPS IN BATCH AND JOB  
PRESS RETURN IF NOT INCLUDING CRIMPS

Figure 2-4. CALIBRATE COUNT (MEASURE CRIMP HEIGHT) Screens

5. **Hand measure the crimp and visually inspect to verify that the crimp meets all acceptance criteria.** Clear and repeat crimp or continue with the next sample if acceptable. Continue until screen indicates LAST CRIMP DONE. Press ENTER to accept.

6. If calibrating to update the work curve history **only**, press RETURN. If calibrating for crimp height, enter the hand measured crimp heights of the calibration samples as prompted by the screen. Refer to the Application Specification for the appropriate measurement location.

**NOTE** *The monitor's ability to accurately display crimp height and to identify questionable crimps (inspect) depends on the ability of the operator to make accurate manual measurements and enter only "good" crimps into the calibration.*

**NOTE** *It is recommended that the monitor be calibrated for crimp height after the applicator has been removed and repositioned in the terminating unit, or after any applicator tooling is adjusted.*

**NOTE** *It is recommended that the monitor be calibrated for the work/force curve after changing the work and force coefficients or tolerance, after long periods of downtime, and after adjusting the crimp height.*

7. Press "+" to include crimps in the batch and job counts, or press RETURN if not including crimps. Calibration crimps that are added are not included in the monitor Batch and Job Statistics.



**2.3. Run Mode**

Pressing the RUN key from the Main Menu results in the screen shown in Figure 2-5. The display will show the current part number, crimp height, and tolerance limits for the part number. Also displayed are the batch and job totals thus far, the sample size, and number of crimps thus far in a sample. A bar graph represents the crimp height of each sample. If a sample size greater than one is used, the range of each sample is displayed below the crimp height graph,

**NOTE** *A warning message (“INVALID CALIBRATION FACTOR”) will be displayed prior to entering the RUN Mode if the monitor has not been calibrated.*

Begin production operation.

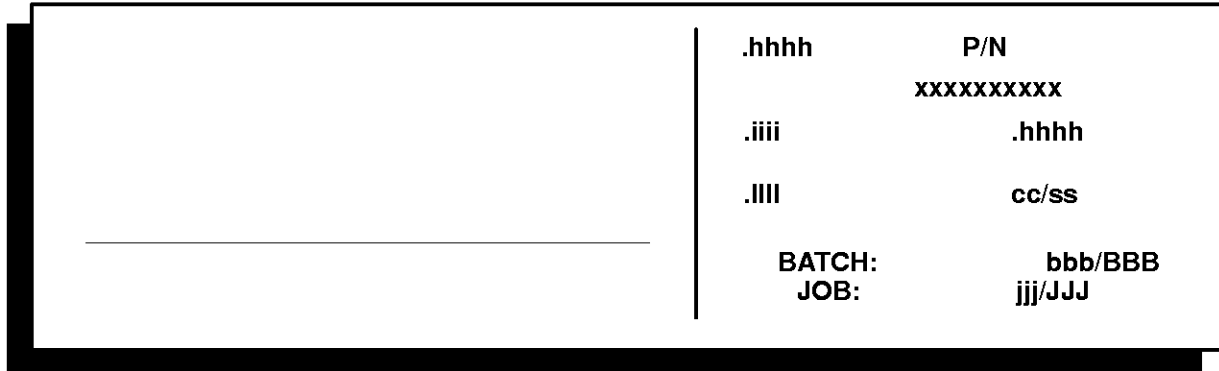

Figure 2-5. RUN MODE Screen

**DATA FIELDS**

xxxxxxxxxx — Current part number.

.hhhh — High tolerance value.

.iii — Ideal (Nominal) crimp height.

.III — Low tolerance value.

.hhhh — Calculated crimp height for the last crimp.

[.hhhh] — Calculated crimp height for the previous crimp.

cc — Number of crimps completed in sample.

ss — Sample size.

BATCH — The number of “good” crimps completed in a batch.

bbb — Batch count.

BBB — Batch size.

JOB — The number of “good” crimps completed in a job.

jjj — Job count.

JJJ — Job size.

**NOTE** *Batch counts and job counts increase:*  
*— with “good” crimps;*  
*— when an inspect crimp is added in the RUN mode;*  
*— when calibration samples are added;*  
*— and when adding crimps in the JOB SETUP Menu.*

## VALID KEYS

- [A-D] ([1-4]) — “Hot keys” to select part numbers assigned to pad letters A – D.  
RETURN — Return to the Main Menu.  
CAL — Enter Calibration mode.  
UPLOAD — Upload crimp data through the printer serial port.

**NOTE** *The **UPLOAD** key must be pressed twice within 0.5 second in order to upload.*

- “-” — Displays the previous crimp height in brackets [.hhhh]  
NEXT — Returns to the current crimp .hhhh.  
“+” — Enables the operator to increase the batch and job counts by 1 if an “INSPECT CRIMP” is determined to be a good crimp.

**NOTE** *Adding “inspect crimps” using the “+” key will not change the Good Counts, Total Counts, or Inspect Counts shown in the monitor statistics (see Section 3.3, STATISTICS.)*

## ERRORS

### **Audible Indicators**

- 3 Short Beeps – Job or batch complete.
- 1 Beep – Crimp height differs from nominal by more than the control limit.
- 2 Beeps – Crimp height and nominal differ by more than the tolerance.
- 1 Sustained Beep and INSPECT message – Work or peak force vary from the mean by more than the associated coefficients allow.

### **Visual (Red/Green Light) Indicators**

- Green Light Only — Indicates no error.
- Red Light Only — Height tolerance error.
- Both Red and Green — INSPECT message was displayed or more consecutive crimps than specified by the control count have fallen outside of the control limit.

## ERROR MESSAGES

- **INVALID CRMP** — INVALID CRIMP indicates that the data from the sensors was inadequate to calculate a crimp height. (The previous crimp height is displayed.)
- **CNTRL LIMIT SET** — CONTROL LIMIT SET indicates that the automatic calculation of the CONTROL LIMIT is complete. This occurs after 30 “good” crimps.
- **BATCH CMPLT** — BATCH COMPLETE displayed along with 3 short beeps indicates that the BATCH COUNT has been reached.
- **JOB COMPLETE** — JOB COMPLETE displayed along with 3 short beeps indicates that the JOB COUNT has been reached.
- **PE** — This message indicates that there is a printer error, and is displayed in the upper right-hand corner when there is a printer buffer overload. The buffer overload may occur when the CTS option is selected and the signal is not provided by the printer. Or the buffer overload may occur if the baud rate is too slow.

Press RETURN to exit the RUN mode.

**NOTE** *A new graph is displayed and the batch count and job count are set to zero each time a part number is selected, the current part number is edited, or a new job is started.*

### 3. CRIMP QUALITY MONITOR MENUS AND SCREENS

#### 3.1. Edit Menu

Selecting Option 2 (EDIT) from the Main Menu results in the menu shown in Figure 3-1.

Select the desired function by pressing the associated key. Enter the password if required. The screen for the selected operation is displayed. Invalid menu selections or input keys will result in a double beep.

**NOTE**

*If the operator modifies the current run part number (selected in CONFIGURATION), then the Crimp Quality Monitor must be recalibrated to yield correct results.*

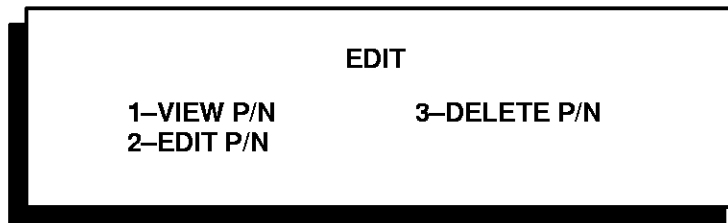

Figure 3-1. EDIT Menu Screen

#### VALID KEYS

- 1 — Enter VIEW PART NUMBER mode (Section 3.1,A)
- 2 — Enter EDIT PART NUMBER mode (Section 3.1,B)
- 3 — Enter DELETE PART NUMBER mode (Section 3.1,C)

RETURN — Return to Main Menu.

#### **A. View Part Number Mode**

Selecting Option 1 from the EDIT menu results in the screen shown in Figure 3-2. Entering a part number in this mode allows the operator to view the part number data fields (see Figure 3-4). CHANGES CANNOT BE MADE TO THE DATA FIELD IN THIS OPTION.

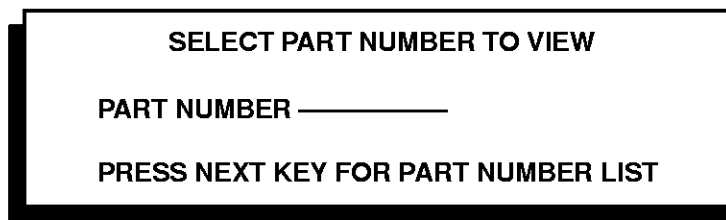

Figure 3-2. VIEW PART NUMBER Screen

## DATA FIELDS

PART NUMBER — Part number to be viewed.

## VALID KEYS

[0 – 9, –] — Enters the part number to be viewed.

ENTER — Completes entry of part number, select part number.

CLEAR — Resets input field to underscores.

RETURN — Returns to EDIT menu.

NEXT — Displays ordered list of part numbers. ( >> *indicates more numbers exist.*)

UPLOAD — Uploads the current part number database through the printer serial port. (Note that the UPLOAD key must be pressed twice within 0.5 seconds.)

## **B. Edit Part Number**

The EDIT function allows the operator to enter or modify the crimp height, tolerance, control limit, work coefficients, and force coefficient associated with the part, and to select the option to have a control limit automatically calculated during the run mode.

Selecting Option 2 (EDIT P/N) from the EDIT menu results in the **ENTER PASSWORD** prompt. Entering the correct password results in the **SELECT PART NUMBER TO EDIT** menu, shown in Figure 3-3.

The **SELECT PART NUMBER TO EDIT** mode allows the operator to select a part number to modify. If the entered part number is not found in the memory, then it is entered.

Select the desired part by:

- a. Entering its part number and pressing ENTER; or
- b. Pressing the NEXT key to select the part number from a list. Select the proper part number by pressing the corresponding number on the screen.

### **NOTE**

*If more part numbers exist in memory than can be displayed by the screen, the >> symbol (located in the lower right-hand corner of the screen) is displayed. Press the NEXT key to see other part numbers. Select the proper number by pressing the corresponding number on the screen.*

The EDIT PART NUMBER DATA FIELDS screen (Figure 3-4) will then be displayed.

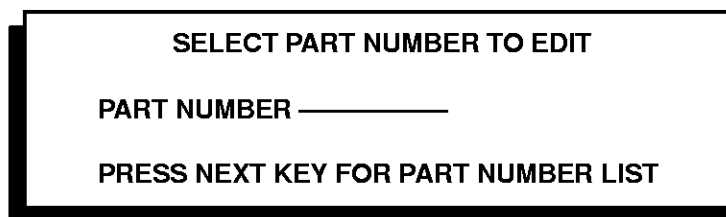

Figure 3-3. *SELECT PART NUMBER TO EDIT* Screen

**DATA FIELDS**

PART NUMBER — Part number to be edited.

**VALID KEYS**

[0 – 9, –] — Enters the part number to be edited.

ENTER — Completes entry of part number, select part number.

CLEAR — Resets input field to underscores.

RETURN — Returns to EDIT menu.

NEXT — Displays ordered list of part numbers. ( >> *indicates more numbers exist.*)

UPLOAD — Uploads the current part number database through the printer serial port. (Note that the UPLOAD key must be pressed **twice** within 0.5 second.)

**ERRORS**

\*\*\* NO PART NUMBERS AVAILABLE \*\*\* – the memory is full. Delete any unused part numbers to make room in the memory. Up to 100 numbers may be stored.

Enter the nominal crimp height, tolerance, control limit, work coefficients, and force coefficient for the part number. These values are used during RUN mode to graph and accept/reject crimps. Enter a control limit and select option to automatically calculate a new control limit (CAL CTRL LIMIT) if desired. Values within the range 0.0001 to 9.9999 are acceptable.

Pushing the ENTER button while editing an existing part number will advance to the next field and retain the existing value.

<b>EDIT PART NUMBER</b>	<b>P/N xxxxxxxxxx</b>
<b>(In./mm)</b>	
<b>CRIMP HEIGHT</b> .____	<b>+WORK COEF 3.000</b>
<b>TOLERANCE</b> 0.____	<b>-WORK COEF 3.000</b>
<b>CONTROL LIMIT</b> 0.____	<b>FORCE COEF 4.000</b> ____
	<b>CAL CTRL LIMIT</b> 0 ____

Figure 3-4. EDIT PART NUMBER DATA FIELDS Screen

**DATA FIELDS**

CRIMP HEIGHT — Nominal crimp height for the part.

TOLERANCE — Tolerance (acceptable +/- height variation from nominal).

CONTROL LIMIT — The **control limit** is the variation from nominal crimp height above which a warning beep is issued (when using a sample size of one).

**NOTE**

When using a sample size greater than 1, the warning beep occurs when the average crimp height of the sample varies from nominal by greater than the assigned Control Limit/square root of "n", where "n" is the sample size. This occurs at the completion of a sample.

CAL CTRL LIMIT — Entering a "1" enables automatic calculation of a control limit equal to 3 times the standard deviation of the next 30 "good" crimp heights of the job. The operator is notified by way of a message in the RUN mode when the control limit is successfully calculated. The new control limit is displayed in the control limit field and the "1" is changed back to "0" in the CAL CTRL LIMIT field.

+/- **WORK COEF** — Represents a multiplier of the standard deviation of the crimp work history used to establish the limits of acceptability. A crimp with a work value outside of the limits as established by the work coefficient will result in an “inspect error.” A suggested starting value is 3.00. A larger number will accept greater variations of work. Refer to troubleshooting section on recommended adjustment procedure.

**FORCE COEF** — Represents a multiplier of the standard deviation of the crimp force history used to establish the limits of acceptability. A crimp with a force value outside of the limits as established by the force coefficient will result in an “inspect error.” A suggested starting value is 4.00. A larger number will accept greater variations of force. Refer to the troubleshooting section (Section 5) for recommended adjustment procedure.

## **ERRORS**

**INPUT VALUE OUT OF RANGE** — Input of 0.0000 is not permitted.

### **C. Delete Part Number Screen**

Selecting Option 3 (DELETE P/N) from the EDIT menu results in the **ENTER PASSWORD** prompt. The operator must enter the password before continuing. Entering the correct password results in the **SELECT PART NUMBER TO DELETE** screen shown in Figure 3-5.

This function allows the operator to select a part number to delete. After selecting a part number the **DELETE PART NUMBER QUERY** screen (Figure 3-6) will be displayed.

Select the desired part by:

- a. Entering its part number and pressing ENTER; or
- b. Pressing the NEXT key to select the part number from a list. Select the proper part number by pressing the corresponding number on the screen.

#### **NOTE**

*If more part numbers exist in memory than can be displayed by the screen, the >> symbol (located in the lower right-hand corner of the screen) is displayed. Press the NEXT key to see other part numbers. Select the proper number by pressing the corresponding number on the screen.*

The **DELETE PART NUMBER** screen (Figure 3-6) is then displayed to ensure that this part number is to be deleted. Press the ENTER key to delete the number.

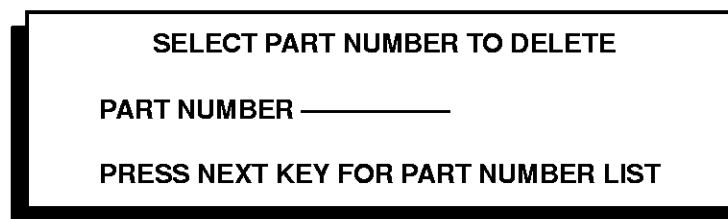

```
SELECT PART NUMBER TO DELETE

PART NUMBER _____

PRESS NEXT KEY FOR PART NUMBER LIST
```

Figure 3-5. *SELECT PART NUMBER TO DELETE* Screen

**DATA FIELDS**

PART NUMBER — Indicates part number to delete.

**VALID KEYS**

[0 – 9, –] — Enters part number to be deleted.

ENTER — Completes entry of part number, select part number.

CLEAR — Resets input field to underscores.

NEXT — Displays ordered list of part numbers. ( >> *indicates more numbers exist.*)

RETURN — Returns to EDIT menu.

UPLOAD — Uploads the current part number database through the printer serial port. (Note that the UPLOAD key must be pressed twice within 0.5 second.)

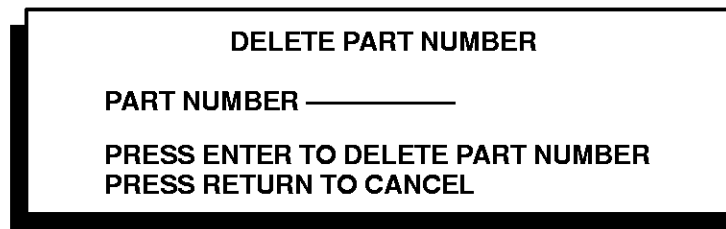

```
DELETE PART NUMBER

PART NUMBER _____

PRESS ENTER TO DELETE PART NUMBER
PRESS RETURN TO CANCEL
```

*Figure 3-6. DELETE PART NUMBER Screen*

**3.2. Configuration Menu**

After the monitor is supplied with the correct information (as described in Section 3.1) it is ready to be configured.

Selecting Option 1 (CONFIGURATION) from the Main Menu results in the menu screen shown in Figure 3-7. This menu allows the operator to perform job setup, as well as modify system parameters, assign part numbers to “hot keys,” and modify the printer and cell control communications parameters.

After the desired function is selected, the screen for the selected operation is displayed.

**Invalid menu selections or input keys will result in a double beep.**

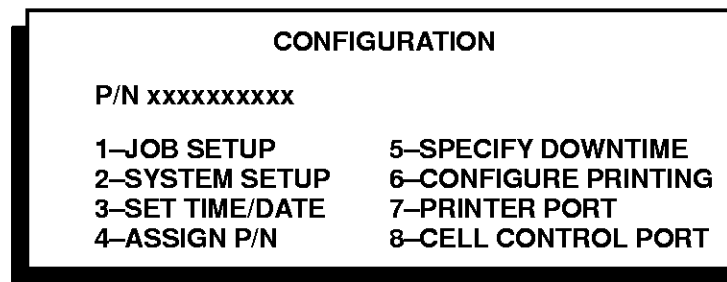

```
CONFIGURATION

P/N xxxxxxxxxxx

1-JOB SETUP           5-SPECIFY DOWNTIME
2-SYSTEM SETUP       6-CONFIGURE PRINTING
3-SET TIME/DATE      7-PRINTER PORT
4-ASSIGN P/N         8-CELL CONTROL PORT
```

*Figure 3-7. CONFIGURATION Menu Screen*

**DATA FIELDS**

P/N — Displays the current part number to run. The number displays as x's if no part number has been selected.

**VALID KEYS**

- 1 — Enters JOB SETUP Menu. See Section 3.2,A.
  - 2 — Enters SYSTEM SETUP Mode. See Section 3.2,B.
  - 3 — Enters SET TIME AND DATE Mode. See Section 3.2,C.
  - 4 — Enters ASSIGN PART NUMBERS TO "HOT KEYS" Mode (Section 3.2,D).
  - 5 — Enters SPECIFY REASON FOR DOWNTIME Menu. (Optional — for use with AMP Manufacturing Cell Control System only.) See Section 3.2,E.
  - 6 — Enters CONFIGURE PRINTING Menu. (Section 3.2,F.)
  - 7 — Enters PRINTER SERIAL PORT Mode. (Section 3.2,G).
  - 8 — Enters CELL CONTROL SERIAL PORT Mode (Section 3.2,H).
- RETURN — Returns to the Main Menu.

**A. Job Setup Menu**

Selecting Option 1 from the CONFIGURATION menu results in the menu shown in Figure 3-8.

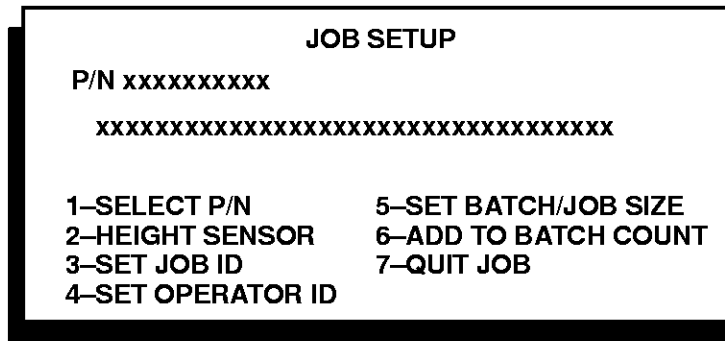

*Figure 3-8. JOB SETUP Menu Screen*

**DATA FIELDS**

P/N – Current part number  
 XXXXXXXXXXXXXXX – Current JOB ID

**VALID KEYS**

[1 – 7] – See the following.  
 RETURN – Returns to the CONFIGURATION menu.



**1 – Enters SELECT P/N TO RUN mode**, allowing the operator to select the current running part number.

<p><b>SELECT PART NUMBER TO RUN</b></p> <p><b>PART NUMBER _____</b></p> <p><b>PRESS NEXT KEY FOR PART NUMBER LIST</b></p>
---

After selecting a part number, the **JOB SETUP** Menu is re-displayed, showing the selected part number as the current part number to run.

If unsure of a part number, press the **NEXT** key to display a list of part numbers. The **SELECT PART NUMBER FROM LIST** menu allows the operator to select from a list of part numbers.

**NOTE** *If more part numbers exist in memory than can be displayed by the screen, the >> symbols (located in the lower right-hand corner of the screen) is displayed. Press the **NEXT** key to see other part numbers. Select the proper number by pressing the corresponding number on the screen.*

**2 – Enters CONFIGURE HEIGHT SENSOR mode**, allowing the operator to enter and modify the height sensor values of the machine. Selecting option 2 results in the **ENTER PASSWORD** prompt.

<b>HEIGHT SENSOR</b>	
<b>ORDER</b>	<b>ORDER</b>
<b>0</b> _____	<b>3</b> _____
<b>1</b> _____	<b>4</b> _____
<b>2</b> _____	<b>5</b> _____

The **HEIGHT SENSOR** screen allows the operator to enter or modify the height sensor numbers associated with the machine. These values are found on an identification tag on the side of the machine, and are also shipped with the machine documentation.

**NOTE** *It is very important that the height sensor numbers be entered correctly.*

**DATA FIELD**

ORDER FIELDS – Height sensor numbers

**VALID KEY**

[1 – 9,-] — Enters height sensor numbers

ENTER — Completes entry/retains the current height sensor numbers.

RETURN — Returns to **JOB SETUP** menu.

CLEAR — Resets input fields to underscores.

**3 – Enters SET JOB ID mode**, allowing the operator to name a job. The JOB ID can be any combination of letters, numbers, and dashes (-) up to 40 characters.

Characters are selected as follows:

- a. Select the active row by pressing the NEXT key until ( >>> <<< ) moves to the desired line.
- b. Find the desired number or letter and press the corresponding number at the top of the appropriate column.
- c. The “ - ” key can also be used.
- d. Press ENTER to enter the JOB ID.

**NOTE**

*If an error is made while entering a JOB ID, repeatedly pressing the + key will move the cursor through the entered characters to allowing correction of the character(s) in error. Pressing the CLEAR key clears the entire data field. The previous JOB ID is displayed in the data field until a new JOB ID is entered. This allows the operator to edit the previous ID by using the + key.*

SET JOB ID											
>>>	0	1	2	3	4	5	6	7	8	9	<<<
	A	B	C	D	E	F	G	H	I	J	
	K	L	M	N	O	P	Q	R	S	T	
	U	V	W	X	Y	Z					

The JOB ID is printed automatically when PRINT HEADER is selected (see CONFIGURE PRINTING) the first time the RUN mode is entered after selecting a new PART NUMBER or JOB ID.

**4 – Enters SET OPERATOR ID mode**, allowing the operator to name or identify the operator. The OPERATOR ID can be any combination of letters, numbers, and dashes (-) up to 10 characters.

SET OPERATOR ID											
-----											
>>>	0	1	2	3	4	5	6	7	8	9	<<<
	A	B	C	D	E	F	G	H	I	J	
	K	L	M	N	O	P	Q	R	S	T	
	U	V	W	X	Y	Z					

Characters are selected as follows:

- a. Select the active row by pressing the NEXT key until ( >>> <<< ) moves to the desired line.
- b. Find the desired number or letter and press the corresponding number at the top of the appropriate column.
- c. The “ - ” key can also be used.
- d. Press ENTER to enter the OPERATOR ID.

**NOTE** *If an error is made while entering the OPERATOR ID, repeatedly pressing the + key will move the cursor through the entered characters to allowing correction of the character(s) in error. Pressing the CLEAR key clears the entire data field. The previous OPERATOR ID is displayed in the data field until a new OPERATOR ID is entered. This allows the operator to edit the previous ID by using the + key.*

The OPERATOR ID is automatically printed when PRINT HEADER is selected (see CONFIGURE PRINTING) the first time the RUN mode is entered after selecting a new PART NUMBER or JOB ID.

**5 – Enters SET BATCH AND JOB SIZES mode**. The BATCH and JOB SIZES represent the target number of “GOOD” crimps necessary to satisfy the production requirement.

SET BATCH AND JOB SIZES	
P/N xxxxxx	
BATCH SIZE _____	JOB SIZE _____

The JOB can consist of several equal sized BATCHES but must be greater than or equal to the BATCH SIZE, or else not specified.

- [0 -9] – Enters the JOB or BATCH SIZE (from 1 to 50,000 Max)
- ENTER – Completes entry of JOB or BATCH SIZE
- CLEAR – Resets input field to underscores
- RETURN – Returns to JOB SETUP Menu

**ERRORS**

- INPUT VALUE IS OUT OF RANGE
- JOB SIZE MAY NOT BE LESS THAN BATCH SIZE

**6 – Enters ADD TO BATCH COUNT mode**, allowing an operator to add samples to the BATCH and JOB counts.

```
ADD TO BATCH COUNT

CURRENT COUNTS: BATCH ____ JOB ____
SIZES: BATCH ____ JOB ____
ADDITION TO COUNT: ____
```

The operator may decide to ADD TO BATCH COUNT if:

1. "INSPECT" crimps meet the criteria of acceptance as determined by manual inspection and it is desired to include these in the batch count.
2. The operator decides to include crimps produced outside of the RUN mode in the batch count.

If the number added causes the count to exceed the batch size, the excess samples are rolled over into the next batch.

If configured to do so (see CONFIGURE PRINTING), the END STATS will be printed when the batch and job counts are rolled over. The printout for END STATS will contain the batch or job count, as well as the Crimp Quality Monitor statistics. **The TOTAL displayed are only those crimps monitored by the Crimp Quality Monitor. For this reason the quality of the NUMBER ADDED is the responsibility of the operator.**

It is also possible to increase the NUMBER ADDED by accepting the CALIBRATION samples into the batch count. Press the "+" key to include crimps into the batch and job count (in the CALIBRATION mode).

It is also possible to include the current "INSPECT" crimp into the batch count in the RUN mode. Press the "+" key if manual inspection has confirmed that the crimp meets all criteria of acceptance.

**7 – Enters the QUIT JOB mode.** Pressing the ENTER key quits the current JOB and removes the JOB ID, BATCH SIZE, and JOB SIZE from the Crimp Quality Monitor's memory.

```
QUIT JOB?

CURRENT JOB ID
JOB SIZE xxxx JOB COUNT xxxx
PRESS ENTER TO QUIT JOB
PRESS RETURN TO CANCEL
```

## B. System Setup Menu

Selecting Option 2 from the CONFIGURATION menu results in the SYSTEM SETUP menu shown in Figure 3-9.

This menu allows the operator to modify the current system configuration of run-time parameters.

Since the system setup is protected, you are required to enter the SYSTEM SETUP password in order to edit the system configuration parameters. The CONFIGURATION menu is redisplayed after all input fields have been entered, or after entry of RETURN.

### NOTE

*Be certain to record the SYSTEM SETUP password and store it in a safe place.*

SYSTEM SETUP	
PASSWORD _____	SAMPLE SIZE 0
CALIB COUNT 5	PASSWORD SET _____
ENG (0)/MET (1) 0	

Figure 3-9. SYSTEM SETUP Menu Screen

### DATA FIELDS

**PASSWORD** — Current SYSTEM SETUP password. The operator must enter the correct password in order to modify the setup data. Initially the password is simply the ENTER key. Input displays as '\*' characters.

**CALIB COUNT** — Number of crimps to perform during CALIBRATION. Range 5-99, the minimum value is five.

**ENG(0)/MET(1)** — Changes the display from English units to Metric Units. A value of '0' will display in inches. A value of '1' will display in millimeters.

**SAMPLE SIZE** — The number of crimps in a sample. Each x-bar/R graph column represents the average of the crimps in that sample.

**PASSWORD SET** — Allows the operator to modify the system setup password. Displays '\*' characters as new password is entered.

### VALID KEYS

[0 - 9] — Input data in input fields.

ENTER — Completes entry of data field, and goes to next data field. Pressing ENTER on the last field, returns to CONFIGURATION menu.

CLEAR — Resets input field to underscores.

RETURN — Returns to CONFIGURATION menu. If some of the data fields have been modified, they remain modified.

**ERRORS**

“INPUT VALUE IS OUT OF RANGE” – Attempted to input a value outside of the acceptable range.

“PASSWORD DOES NOT MATCH” – The input password does not match the system setup password. Try again. If after five tries the correct password has not been entered, the CONFIGURATION menu is displayed and the system setup data is not modified.

**C. Set Time and Date Screen**

Entering option 3 from the CONFIGURATION menu results in the screen shown in Figure 3-10.

This function allows the operator to identify the manufacturing date and time of a job by setting the correct date/time and selecting “PRINT HEADER” (see CONFIGURE PRINTING). The date/time is printed with the header automatically upon entering the RUN mode for the first time after selecting a new part number or job ID.

SET TIME AND DATE	
MONTH __	AM(0) PM(1) __
DAY __	HOURS __
YEAR __	MINUTES __
	SECONDS __

*Figure 3-10. SET TIME AND DATE Screen*

**VALID KEYS**

[0 – 9] — Input data in input fields.

ENTER — Completes entry of data field, and goes to next data field. Pressing ENTER on the last field, returns to CONFIGURATION menu.

CLEAR — Resets input field to underscores.

RETURN — Returns to CONFIGURATION menu. If some of the data fields have been modified, they remain modified.

**ERRORS**

INPUT VALUE OUT OF RANGE

## D. Assign Part Numbers to 'HOT KEYS'

Selecting Option 4 (ASSIGN P/Ns) from the CONFIGURATION menu results in the screen shown in Figure 3-11.

Assigning part numbers to these keys allows the operator to change the current part number in the RUN mode without going into the CONFIGURATION menu.

Enter a valid part number for each 'HOT KEY' to be used. If a 'HOT KEY' is unused, press ENTER. Pressing a 'HOT KEY' in RUN Mode will select the associated part number.

Press the NEXT key to select a part number from a list.

### NOTE

If more part numbers exist in memory than can be displayed by the screen, the >> symbol (located in the lower right-hand corner of the screen) is displayed. Press the NEXT key to see other part numbers. Select the proper number by pressing the corresponding number on the screen.

**ASSIGN PART NUMBERS TO KEYS**

A: _____	C: _____
B: _____	D: _____

**PRESS NEXT KEY FOR P/N LIST**

Figure 3-11. ASSIGN PART NUMBERS TO KEYS Screen

### VALID KEYS

[0 - 9] — Inputs data in input fields.

ENTER — Completes entry of data field, and goes to next data field. Pressing ENTER on the last field returns to CONFIGURATION menu.

CLEAR — Resets input field to underscores.

RETURN — Returns to CONFIGURATION menu. If the data fields have been modified, they remain modified.

NEXT — Display ordered list of part numbers. (>> indicates more numbers exist.)

### ERRORS

PART NUMBER NOT FOUND IN DATA BASE — The part number is unknown to the Crimp Quality Monitor. Select a known part.

### E. Specify (Reason for) Downtime Menu (For AMP Manufacturing Cell Control System Use Only)

Selecting Option 5 from the CONFIGURATION menu results in the SPECIFY REASON FOR DOWNTIME menu screen, shown in Figure 3-12.

Although this screen may appear, it will not function since the Stripper-Crimper II version of the Crimp Quality Monitor is not compatible with the AMP Cell Control System.

Press RETURN to return to the CONFIGURATION menu.

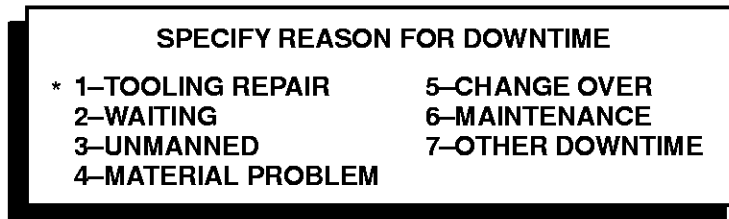

Figure 3-12. SPECIFY REASON FOR DOWNTIME Menu Screen

### F. Configure Printer Mode

Selecting Option 6 from the CONFIGURATION menu results in the CONFIGURE PRINTER screen, shown in Figure 3-13.

The CONFIGURE PRINTER screen allows the operator to modify the current configuration in which the Crimp Quality Monitor prints to a serial printer, and to select various printing options.

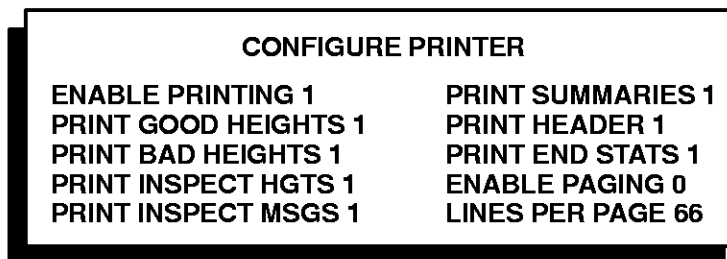

Figure 3-13. CONFIGURE PRINTER Screen

#### DATA FIELDS

ENABLE PRINTING — Determines whether printing is enabled (1 – enabled, 0 – disabled.).

#### **NOTE**

*If the option in the Printer Serial Port screen to “USE FOR CELL CONTROL” is enabled, this option will be automatically disabled.*

PRINT GOOD HEIGHTS — Determines whether good heights are printed. (1 – enabled; 0 – disabled.)

PRINT BAD HEIGHTS — Determines whether bad heights are printed. (1 – enabled; 0 – disabled.) An asterisk (\*) on the printout indicates a bad height.

PRINT INSPECT HGTS — Determines whether heights of crimps to be inspected are printed. (1 – enabled; 0 – disabled.)



**PRINT INSPECT MSGS** — Determines whether an INSPECT message is printed when a crimp to be inspected is detected. (1 – enabled; 0 – disabled.)

**PRINT SUMMARIES** — Determines whether the number of consecutive GOOD, BAD, and INSPECT crimps is printed. If good, bad, or inspect crimp heights are enabled, the summaries for the corresponding crimp type are disabled.

**PRINT HEADER** — Determines whether a header is printed. The header contains the date and time, operator id, job id, part number and part number information and monitor cell control address. If enabled (1), the header will be printed the first time the RUN mode is entered after selecting a new part number, or job id. If ENABLE PAGING is enabled (1), a form feed will be sent before the header.

**PRINT END STATS** — Determines whether batch and job statistics are printed upon completion of a batch and job. The printout contains the date and time, operator id, part number, batch or job count, the number added, and the Crimp Quality Monitor STATISTICS. The monitor statistics contain the TOTAL, GOOD, BAD, and INSPECT counts, and the mean and standard deviation of the GOOD and BAD crimp heights and the PERCENT GOOD of the TOTAL.

**ENABLE PAGING** — Determines whether a form feed should be sent at the bottom of the page (1 – enabled; 0 – disabled). If paging is enabled, enter the number of lines per page desired in the last field.

**LINES PER PAGE** — Determines the number of lines per page if paging is enabled.

**NOTE** *The lines range between 1 and 99. The default is 66.*

## **ERRORS**

**INPUT VALUE IS OUT OF RANGE** — Attempted to input a value which is out of range.

**CANNOT PRINT IF USED FOR CELL CONTROL** — Attempted to enable printing with “USE FOR CELL CONTROL” selected in the PRINTER SERIAL PORT Mode.

## **G. Printer Serial Port Screen**

Selecting Option 7 from the CONFIGURATION menu results in the PRINTER SERIAL PORT screen, shown in Figure 3-14. This screen allows the operator to modify the current configuration of the printer serial port.

Enter the Crimp Quality Monitor password. Then enter the parameters for the printer serial port.

<b>PRINTER SERIAL PORT</b>	
<b>PASSWORD</b> _____	<b>PARITY ENABLE</b> 0
<b>BAUD RATE</b> 4800	<b>EVEN PARITY</b> 1
<b>STOP BITS</b> 10	<b>CTS ENABLE</b> 0
<b>CHAR LENGTH</b> 8	<b>USE FOR CELL CONTROL</b> 0

*Figure 3-14. PRINTER SERIAL PORT Screen*

**DATA FIELDS**

**PASSWORD** — Current SYSTEM SETUP password. The operator must enter the correct password in order to modify the port configuration. Input displays as "\*" characters.

**BAUD RATE** — Baud rate of printer serial port (600, 1200, 2400, 4800, or 9600).

**STOP BITS** — Stop bits for printer serial port (10 = 1.0, 15 = 1.5, or 20 = 2.0).

**CHAR LENGTH** — Character length of printer serial port (5, 6, 7, or 8).

**PARITY ENABLE** — Whether printer serial port parity is enabled (1 = enabled; 0 = disabled).

**EVEN PARITY** — Printer serial port parity if enabled (1 = EVEN, 0 = ODD).

**CTS ENABLE (Clear to Send)** — Select by choosing "1" if the printer you are using is equipped with this feature. This feature will prevent overloading the printer buffer. (1 = enabled; 0 = disabled.)

**USE FOR CELL CONTROL** — Determines whether the printer port is used for the AMP Data Acquisition System (DAS) (1 = enabled; 0 = disabled).

**VALID KEYS**

[0 - 9] — Enter data into input fields.

**ENTER** — Completes entry of data field, and goes to next data field. Pressing ENTER on the last field, returns to CONFIGURATION menu.

**CLEAR** — Resets input field to underscores.

**RETURN** — Returns to CONFIGURATION menu.

**ERRORS**

**INPUT VALUE IS OUT OF RANGE** – Attempted to input a value which is out of range.

**INVALID BAUD RATE SPECIFIED** – An invalid baud rate was entered. Enter a valid baud rate.

**INVALID NUMBER OF STOP BITS SPECIFIED** – An invalid number of stop bits was entered. Enter a valid number.

**PASSWORD DOES NOT MATCH** – The input password does not match the SYSTEM SETUP password. Try again. If after five tries the correct password has not been entered, the CONFIGURATION menu is displayed and the SYSTEM SETUP data is not modified.

**H. Cell Control Serial Port Screen**

Selecting Option 8 from the CONFIGURATION menu results in the CELL CONTROL SERIAL PORT Menu screen, shown in Figure 3-15.

First enter the password. Then enter the parameters for the cell control serial port.

<b>CELL CONTROL SERIAL PORT</b>	
<b>PASSWORD</b> _____	<b>PARITY ENABLE</b> 0
<b>BAUD RATE</b> 9600	<b>EVEN PARITY</b> 1
<b>STOP BITS</b> 10	<b>CELL ADDRESS</b> 1
<b>CHAR LENGTH</b> 8	

Figure 3-15. CELL CONTROL SERIAL PORT Screen

**DATA FIELDS**

**PASSWORD** — Current system setup password. The operator must enter the correct password in order to modify the port configuration. Input displays as "\*" characters.

**BAUD RATE** — Baud rate of cell control serial port (600, 1200, 2400, 4800, or 9600).

**STOP BITS** — Stop bits for cell control serial port (10 = 1.0, 15 = 1.5, or 20 = 2.0).

**CHAR LENGTH** — Character length of cell control serial port (5, 6, 7, or 8).

**PARITY ENABLE** — Whether cell control serial port parity is enabled (1 = enabled, 0 = disabled).

**EVEN PARITY** — Cell control serial port parity if enabled (1 = EVEN, 0 = ODD).

**CELL ADDRESS** — Sets the monitor address for the AMP Data Acquisition System.

**VALID KEYS**

[0 - 9] — Input data in input fields.

**ENTER** — Complete entry of data field, and go to next data field. On last field, return to **CONFIGURATION** menu.

**CLEAR** — Reset input field to underscores.

**RETURN** — Return to **CONFIGURATION** menu.

**ERRORS**

**INPUT VALUE IS OUT OF RANGE** — Attempted to input a value which is out of range.

**INVALID BAUD RATE SPECIFIED** — An invalid baud rate was entered. Enter a valid baud rate.

**INVALID NUMBER OF STOP BITS SPECIFIED** — An invalid number of stop bits was entered. Enter a valid number.

**PASSWORD DOES NOT MATCH** — The input password does not match the system setup password. Try again. If after five tries the correct password has not been entered, the **CONFIGURATION** menu is displayed and the system setup data is not modified.

**3.3. Statistics Menu**

Selecting option 3 from the Main Menu results in the **STATISTICS** menu, shown in Figure 3-16. This menu allows the operator to view and print statistics.

```

          STATISTICS
        P/N xxxxxxxx
1 — VIEW BATCH STATS   3 — PRINT BATCH STATS
2 — VIEW JOB STATS     4 — PRINT JOB STATS

```

Figure 3-16. *STATISTICS Menu Screen*

Enter a "1" to enter the VIEW BATCH STATISTICS menu (Figure 3-17), which displays the statistics for the current batch on the screen. Enter a "3" to instruct a printer to print the same information which is displayed by the VIEW BATCH STATISTICS Screen. Enter the RETURN key to return to the Main Menu.

VIEW STATISTICS				
P/N xxxxxxxxx				
COUNTS		MEAN	(IN/MM)	STD DV
TOTAL:	0	GOOD:	0.0000	0.0000
GOOD:	0	BAD:	0.0000	0.0000
BAD:	0			
INSPECT:	0	PERCENT GOOD	100.00	

Figure 3-17. VIEW STATISTICS Menu Screen

The "view" and "print" features for JOB STATISTICS operate identically to those for the BATCH STATISTICS. Use the 2 and 4 keys for JOB STATISTICS.

#### DATA FIELDS

TOTAL COUNT — Total number of "good," "bad," and "inspect" crimps in the current batch or job.

GOOD COUNT — Number of "good" crimps in the current batch or job.

#### **NOTE**

*The GOOD COUNT does not include calibration crimps which may have been included in the batch and job, inspect crimps which may have been added to the batch and job count in the RUN Mode, or crimps which are added to the batch and job using the ADD TO BATCH COUNT screen.*

BAD COUNT — Number of "bad" crimps in the current batch or job.

PERCENT GOOD — Percent of "good" crimps of the total count in the current batch or job.

INSPECT COUNT — Number of crimps causing INSPECT message in the current batch or job.

GOOD MEAN — Mean height of "good" crimps in the current batch or job.

GOOD STD DV — Standard deviation of "good" crimps in the current batch or job.

BAD MEAN — Mean height of "bad" crimps in the current batch or job.

BAD STD DV — Standard deviation of "bad" crimps in the current batch or job.

#### VALID KEYS

RETURN — Returns to STATISTICS menu. Enter the RETURN key to return to the STATISTICS menu after viewing the batch statistics. All other input is invalid.

### 3.4. Diagnostics Menu

Selecting Option 4 from the Main Menu results in the ENTER PASSWORD prompt. The operator must enter the correct password before continuing. Entering the correct password results in the DIAGNOSTICS Menu screen, shown in Figure 3-18. Diagnostics mode allows the operator to perform diagnostics of the Crimp Quality Monitor.

Select the desired function by pressing the associated key. The menu for the selected operation will display. Invalid menu selections or input keys will result in a double beep.

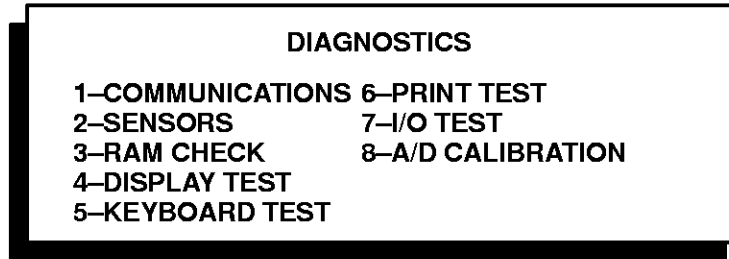

Figure 3-18. DIAGNOSTICS Menu Screen

#### VALID KEYS

- 1 — Enters COMMUNICATIONS DIAGNOSTICS menu (Section 3.4,A).
- 2 — Enters SENSOR DIAGNOSTICS menu (Section 3.4,B).
- 3 — Enters RAM CHECK DIAGNOSTICS menu (Section 3.4,C).
- 4 — Enters DISPLAY DIAGNOSTICS menu (Section 3.4,D).
- 5 — Enters KEYBOARD DIAGNOSTICS menu (Section 3.4,E).
- 6 — Enters PRINT TEST DIAGNOSTICS menu (Section 3.4,F).
- 7 — Enters I/O TEST DIAGNOSTICS menu (Section 3.4,G).
- 8 — Enters A/D CALIBRATION menu (Section 3.4,H).
- RETURN — Returns to Main Menu.

#### A. Communications Diagnostics Screen

Selecting Option 1 from the DIAGNOSTICS menu screen results in the COMMUNICATIONS DIAGNOSTICS screen shown in Figure 3-19. This screen tests the communications capabilities of the Crimp Quality Monitor when the monitor is used with the AMP Data Acquisition System. It displays all characters received over the cell control port (or printer port if selected for cell control).

The monitor does not transmit data during this mode.

Press RETURN to return to the DIAGNOSTICS menu and resume communication.

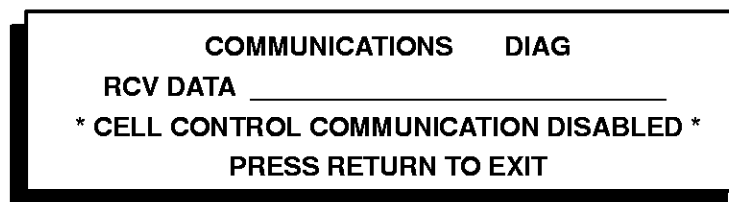

Figure 3-19. COMMUNICATIONS DIAGNOSTICS Menu Screen

#### DATA FIELDS

RCV MSG — Message received over cell control port.

#### VALID KEYS

RETURN — Returns to DIAGNOSTICS menu.

## B. Sensors Diagnostics Screen

Selecting option 2 from the DIAGNOSTICS menu results in the SENSORS DIAGNOSTICS screen, shown in Figure 3-20. This screen displays the current A/D values for the height and force sensors. Refer to SYSTEM SENSOR CHECK, Page v, for proper A/D values.

**NOTE** During sensor diagnostics, the Crimp Quality Monitor does not check for actual crimps.

Every 250 ms the display is updated to reflect the current height and force sensor readings. The display is useful to diagnose the sensors and cables.

Press the RETURN key to return to the Diagnostics menu.

**NOTE** The sensor readings will vary slightly due to electrical noise.

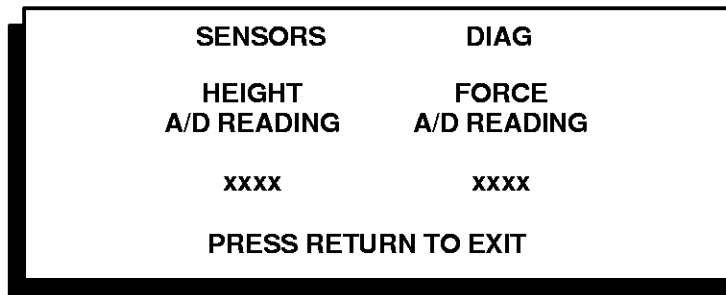

Figure 3-20. SENSORS DIAGNOSTICS Screen

### DATA FIELDS

HEIGHT READING — Current height sensor reading.

FORCE READING — Current force sensor reading.

### VALID KEYS

RETURN — Returns to DIAGNOSTICS menu.

## C. Ram Check Diagnostics Screen

Selecting Option 3 (RAM CHECK) from the DIAGNOSTICS menu results in the screen shown in Figure 3-21.

This screen allows the operator to perform a check of the Random Access Memory (RAM) in the Crimp Quality Monitor.

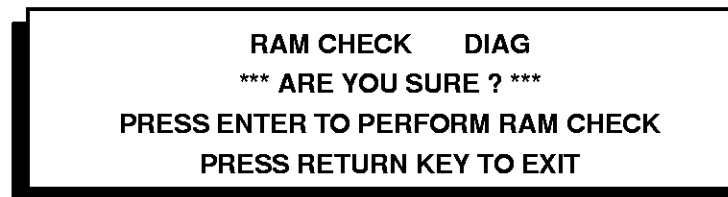

Figure 3-21. RAM CHECK Screen

Pressing ENTER will cause the system RAM to be read/write tested. If all of the RAM is tested successfully, the message "\*\*\* PASSED \*\*\*" is displayed. If the test fails, "\*\*\* FAILURE AT OFFSET XXXXXX \*\*\*" is displayed. "XXXXXX" indicates the first RAM location which failed. Pressing RETURN returns to the DIAGNOSTICS menu screen.

#### D. Display Test Diagnostics Screen

Selecting Option 4 (DISPLAY) from the DIAGNOSTICS menu fills the screen by repeatedly displaying the entire character set of the monitor display.

Press the RETURN key to return to the DIAGNOSTICS menu.

#### E. Keyboard Test Diagnostics Screen

Selecting option 5 from the DIAGNOSTICS menu results in the KEYBOARD TEST DIAGNOSTICS screen, shown in Figure 3-22. This screen allows the operator to interactively test the keys on the keypad.

Press any key to display its key number and legend. All keys are valid as input. Pressing RETURN causes the prompt "PRESS RETURN KEY AGAIN TO EXIT."

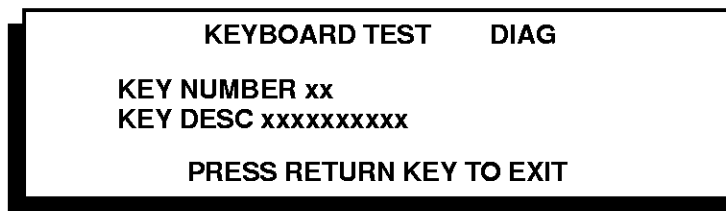

Figure 3-22. KEYBOARD TEST DIAGNOSTICS Screen

#### F. Print Test Diagnostics Screen

Selecting option 6 from the DIAGNOSTICS menu results in PRINT TEST DIAGNOSTICS function. This function allows the operator to check the serial printer communications.

The printer test—prints multiple character sets by way of the serial printer port. When the test is complete, the DIAGNOSTICS menu is displayed. See Figure 3-23.



Figure 3-23. PRINT TEST DIAGNOSTICS Screen

#### ERROR

**PRINTER TIME OUT OCCURRED** — The monitor did not receive a signal on the CTS line (if the CTS option is enabled).

## G. I/O Test Diagnostics Screen

Selecting option 7 from the DIAGNOSTICS menu results in the I/O TEST DIAGNOSTIC screen, shown in Figure 3-24. This test allows the operator to check the inputs and outputs and the solid state relays.

The fields continuously reflect the status of:

- **the four inputs;**
- **the four outputs;** and
- **the solid state relays.**

### OUTPUTS

- 1 – Green light;
- 2 – Red light;

### SS RELAYS (Solid State Relays)

- 5 – SSR1
- 6 – SSR2

Pressing a number key will cause the status of the associated output or solid state relay to toggle. Pressing RETURN will end the I/O test and return to the DIAGNOSTICS menu.

I/O TEST		DIAG
<b>INPUTS</b>	<b>OUTPUTS</b>	<b>SS RELAYS</b>
1 OFF	1 OFF	5 OFF
2 OFF	2 OFF	6 OFF
3 OFF	3 OFF	
4 OFF	4 OFF	
<b>HIT NUMERIC KEY TO TOGGLE OUTPUT OR SSR</b>		

Figure 3-24. I/O TEST DIAGNOSTICS Menu Screen

### **CAUTION**

*Be sure all outputs and relays are turned OFF before leaving the Diagnostics mode. Outputs left ON will remain ON if not turned off.*

## H. A/D Calibration Screen

Selecting option 8 from the DIAGNOSTICS menu results in the A/D CALIBRATION Screen, shown in Figure 3-25.

A/D calibration is used internally to compensate for the monitor and system variance from nominal values.



**CAUTION** THIS FUNCTION MUST BE USED ONLY BY TRAINED PERSONNEL.

LOW VOLTAGE on the screen is read from a digital voltmeter attached to the A/D calibration switch and entered.

HIGH VOLTAGE is read from the digital voltmeter with the switch in the high voltage position and entered.

#### **VALID KEYS**

CLEAR — Resets input field to underscores.

RETURN — Returns to the DIAGNOSTICS menu.

[0 – 9] — Enters data into input fields.

ENTER — Completes entry of input into data fields.

#### **ERROR MESSAGE**

“INPUT VALUE OF 0.0000 IS INVALID.”

Refer to Section 5, TROUBLESHOOTING.

<b>A/D CALIBRATION</b>	<b>DIAG</b>
<b>LOW VOLTAGE</b> _._____	
<b>HIGH VOLTAGE</b> _._____	

*Figure 3-25. A/D CALIBRATION Menu Screen*

#### 4. CRIMP QUALITY MONITOR MAINTENANCE/REPAIR

The following procedures have been established to assure the quality and reliability of the Crimp Quality Monitor. The monitor should be checked daily, and a more detailed inspection should be performed by your quality control group on a regular basis.

##### 4.1. Daily Maintenance

Each operator should be aware of, and responsible for, the following steps of maintenance:

1. Remove dust, moisture, and other contaminants with a clean brush, or soft, lint-free cloth. Do NOT use objects that could damage the monitor.
2. Make sure all components are in place and properly secured.

##### 4.2. Quality Control Maintenance

Regular inspections should be performed by your quality control personnel. A record of quality control inspections should remain with the personnel responsible for the monitor. We recommend one inspection a month; however, operator skill, amount of use, ambient working conditions, and your company's established standards are all factors in establishing frequency of inspections.

1. Remove any accumulated film with a suitable cleaning agent that will NOT affect plastic material.
2. Make sure all components are in place and are properly secured.
3. Check for chipped, cracked, worn, or broken areas.
4. Complete diagnostics as described in Section 3.4.

##### 4.3. Evaluation and Repair

Crimp Quality Monitors can be returned to AMP Incorporated for evaluation and repair. Call the Tooling Assistance Center 1-800-722-1111 for instructions.

Crimp Quality Monitors can be ordered through your AMP representative, or call 1-800-526-5142, or send a facsimile of your purchase order to 1-717-986-7605, or write to:

CUSTOMER SERVICE (38-35)  
AMP INCORPORATED  
P.O. BOX 3608  
HARRISBURG, PA 17105-3608

**5. TROUBLESHOOTING THE CRIMP QUALITY MONITOR**

PROBLEM	ACTION
Screen is blank when the machine power is "ON."	<p>Check for flashing HEARTBEAT LED.</p> <p><b><u>Heartbeat LED NOT Flashing</u></b></p> <ul style="list-style-type: none"> <li>-Check AC power cord.</li> <li>-Check fuse in the power entry module.</li> <li>-If this problem occurred immediately after a software change, verify correct location and proper mating of the proms to their sockets.</li> <li>-Check fuse in the power supply board.</li> <li>-Check cables from the power supply board to the processor board.</li> <li>-Check for +5Vdc on the power supply board. J2 Pin 1=+5Vdc. Pin 4=ground.</li> </ul> <p><b><u>Heartbeat LED Flashing</u></b></p> <ul style="list-style-type: none"> <li>-Check connectors/cables from the Processor Board J6 to the Display Interface Board J1.</li> </ul>
Display shows unwanted characters.	<p>Perform RAM Check Diagnostic.</p> <p><b><u>Diagnostic Failed</u></b></p> <ul style="list-style-type: none"> <li>-Perform the test again. If failure is repeated report this to AMP Incorporated immediately!</li> </ul> <p><b><u>Diagnostic Passed</u></b></p> <ul style="list-style-type: none"> <li>-Initialize RAM.               <ol style="list-style-type: none"> <li>1. Turn power OFF.</li> <li>2. Insert paper between the battery and its retaining arm on the processor board.</li> <li>3. Remove the paper and turn power ON.</li> <li>4. Press <b>ENTER</b> to re-initialize to defaults.</li> </ol> </li> </ul> <p><b>NOTE:</b> <i>All part numbers, part histories, A/D calibration values, and any configuration or setup values that were changed from default values will be lost and must be re-entered.</i></p>
The display is lit but no characters are on the display.	<p>Check adjustment of the display contrast control through the hole on the bottom right side of the monitor.</p>
The display fades when a printer is connected to the RS 232 port.	<p>Report this problem to AMP Incorporated.</p>
Crimp height value displayed on the monitor is erratic while the actual measured value remains consistent.	<p>Check the condition of the TEFLON● gaskets and reduce crimper bolt torque as described in 2.E, on the following page.</p>
Crimp height value displayed is consistent but is different from the actual measured value.	<ol style="list-style-type: none"> <li>1. Perform a crimp height calibration.</li> <li>2. Perform A/D Calibration as described for "DEFECTIVE – NOT ENOUGH VALID POINTS" error message.</li> </ol>
The crimp height value displayed is unchanging for all crimps or not responsive to changes of the crimp disc on the applicator (Pads A through D) or the terminator's adjustable base plate.	<p>Perform A/D Calibration as described for "DEFECTIVE – NOT ENOUGH VALID POINTS" error message.</p>

● Trademark of E.I. DuPont de Nemours

PROBLEM	ACTION
<p><b>“DEFECTIVE – NOT ENOUGH VALID POINT”</b> Error Message. or <b>“INVALID CRIMP”</b></p> <p><b>NOTE:</b> <i>Verify correct numerical values for the height sensor and part number being used before continuing!!</i></p>	<ol style="list-style-type: none"> <li>1. Check (and adjust if necessary) the system sensor as described in the RECEIVING/INSPECTION/INSTALLATION section.</li> <li>2. Perform an A/D calibration.               <ol style="list-style-type: none"> <li>A. <b>TURN POWER OFF.</b></li> <li>B. Remove the sensor cable from J3 on the monitor.</li> <li>C. Connect the A/D calibration switch supplied with the monitor to J3.</li> <li>D. Connect a digital volt meter to the red (+) and black (-) leads of the switch. Set meter scale on <b>DC</b> volts.</li> <li>E. <b>TURN POWER ON</b>, select A/D Calibration from the Diagnostics menu (Section 3.4,H).</li> <li>F. Toggle the A/D calibration switch so the meter reads approximately 1 volt dc. Enter the exact reading shown on the meter into the Crimp Quality Monitor and press ENTER. (Be sure to enter the leading zero if the reading is less than 1 volt).</li> <li>G. Toggle the A/D calibration switch. The meter should now read approximately 9 volts. Enter the exact reading shown on the meter into the Crimp Quality Monitor and press ENTER.</li> <li>H. Press RETURN twice to exit the CALIBRATION screen and return to the Main menu.</li> <li>I. <b>TURN POWER OFF</b>, remove the calibration switch, re-connect sensor cable to J3.</li> <li>J. <b>TURN POWER ON.</b> Calibration is now complete.</li> </ol> </li> </ol>

PROBLEM	ACTION
<p>Green or Red LEDs do not light on the remote status box.</p> <p>LED P/N 986535-1 = RED LED P/N 986535-2 = GREEN</p>	<p>1. <b>BOTH</b> LEDs do not light.</p> <p>A. Check cable connection at 1J8 on the monitor.</p> <p>B. Select the I/O Test Diagnostics. Press keys 1 and 2. Do output LEDs 1 and 2 light on the rear of the monitor?</p> <p><b>IF YES-TURN POWER OFF:</b></p> <ul style="list-style-type: none"> <li>-Check 5A fuse F1 on the right rear side of the processor board.</li> <li>-Check for proper connection of cable from J9 on the processor board to J3 on the power supply board.</li> <li>-Remove four sheet metal screws from the remote indicator box assembly and remove the rear/side cover.</li> <li>-<b>TURN POWER ON</b> and select I/O Test Diagnostics. Press keys 1 and 2.</li> <li>-Connect a digital volt meter set on DC Volts with the "+" lead on X1, and the "-" lead on X2 of the LED socket.</li> </ul> <p>Monitor the meter for +24 Vdc. Check both sockets. Is voltage OK?</p> <p><b>Yes</b>-Both LEDs are defective.</p> <p><b>No</b>-Check for proper continuity of cable between the status box and 1J8 on the rear of the monitor.</p> <ul style="list-style-type: none"> <li>-Connect the volt meter to 1J8, "-" lead on pin 17, "+" lead on pin 7 then pin 8. If +24 Vdc is not present, contact AMP Incorporated.</li> </ul> <p><b>IF NO:</b> (Output LEDs 1 and 2 do <u>not</u> light) Contact AMP Incorporated.</p> <p>2. Only <b>one</b> LED fails to light.</p> <p>A. Select I/O Test Diagnostics, press keys 1 or 2 to reset output and indicate OFF on the display.</p> <p>B. Unscrew both LED lenses. Remove LEDs by pressing gently with tip of finger and rotating counterclockwise. LED should now fall from its socket.</p> <p>C. Switch LED positions to confirm failure. Press keys 1 and 2. A faulty LED should now fail in the other position.</p>

PROBLEM	ACTION
<p>Monitor does not detect an undesirable crimp condition.</p>	<ol style="list-style-type: none"> <li>1. Recalibrate for work and force. Increasing the calibration count improves the work and force statistics.</li>   <li>2. Change the work/force coefficients, if necessary.               <ol style="list-style-type: none"> <li>A. Reduce the work and/or force coefficients incrementally until an unacceptable % of false <b>“inspect”</b> errors occur on acceptable crimps.                   <p>In some cases, a small calibration count will not give a stable work and force calibration. Unless false “inspect” errors are occurring on most or all of the initial crimps, crimp additional samples before trying new coefficient settings.</p> </li> <li>B. Increase the coefficients to the previous increment where false inspects did not occur. This is the optimum setting for failure detection.</li> </ol> </li> </ol> <p><b>NOTE:</b> <i>Calibration for work curve history should be done between trials.</i></p>

**6. REVISION SUMMARY**

This document was revised per EC M-3137 and EC-0990-0252-93.

EC M-3137 authorized the following changes:

- Reference to compatibility with AMP Manufacturing Cell Control removed (including SPECIFY REASON FOR DOWNTIME menu).
- The monitor can store information on 100 terminal part numbers – previously read 200 terminal part numbers.
- Added note to calibrate for crimp height after the applicator has been removed/repositioned in the terminating unit.
- Operation of the NEXT key clarified.
- SET OPERATOR ID screen corrected to show only ten characters.
- CELL CONTROL SERIAL PORT screen changed.

EC-0990-0252-93 authorized the following changes:

- New format.
- Customer Manual prefix was changed from CM to 409.
- The EC number was added to title page.
- REVISION SUMMARY was added.



**NOTES:**



---

**APPENDIX A – ERROR MESSAGES****CRIMP START DETECTED**

A Start of Crimp was detected while not in RUN or CALIBRATE mode. Enter RUN or CALIBRATE mode. It is also possible that the applicator is not connected to Crimp Quality Monitor. Check applicator connection.

**\*\*\* DEFECTIVE – NOT ENOUGH VALID POINTS \*\*\* or INVALID CRIMP (CALIBRATE mode)**

While calibrating, the Crimp Quality Monitor detected a crimp but was unable to calculate a valid crimp height. Try another crimp. If you continue to receive this error, there is something wrong with the applicator/crimp monitor. Refer to Section 5, TROUBLESHOOTING.

**EXITING CALIBRATION MODE**

Attempted to exit CALIBRATION mode without entering the number of crimps defined by the calibration count. Press ENTER to continue calibration, RETURN to exit.

**INPUT VALUE IS OUT OF RANGE**

The value input exceeds the range of the variable. Input a value within range of the data field.

**INPUT VALUE OF 0.0000 IS INVALID**

The value of 0.0 is inappropriate for the data field. Input a value greater than 0.0.

**INVALID BAUD RATE SPECIFIED**

An invalid baud rate was entered. Valid baud rates are 600, 1200, 2400, 4800, 9600.

**INVALID CALIBRATION FACTOR**

The Monitor has not been calibrated for the part selected and RUN was entered. Perform a complete calibration, including crimp height calibration.

**INVALID CRIMP**

While in the RUN mode, the Crimp Quality Monitor detected a crimp but was unable to calculate a valid crimp height. Try another crimp.

**INVALID NUMBER OF STOP BITS SPECIFIED**

An invalid number of stop bits was entered. Valid stop bit entries are 10, 15, 20 (for 1, 1.5, 2 stop bits).

**INVALID SAMPLE SIZE**

The sample size is 0. Increase the sample size.

**LOW RAM BACKUP BATTERY – PRESS RETURN**

On power-up, the monitor detected that the RAM backup battery is failing. **To retain memory, the monitor power must remain on until battery is replaced.**

**\*\*\* NO PART NUMBERS AVAILABLE \*\*\***

The part number database is full. Delete any unused part numbers and try again.

**NO PART SELECTED**

RUN or CALIBRATE was selected without first selecting a part number. Select a part number.

**PART NUMBER NOT FOUND IN DATABASE**

The specified part number does not exist in the database. Select a valid part number.

**PASSWORD DOES NOT MATCH**

The password is invalid. Enter the correct password.

**PE**

Printer Error occurs in the RUN mode when there is a printer buffer overload. PE is displayed in the upper right-hand corner of the RUN mode screen when the CTS option is selected and the signal is not provided by the printer, or if the baud rate is too slow.

**PRINTER TIMEOUT OCCURRED**

This occurs in the print test diagnostics when the CTS option is enable and the monitor does not receive a signal on the CTS line.

In addition, there is a printer timeout:

- at the upload of part number database;
- at the upload of crimp data in CALIBRATION mode;
- when printing Batch or Job statistics;
- in the QUIT JOB mode.

**APPENDIX B – CRIMP QUALITY MONITOR SOFTWARE UPGRADE**

**CAUTION** *TO BE PERFORMED BY QUALIFIED PERSONNEL ONLY.*

When changing from software revision 2.00 or higher to the next higher revision, all *part numbers, part histories, height sensor numbers, configurations, and setup values* are retained by the Crimp Quality Monitor as long as the battery on the CPU board is not removed.

As a precaution it is possible to upload the part number and height sensor data bases through the printer port through the EDIT, VIEW, or DELETE screens. Refer to Section 3.1,A through 3.1,F in the monitor manual.

**1. DISCONNECT POWER TO THE MONITOR.**

2. Loosen the two slotted screws in the front bezel.

3. Slide the entire cover forward, off the monitor.

4. Remove the two screws from the hinged printed circuit board and rotate the board to expose the inside of the monitor.

5. Locate the two software proms labelled 856775-1 and 856775-2, (positions U9 and U8 on the processor board).

6. Note the direction of the key indentation then carefully remove both proms and replace with new proms in the *same location and orientation*.

**NOTE** *Ensure all prom legs are inserted into their socket and the key is properly oriented before applying power.*

7. Be sure all cables are properly secured and connected.

8. Secure the hinged circuit board and install the cover.

9. Supply electrical power, turn the monitor ON, and check for the proper display.

## APPENDIX C – PRINTER HOOK-UP FOR THE CRIMP QUALITY MONITOR

### HARDWARE

Only two wires are required in the cable between the Crimp Quality Monitor and the serial port of the printer. If required, a third line can be used for the “Clear to Send” (CTS) option.

---

#### Crimp Quality Monitor — RS232C    Printer Serial Port

<u>1J4</u>	<u>25-D Connector</u>
TX – Pin 3 —————	————— Pin 3 – Receive Data
GND – Pin 5 —————	————— Pin 7 – Signal Ground
CTS – Pin 8 —————	————— Pin 4 – RTS or Pin 20–Busy

---

### CRIMP QUALITY MONITOR SETUP

1. Enter CONFIGURE PRINTING (6) from the CONFIGURATION menu.
2. Select the desired printing options and press ENTER.
3. Return to the CONFIGURATION menu and select PRINTER PORT.
4. Enter the parameters for your particular printer. Refer to Section 3.2.

### TESTING FOR PROPER OPERATION

Enter the DIAGNOSTIC menu (Section 3.4.) and select PRINT TEST (3.4,F). The result of the print diagnostic test should appear as follows:

#### PRINTER TEST

!“#\$%&”()\*+,-./0123456789:;<=>?ABCDEFGHIJKLMN OPQRSTUVWXYZ

#### **NOTE**

*If less than 21 character sets are printed, the baud rate may be set too high, or the CTS line needs to be enabled in the PRINTER SERIAL PORT screen.*

## APPENDIX D – INDEX

TERM	PARAGRAPH	PAGE
A/D CALIBRATION	3.4,H.	31
ASSIGN P/N TO "HOT KEY"	3.2,D.	22
BAD COUNT	3.3.	27
BAD MEAN	3.3.	27
BAD STD DV	3.3.	27
BAUD RATE	3,2,G./ 3.2,H.	25/ 26
BATCH COUNT	2.3./3.2.	8/19
BATCH SIZE	2.3./ 3.2,A.	8/ 15
CAL	2.2.	6
CAL CTRL LIMIT	3.1,B.	12
CALIBRATION COUNT	3.2,B.	20
CELL ADDRESS	3.2,H.	26
CELL CONTROL PORT	3.2,G.	24
CHAR LENGTH	3.2,G.	25
COMMUNICATIONS DIAGNOSTICS	3.4,A.	28
CONFIGURATION	3.2.	14
CONFIGURE PRINTING	3.2,F.	23
CONTROL COUNT	3.2,B.	20
CONTROL LIMIT	3.1,B.	12
CRIMP HEIGHT	3.1,B.	12
DELETE P/N	3.1,C.	13
DIAGNOSTICS	3.4.	28
DISPLAY TEST	3.4,D.	30
EDIT P/N	3.1,B.	11
ENABLE PRINTING	3.2,F.	23
ENABLE PAGING	3.2,F.	23
ENG (0) MET (1)	3.2,B.	20
EVEN PARITY	3.2,G.	25
FORCE COEF	3.1,B.	13
GOOD COUNT	3.3.	26
GOOD MEAN	3.3.	27
GOOD STD DV	3.3.	27
INSPECT COUNT	3.3.	27
I/O DIAGNOSTIC TEST	3.4,G.	31
JOB COUNT	2.3.	8

JOB SIZE	2.3/ 3.2,A.	8/ 18
JOB ID	3.2,A.	17
JOB SETUP	3.2,A.	15
KEYBOARD TEST	3.4,E.	30
LINES PER PAGE	3.2,F.	23
PARITY ENABLE	3.2,G.	25
PASSWORD	3.2,B.	20
PERCENT GOOD	3.3.	27
PRINT BAD HEIGHTS	3.2,F.	23
PRINT END STATS	3.2,F.	23
PRINT GOOD HEIGHTS	3.2,F.	23
PRINT HEADER	3.2,F.	23
PRINT INSPECT HEIGHTS	3.2,F.	23
PRINT INSPECT MESSAGES	3.2,F.	23
PRINT STATISTICS	3.3.	27
PRINT TEST	3.4,F.	30
PRINTER SERIAL PARAMETERS	3.2,G.	24
PRINTER SERIAL PORT	3.2,G.	25
PRINT SUMMARIES	3.2,F.	23
RAM CHECK DIAGNOSTICS	3.4,C.	29
RUN MODE	2.3.	8
SAMPLE SIZE	3.2,B.	20
SELECT P/N	3.2,A.	16
SENSORS (ANALOG) DIAGNOSTICS	3.4,B.	29
SPECIFY DOWNTIME	3.2,E.	23
STOP BITS	3.2,G.	25
SYSTEM SETUP PARAMETERS	3.2,B.	20
TOLERANCE	3.1,B.	12
TOTAL COUNT	3.3.	27
UPLOAD	1.2./2.3./ 3.1,A./3.1,B./3.1,C.	3/ 9/ 11/ 12/ 14
VIEW STATISTICS	3.3.	27
VIEW P/N	3.1,A.	10
WORK COEF	3.1,B.	13